

YOU NEED KEPCO'S PLUG-IN HOT SWAPS WHEN...

...YOUR EQUIPMENT BAY IS SHORT ON SPACE.

Give us 3U x 19" and get:

- (3) 1000W plug-in power supplies or (6) 150W plug-ins or (8) 100W plug-ins or (8) 50W plug-ins or mix the 50, 100 and 150W modules in the rack.

...YOU HAVE TO STAY ON-LINE, NO MATTER WHAT.

Kepeco's plug-in, fault tolerant, hot swap power supplies current share and have built-in or-ing diodes for real N+1 redundancy.

...YOU NEED TO MIX 'N MATCH.

Kepeco's hot swap power supplies range from 3.3~48V; 50, 100, 150 and 1000 watts per module; up to 3000W per 3U rack.



Series HSF 50-150W plug-in modules for multi output or N+1 redundancy



Series HSP 1000W plug-in modules for multi output or N+1 redundancy

LOOK INSIDE FOR PROBLEM SOLVING DETAILS

SERIES HSF

The Kepco HSF series of hot-swappable plug-in power supplies are designed to be combined in an N+1 fault-tolerant power system. Built-in forced current sharing and or-ing diodes are provided for this purpose. HSF may also be used independently as a multi-output power supply.

HSF are designed as plug-ins to a Kepco series RA 19-(X)B rack. The RA 19-6B will accommodate six 150W plug-in modules. The RA 19-8B will accommodate eight 50W or 100W plug-in modules. The RA 19-7B will accommodate three 150W and four 50W or 100W plug-in modules. It will also accommodate four 150W and three 50W or 100W plug-in modules.

The front panel of each plug-in HSF module contains an on-off switch and a "V d-c on" light. When HSF modules are paralleled, the module with the highest voltage setting automatically becomes the "master" (indicated by the front panel "master on" light). The other units are slaves, track the voltage setting of the master and equally share the load current. The front panel voltage adjustment trimmer provides adjustment of the output voltage. A pair of test points provide access at the front panel to measure the voltage.



**FIGURE 1:
OUTPUT POWER RATING
VS. AMBIENT TEMPERATURE**

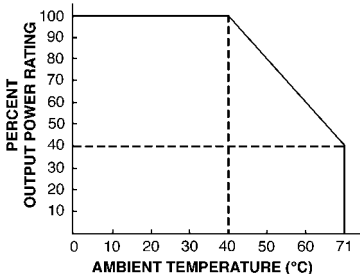

HSF MODEL TABLE

MODEL	OUTPUT VOLTS	ADJUSTMENT RANGE	OVP SETTING (VOLTS)	OUTPUT CURRENT AMPS 0-50°C	CURRENT LIMIT (AMPS)	SW RIPPLE mV		NOISE (spike) mV max
		typ	max					
50 WATT MODELS								
HSF 5-10	5	4.5-5.5	7.0~8.0	0-10.0	10.5~12.0	30	60	<120
HSF 12-4.2	12	11.4-12.6	13.7~15.7	0-4.2	4.4~5.1	35	70	<190
HSF 15-3.4	15	13.5-16.5	17.0~19.0	0-3.4	3.6~4.1	45	90	<220
HSF 24-2.1	24	22.5-25.5	27.0~30.5	0-2.1	2.2~2.6	50	100	<310
HSF 48-1	48	45.0-51.0	53.5~60.0	0-1	1.1~1.3	60	150	<350
100 WATT MODELS								
HSF 5-20	5	4.5-5.5	7.0~8.0	0-20	21.0~24.0	30	65	<120
HSF 12-8.3	12	11.4-12.6	13.7~15.7	0-8.3	8.7~10.0	35	70	<190
HSF 15-6.6	15	13.5-16.5	17.0~19.0	0-6.6	7.0~8.0	40	80	<220
HSF 24-4.2	24	22.5-25.5	27.0~30.5	0-4.2	4.4~5.2	50	110	<310
HSF 28-3.5	28	26.5-29.5	32.0~35.0	0-3.5	3.7~4.2	60	140	<330
HSF 48-2	48	45.0-51.0	53.5~60.0	0-2	2.1~2.4	80	220	<530
150 WATT MODELS								
HSF 5-30	5	4.5-5.5	7.0~8.0	0-30	32.0~36.0	30	60	<120
HSF 12-12	12	11.4-12.6	13.7~15.7	0-12	13.0~15.0	35	70	<190
HSF 15-10	15	13.5-16.5	17.0~19.0	0-10	11.0~13.0	40	80	<220
HSF 24-6	24	22.5-25.5	27.0~30.5	0-6	6.3~7.5	50	110	<310
HSF 28-5	28	26.5-29.5	32.0~35.0	0-5	5.3~6.1	60	140	<330
HSF 48-2.8	48	45.0-51.0	53.5~60.0	0-2.8	3.0~3.5	80	220	<530

(1) Current limit is a rectangular type, not foldback.

HSF GENERAL SPECIFICATIONS

SPECIFICATION	RATING/DESCRIPTION	CONDITION	
Temperature	0° to 71°C (see figure 1)	Operating	
	-40°C to +85°C	Storage	
Humidity	Up to 95% RH	Non-condensing Operating & storage	
Shock	20g, 3 axes (11msec ±5msec pulse duration)	Non-operating 3 shocks each axis	
Vibration	5-10Hz: 10mm amplitude 3 axes	Non-operating 1 hour each axis	
	10-55Hz: 2g, 3 axes		
Isolation	Output-Case	500V d-c, 100M Ohm	25°C, 65% RH
Type of construction	Plug-in		
Cooling	Convection		
	Withstand voltage	Input-Output	3.75KV a-c for 1 minute
50W	Input-Case	2KV a-c for 1 minute	
Withstand voltage	Input-Output	3KV a-c for 1 minute	25°C, 65% RH Y caps removed
	100W,150W	Input-Case	
Safety	UL 1950; EN 60950; CSA 22.2 No. 950-95		



HSF are CE marked per the Low Voltage Directive (LVD), EN60950



FEATURES

- **Built-in EMI filter:** Attenuates the conducted noise below the requirements of both FCC and VDE 0871 for Class B computing devices.
- **Remote error sensing:** All HSF provide separate remote error sense terminals: 0.25V drop/wire.
- **Forced current share:** Used to configure an N+1 system. When the current share bus of paralleled HSF are connected together, the load current divides equally. If one unit fails, the remaining units will divide the load equally among themselves and continue to supply uninterrupted current to a critical load. The failed unit is isolated by built-in or-ing diodes.
- **Alarm:** A built-in relay provides either normally open (close on failure) or normally closed (open on failure) contacts that may be used to provide an external failure indication.
- **Plug-in connector:** The HSF obtain mains power and provide output via a 24 pin connector that mates with a corresponding connector in the rack adapter.
- **Keying:** The HSF are keyed according to their voltage rating. When the corresponding rack adapter key (pin) is installed by a user, only an HSF of the correct voltage can be inserted into the keyed slot.
- **Safety:** Designed to meet UL 1950, CSA C22.2 No. 234 (M90) level 3 and EN 60950 (a-c input only).



FAW 100W Model

For applications that do not require hot-swap plug-in capabilities, see Kepco FAW-series power modules. They bolt to your chassis and provide a stable 15, 25, 50, 100 or 150W output.

HSF INPUT CHARACTERISTICS

SPECIFICATION		RATING			CONDITION
a-c Voltage	nom	120-240V a-c			Single phase
	range	95-264V a-c			
d-c Voltage	range	125-370V d-c(1)			Polarity insensitive
Brown-out voltage	min	85V a-c/110V d-c			Ripple, source and load effect increase
Frequency	nom	50-60Hz			Single phase
	range	47-440Hz(2)			
EMI		FCC and VDE 0871			Conducted Class B
Soft-start circuit		Thermistor or thyristor limiter			
Leakage current	max	0.5mA UL method			120V a-c 50-60Hz
	max	0.75mA VDE method			240V a-c 50-60Hz
Startup time	max	50W<500ms			From turn on until d-c output reaches nominal
		100 & 150W<200ms			
Holdup time	typ	20msec			120V a-c
	min	15msec			100V a-c
INPUT CURRENT					
(Amperes)					
a-c Current	typ	50W	100W	150W	120V a-crms
		max	1.2	2.4	
	max	50W	100W	150W	240V a-c rms
		typ	0.5	1.0	
Fuse value		3.0	5.0	6.3	250V type 5x20mm
Initial turn-on surge, first half cycle		45	45	45	120V a-c rms
		90	90	90	240V a-c rms
Efficiency	typ %	76	76	76	Max load, nominal output
Circuit type		Forward Converter			
Switching frequency	typ	120KHz			Nominal load

(1) Note: Safety agency approvals are valid only for a-c input because of the fuse rating

(2) At 440Hz the leakage current exceeds the UL safety specification

HSF OUTPUT CHARACTERISTICS

SPECIFICATION		RATING		CONDITION
Source Effect	typ	1.0%		95-132 or 190-264V a-c
	max	2.0%		
Load Effect	typ	1.0%		10% to 100% load
	max	2.0%		
Temperature Effect	typ	1.0%		Nominal input, rated load 0-40°C
	max	2.0%		
Combined Effect	typ	2.0%		Includes source, load and temperature
	max	4.0%		
Time Effect (drift)	typ	0.1%		0.5-8.5 hr, max load, 25°C
	max	0.5%		
Recovery Characteristic	excursion	<±4%		Step load 50-100%, rise time >50µs
	recovery	2ms		



ACCESSORIES FOR HSF MODELS

OUTLINE DIMENSIONAL DRAWINGS

Fractional dimensions in light face type are in inches.
are in inches.

Dimensions in bold face type are in millimeters.

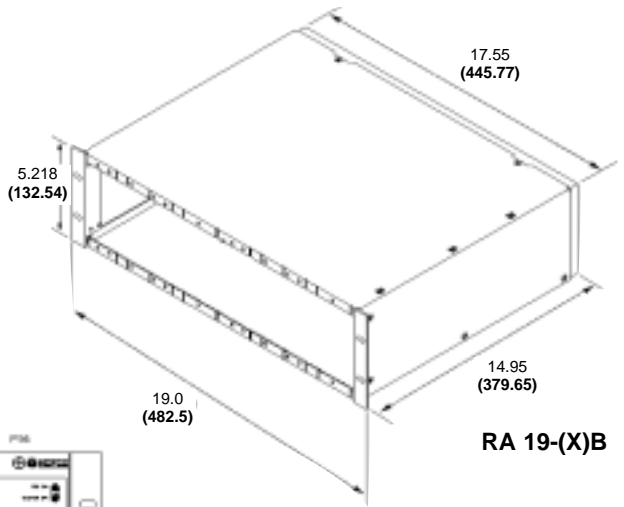

RA 19-(X)B



RA 19-6B Rack Adapter with (6) 150W HSF Installed

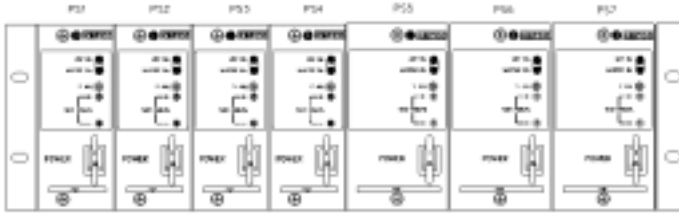

RA 19-7B Rack Adapter with (4) 100W and (3) 150W HSF Installed



RA 19-8B Rack Adapter with (8) 100W HSF Installed

RA 19-(X)B ACCESSORIES

Accessory	Part Number	Use
Filler Panel 1/24 Rack	RFP 19-24	Cover unused 1/24 rack slots
Filler Panel 1/12 Rack	RFP 19-12	Cover unused 1/12 rack slots
Filler Panel 1/8 Rack	RFP 19-18	Cover unused 1/8 rack slots
Filler Panel 1/6 Rack	RFP 19-16	Cover unused 1/6 rack slots
Filler Panel 2/8 Rack	RFP 19-28	Cover unused 2/8 rack slots
Filler Panel 2/6 Rack	RFP 19-26	Cover unused 2/6 rack slots
Filler Panel 3/8 Rack	RFP 19-38	Cover unused 3/8 rack slots
Filler Panel 1/2 Rack	RFP 19-48	Cover unused 1/2 rack slots

Weights

RA 19-(X)B
50W
100W
150W

English

22 lbs
4 lbs
5 lbs
5.5 lbs

Metric

10Kg
1.8Kg
2.3Kg
2.5Kg

RA 19-8B Rack Adapter Rear Panel

This is the standard rear panel configuration. Other connector options are available. Please consult the factory.

The I/O Connector functions are brought out as follows:

- 1- Error sense (+S, -S) for each position.
- 2- Output voltage (+V, -V) for each position to permit wiring for local sense.
- 3- Current share bus (one) connection brought out for each pair of modules. (Each pair internally connected using DIP switches on the backplane).
- 4- Output status alarm contacts (Form C) for each position.

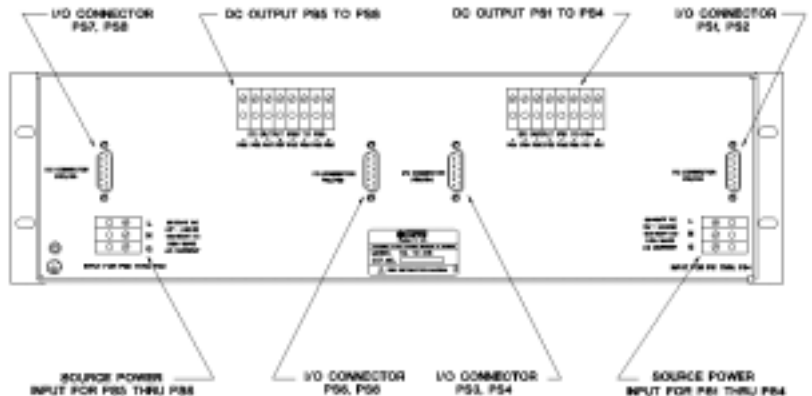

SERIES HSP

The Kepco HSP series comprises a group of ten models, seven 1000 watt power supplies with outputs from 3.3 volts to 48 volts and three 1500 watt power supplies with outputs from 24 volts to 48 volts. All models feature current-sharing for parallel redundant N+1 operation. Models with the or-ing diode, option R, are capable of hot swapping when plugged into Kepco's RA 60 series rack adapters. A mechanical keying scheme allows the user to define which power supply will plug into a specified slot in the housing. Output voltage and current limit settings are adjustable from the panel and may also be remotely adjusted.

The 1000 watt HSP have a wide range a-c input (90-277V a-c). The 1500 watt models operate from 180-277V a-c mains. Both feature an active power factor correction (PFC) front end to suppress harmonic generation per EN 60555-2 and EN 61000-3-2.

HSP have optional built-in "or-ing" diodes for redundancy paralleling and a "hot-swap" capability. These are specified by appending the suffix "R" to the model number.

Three HSP models shown in RA 60 Housing



HSP INPUT CHARACTERISTICS

SPECIFICATIONS		RATING/DESCRIPTION	CONDITION
a-c Voltage 1000W models	nominal	100-250V a-c	Single phase
	range	90-277V a-c	Wide range
a-c Voltage 1500W models	nominal	200-250V a-c	Single phase
	range	180-277V a-c	Wide range
d-c Voltage ⁽¹⁾	1000W	125-420V d-c ⁽¹⁾	Polarity insensitive
	1500W	250-420V d-c ⁽¹⁾	Polarity insensitive
Brownout Voltage	1000W	75V a-c	
	1500W	150V a-c	
Source Frequency		47-440Hz	>63Hz, input leakage current exceeds tabulated value
Source Current	120V a-c	1000W: 11.0A rms	Typical
	240V a-c	1000W: 5.5A rms 1500W: 8.0A rms	
Power Factor	Typical	0.99	
	Minimum	0.96	

(1) Safety approval is for a-c operation only.



HSP are CE marked per the Low Voltage Directive (LVD), EN60950



HSP MODEL TABLE

SPECIFICATION	OUTPUT VOLTAGE		OVP SETTING	RATED OUTPUT CURRENT			RIPPLE		NOISE	EFFICIENCY
	Unit	Volts	Volts	Amps			mV p-p		mV p-p	Percent
Condition	Factory Set	Adjustment Range	Factory Setpoint	50°C	60°C	71°C	Source max	Switching max	(Spike) 20MHz	100% Load Nominal input
1000 WATT MODELS										
HSP 3.3-230	3.3	2.3-3.6	4.29	230	173	105	20	30	100	71
HSP 5-200	5	3.5-5.5	6.5	200	150	95	20	30	100	72
HSP 12-84	12	8.4-13.2	15.6	84	63	40	20	40	120	73
HSP 15-66	15	10.5-16.5	19.5	66	49.5	31.4	20	40	150	76
HSP 24-42	24	16.8-26.4	31.2	42	31.5	20	20	60	240	77
HSP 28-36	28	19.6-30.8	36.4	36	27	17	20	60	280	78
HSP 48-21	48	33.3-59.2	62.4	21	16	10	20	60	480	80
1500 WATT MODELS										
HSP 24-60	24	16.8-26.4	31.2	60	45	28.6	20	60	120	77
HSP 28-53	28	19.6-30.8	36.4	53	39.8	25.2	20	60	140	78
HSP 48-30	48	33.3-59.2	62.4	30	22.5	14.3	20	60	240	80

FEATURES

- Remote sensing.
- Control/programming of voltage, current, current limit and OVP.
- Current walk in control.
- Safety agency approvals: UL 1950, CSA 22.2 no. 234, VDE EN 60950.
- HSP meet ANSI C62.41/EN 61000-4-5 guidelines for with-standing surges on the mains.
- HSP are ~ 5" x 5" cross-section plug-ins that mount three abreast in a standard 5.25" x 19" rack adapter. Output voltage settings and current limit can be pre-set so an HSP can be plugged in without powering down the system.
- HSP are fully protected for any overload including a short circuit. Normal overload protection is continuous current limiting. A switch selectable option will latch the power off after 20 seconds to avoid damage to load wires. An overvoltage protector latches the power off whenever the output exceeds a user-set limit.
- Remote control of HSP is provided via one of two isolated TTL-level signals, one normally high and the other normally low. An internal 5V supply powers this circuit and provides the auxiliary 5V, 100mA output. This voltage is available whenever source power is applied whether or not the main output is inhibited. The main output is normally ON if no remote logic is applied. The main output voltage is remotely trimmable by resistance. Both the output voltage and current limit are adjustable over the range 20%-100% by a 0-10V analog voltage.

HSP OUTPUT CHARACTERISTICS

SPECIFICATIONS		RATING/DESCRIPTION	CONDITION
Output setting range		-30% to +10%	Of nominal output
		-30% to +25%	48V Models only
Source effect	typ	0.05%	Nominal ± 15%
	max	0.1%	
Load effect	typ	0.05%	5%-100% load operation between 0-5% load results in increased ripple and degraded transient response
	max	0.1%	
Temperature effect	typ	0.01%	Per degree C (0 to 50°C)
	max	0.02%	
Combined effect (source, load temperature & time)	typ	0.15%	
	max	0.3%	
Time effect (drift)	typ	0.05%	0.5-8.5 hours
	max	0.1%	
Start up time	max	1 second	Any source/load
Recovery characteristics	Excursion	<3% of Nominal Output	50-100% load
	Recovery	1000W: 100 µsec 1500W: 300 µsec	Return to 1% of setting
Ride through	min	21.5 Milliseconds	From loss of source to flag signal
Hold-up time	min	5 Milliseconds	After signal flag
Overshoot	turn on	+3% max	Any source 5%-100% load
	turn off	none	
Error sense	3.3 & 5V	0.25V	Voltage allowance per wire
	All others	0.4V	
Series connection (output floats)		500V	Maximum voltage off ground
Parallel connection (for redundancy)		Current shares within 5% of rated load	5-100% load, hot-swappable
Selective overvoltage shutdown		Adjustable 100-140% of nominal; factory set to 130%	Latched, reset by cycling source power off
Current limiting		Constant current mode Factory set 110% of I _o max	Optional shutdown mode with 20 second delay
Remote on/off	RC-1	Normally high	Isolated form C or TTL
Remote on/off	RC-2	Normally low	Isolated form C or TTL
Over temperature		Thermostat, auto re-start	With hysteresis

HSP GENERAL SPECIFICATIONS

SPECIFICATIONS		RATING/DESCRIPTION	CONDITION
Temperature		-20° to +71°C (see model table)	Operating
		-40° to +85°C	Storage
Humidity		0 to 95% RH	Non condensing operating & storage
Shock		20g 11msec ±50% half sine	Non-operating 3-axes 3 shocks each axis
Vibration		5-10Hz 10 mm double amplitude	Non operating 1 hour each axis
		10-55Hz 2g	
Altitude	operating	Sea level to 10,000 ft	
	storage	Sea level to 160,000 ft	
Isolation	Output-case	500V d-c	25°C, 65%RH
Withstand voltage	Input-output	3000V a-c rms	25°C, 65%RH
	Input-case	1500V a-c rms	
Safety		UL 1950; VDE EN 60950; CSA 122.2 No. 234-M90 level 5	Information Technology Equipment
Type of construction		Enclosed, plug-in style includes status LEDs, circuit breaker, handle, voltage/current trimmers, monitor test points	Stand alone or rack mountable into RA 60 Accommodates up to 3 units
Cooling		Internal d-c fan	Exhaust to rear



AN ISO 9001 COMPANY

KEPCO®

THE POWER SUPPLIER™
SINCE 1946

KEPCO, INC. • 131-38 SANFORD AVENUE
FLUSHING, NY 11352 USA
(718) 461-7000 • FAX: (718) 767-1102
E-MAIL: hq@kepcopower.com
URL: <http://www.kepcopower.com>



Rear View of the HSP plug-in module



Rear view, cover removed, of the rack housing showing the heavy-duty bus-bar connections that make HSP's "Hot Swap" practical. Note: The a-c input connector is supplied with a mating connector, too.



Series HSM
Modular version for
hard wired applications

For applications that do not require hot-swap plug-in capabilities, see Kepco Series HSM power modules. They bolt to your chassis and provide a stable 1000W output.

HSP SIGNALS AND FLAGS

SPECIFICATIONS	RATING/DESCRIPTION		CONDITION
Status Flags (Form C dry relay contacts)	POWER	Indicates low source voltage signal asserted 5 msec prior to loss of output voltage	Both NO and NC available
	OUTPUT	Indicates normal operation	
	OVER TEMP	Over temperature shutdown	
	FAN FAIL	Failure of internal fan	
Status Indicators front panel LEDs	POWER	Green	Lit when a-c is sufficient
	DC FAIL	Red	Lit when output failure is detected
	OVER TEMP	Yellow	Lit when thermostat activates
	FAN FAIL	Red	Lit when fan failure is detected

HSP CURRENT HARMONICS, SOURCE TRANSIENTS AND EMI SPECIFICATIONS

PARAMETER	DOCUMENT	SPECIFICATION
IMMUNITY⁽¹⁾		
Radiated RF (Ampl. mod.)	EN 61000-4-3	10V/m, 80-1000MHz
Radiated RF (Pulse mod.)	EN 61000-4-3	10V/m, 900MHz
Magnetic Field	EN 61000-4-8	30A/M, 50Hz
Electrostatic Discharge	EN 61000-4-2	4KV (contact) 8KV (air)
Conducted RFI	EN 61000-4-6	10Vrms, 0.15-80MHz
Electrical Fast Transient	EN 61000-4-4	2KV, Tr/Th = 5/50ns
Surge (CM, DM)	EN 61000-4-5	4KV (CM) Tr/Th = 8/20µs 2KV (DM) Tr/Th = 8/20µs
EMISSIONS		
Conducted RF	FCC Class A CISPR 22, Class A	0.45-30MHz 0.15-30MHz
Current Harmonics	EN 60555-2 and EN 61000-3-2	0-2KHz

(1) All immunity levels meet the requirements for heavy industrial applications per EN 50082-2 using Criteria A (no operational effect).

HSP PHYSICAL CHARACTERISTICS

SPECIFICATIONS	RATING/DESCRIPTION		CONDITION
Dimensions	English	5.38" x 5.22" x 16"	Excluding front latch, circuit breaker, handle and rear connections
	Metric	137 x 133 x 406 mm	
Weight	English	19lbs	
	Metric	8.6Kg	
Source connection	3 pin IEC connector		Compatible with molded line cord
Load connection	Two bus bars 1.25" x 0.125" x 2.5"		Keyed for plug-in housing
Signal connection	37 Pin D-subminiature connector		

Use The Reverse Side To Tell Us Your Needs

Enclose in an envelope and mail or fax to:

REGIONAL OFFICES

HEADQUARTERS / EASTERN REGION: KEPCO, INC.
131-38 Sanford Avenue, Flushing, NY 11352 USA
Tel: (718) 461-7000 • Fax: (718) 767-1102
E-Mail: hq@kepcopower.com • URL: http://www.kepcopower.com

WESTERN REGION: KEPCO, INC.
800 West Airport Freeway, Suite 320 LB 6018
Irving, TX 75062 USA • Tel: (972) 579-7746
Fax: (972) 579-4608 • E-Mail: kepcotx@aol.com

DIRECT SALES OFFICE

KEPCO, INC., PENNSYLVANIA
336 Bala Terrace West, West Chester, PA 19380
Tel: (610) 594-0856 • Fax: (610) 594-8023
E-Mail: powerman@netreach.net

SALES REPRESENTATIVES

HARRY LEVINSON COMPANY Seattle, Washington (Main Office)
Tel: (206) 382-1300 • Fax: (206) 382-0186
E-Mail: hickam@aol.com *Also covers Canada West (BC)*

N-S WESTRONICS - Sunnyvale, California
Tel: (408) 745-1102 • Fax: (408) 745-1106
E-Mail: nsw@pacbell.net

SYNERTEK MARKETING - Arcadia, California
Tel: (818) 357-0371 • Fax: (818) 303-5796
E-Mail: main@synertekmkt.com

EARLE ASSOCIATES INC. - San Diego, California
Tel: (619) 278-5441 • Fax: (619) 278-5443
E-Mail: earle.associates.distrib@symbios.com

AZTEC ENTERPRISES, INC. Denver, Colorado (Main Office)
Tel: (303) 779-5285 • Fax: (303) 779-5334
E-Mail: 105050.3447@compuserve.com

BASE EIGHT, INC. - Bloomington, Minnesota (Western Region)
Tel: (612) 941-5888 • Fax: (612) 941-5757
E-Mail: rhoran@base8.com

BASE EIGHT, INC. - Arlington Heights, Illinois (Eastern Region)
(Main Office) Tel: (847) 670-1680 • Fax: (847) 670-1737
E-Mail: 75117.3565@compuserve.com

TECREP CORPORATION - Hazelwood, Missouri
Tel: (630) 627-9110 • Fax: (630) 627-9129
E-Mail: tccrk@aol.com

DATA MARKETING ASSOC. INC. Dallas, Texas (Main Office)
Tel: (972) 661-0300 • Fax: (972) 490-0836
E-Mail: dma@cyberramp.net

STAR ENGINEERING SALES CORP. - Milwaukee, Wisconsin
Tel: (414) 645-3680 • Fax: (414) 383-1301
E-Mail: starengs@exepc.com

EQS SYSTEMS Chesterland, Ohio (Main Office)
Tel: (216) 729-2222 • Fax: (216) 729-2257
E-Mail: sales@eqssystem.com

W.A. BROWN INSTRUMENTS INC. Orlando, Florida (Main Office)
Tel: (407) 648-9660 • Fax: (407) 839-0337
E-Mail: jtconnell@aol.com

EASTERN INSTRUMENTATION CORP. - Washington, D.C.
Tel: (301) 384-8500 • Fax: (301) 421-1730
E-Mail: gene@eicorp.com

RAY PERRON & CO., INC. Boston, Massachusetts (Main Office)
Tel: (617) 449-6162 • Fax: (617) 444-1074
E-Mail: sales@rpc-inc.com

NORTHERN TECHNICAL SALES - Pittsford, New York
Tel: (716) 385-6480 • Fax: (716) 385-7546
E-Mail: ntsoffice@aol.com

CONTECH INSTRUMENTATION INC.
Northern NJ, NY metro, Westchester, Rockland
Tel: (908) 744-2500 • Fax: (908) 744-2505
E-Mail: contech@soho.ios.com

MULTITEST ELECTRONICS INC. - CANADA, EAST
Scarborough, Ontario (Main Office)
Tel: (416) 609-8396 • Fax: (416) 609-8399

PLEASE FILL IN THIS CARD TO RECEIVE MORE INFO
FAST ON KEPCO HSF/HSP POWER SUPPLIES.

MAIL OR FAX TO NEAREST ADDRESS.

146-1869



QUOTE ME

I need the following models, and quantities.



CALL ME

My application is:



I WANT

a free demo.



SEND ME

Kepeco's Full-line Catalog on Instrumentation and Modular Power Supplies for System, Bench and the OEM, #146-1862



Name _____ M/S _____ Title _____
(First) (Last)

Company _____ Dept. _____

Address _____

City _____ State _____ Zip _____

Phone () _____ Fax No. () _____

PLEASE FILL IN THIS CARD TO RECEIVE MORE INFO
FAST ON KEPCO HSF/HSP POWER SUPPLIES.

MAIL OR FAX TO NEAREST ADDRESS.

146-1869



QUOTE ME

I need the following models, and quantities.



CALL ME

My application is:



I WANT

a free demo.



SEND ME

Kepeco's Full-line Catalog on Instrumentation and Modular Power Supplies for System, Bench and the OEM, #146-1862



Name _____ M/S _____ Title _____
(First) (Last)

Company _____ Dept. _____

Address _____

City _____ State _____ Zip _____

Phone () _____ Fax No. () _____

ACCESSORY HOUSINGS FOR HSP MODELS

RA 60

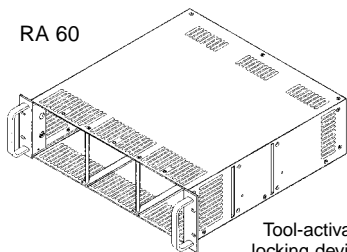

Tool-activated locking devices mount HSP modules

RA 60

19" Rack (3) HSP Modules
3 slots wired in parallel for redundancy
hot swap connectors

RA 62

19" Rack (3) HSP Modules
2 slots wired in parallel,
1 independent
hot swap connectors

RA 63

19" Rack (3) HSP Modules
independent slots
hot swap connectors

RA 58

19" Rack (3) HSP Modules
independent slots, hardwire

To configure the above rack housings for 23" or 24" wide rack cabinets, add suffix -23E or -24E respectively

RA 59

24" Rack (4) HSP Modules
4 slots wired in parallel
hot swap connectors

RA 61

24" Rack (4) HSP Modules
independent slots, hardwire

RA 59

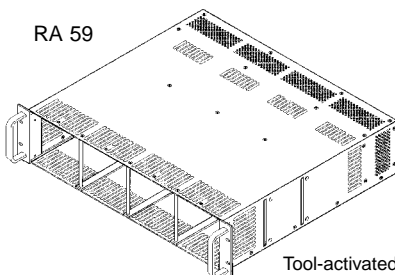

Tool-activated locking devices mount HSP modules

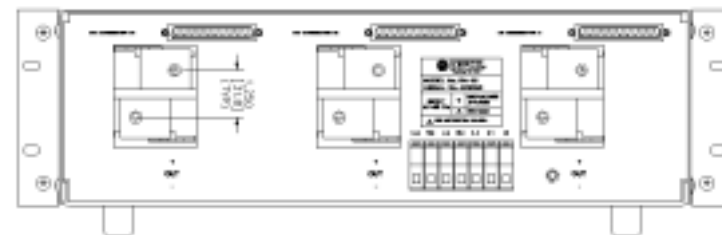
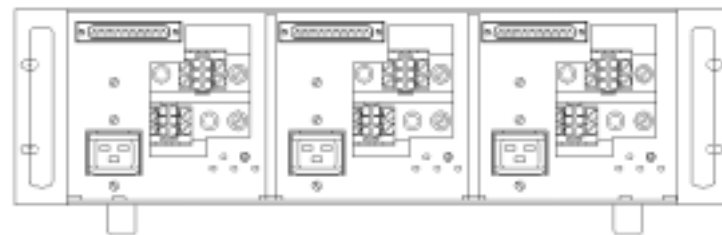

RA 60 front view (top), RA 60 rear view (bottom)

OUTLINE DIMENSIONAL DRAWINGS FOR HSP PLUG-IN MODULES

Fractional dimensions in light face type are in inches. dimensions in bold face type are in millimeters.

Tolerance: $\pm 1/64"$ (0.4) between mounting holes
 $\pm 1/32"$ (0.8) other dimensions

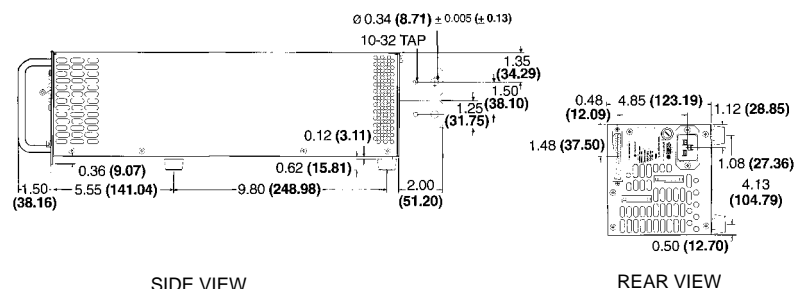
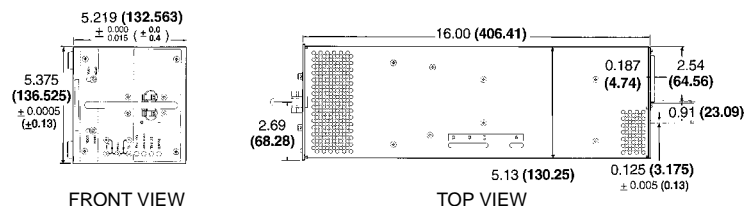

HSP ACCESSORIES

- 118-0776 line cord set with NEMA 5-20P termination (125V/20A)
- 142-0381 source power entry mating connector
- 142-0422 I/O mating connector
- 108-0203 I/O connector jackposts (set of two)
- 108-0296 I/O connector shell
- 101-0159 screw for mounting plastic feet



KEPCO, INC. • 131-38 SANFORD AVENUE • FLUSHING, NY 11352 USA • (718) 461-7000 • FAX: (718) 767-1102
E-MAIL: hq@kepcopower.com • URL: <http://www.kepcopower.com>