

INSTRUCTION MANUAL

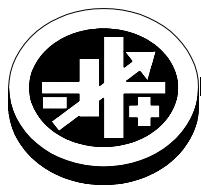

KEPCO An ISO 9001 Company.

HSF-1UR
50W SERIES



KEPCO SINGLE OUTPUT, 1U, 50 WATT HOT SWAP PLUG-IN POWER SUPPLIES

I — INTRODUCTION

The Kepco HSF-1UR, 50 Watt Series hot swappable, high frequency switching, plug-in power supplies with built-in power factor correction (PFC) employ forward conversion and are designed to operate in a fault tolerant power system with either a-c or d-c input. A thermistor soft-start circuit limits start-up surge. Built-in OR-ing diodes (all models) and a forced current share circuit (all models except 3.3V) allow configuration of all models for hot-swap and parallel-redundant N+1 operation. Outputs of 3.3, 5, 12, 15, 24, 28 or 48V are available (see Table 1).

These power supplies are designed to be used with Kepco's Series RA 19-1U rack adapters. The RA 19-1U rack adapter accepts up to four 50 Watt, 100 Watt or 150 Watt units (see Figure 2). All input/output connections are through a 24-pin connector that plugs in to the rack adapter. All external connections are made through the rack adapter. I/O signals and implementation of HSF options are described in detail in the RA 19-1U Rack Adapter Manual. Surface mount technology permits efficient component layout for minimum mounting space.

EMI filtering is designed to meet FCC Class B rating and VDE 0871 Class B rating. Table 1 contains specifications that vary for each model of the HSF-1UR 50 Watt Series. Common specification are listed on page 5.

II — FEATURES

FRONT PANEL ACCESS. The front panel provides a power ON/OFF switch controlling input power and a "VDC ON" light which indicates when the unit is operating. **NOTE: The ON/OFF switch must be set to OFF before removing unit from rack adapter.** The front panel "MASTER ON" LED lights when 1) the unit operates independently, or 2) the unit is used in parallel redundant configurations while a) the output is less than 10% of nominal or b) the output is within 10% to 100% of nominal and the unit is functioning

OPTIONS. There are four options available: T, C, X and Y. Features for all models are the same, except as follows:

The heart of the standard 50W HSF-1UR (no options) models is a Kepco RKW power supply (28V model not available).

T option (-1URT) models use a Kepco RTW power supply instead of the RKW. T option models weigh less, and have improved efficiency (input current) specifications. All voltages are available.

C option (-1URC) models include a current sensing resistor, allowing external current monitoring within $\pm 10\%$ (contact Kepco if greater accuracy required). In addition, a 28V model is available with Option C. All voltages are available.

X option (-1URX) remote control models are identical to T option, but also include the ability to turn the unit on and off from a remote location. All voltages are available.

Y option models (-1URY) are identical to T option, but also include both current monitoring and remote on-off capabilities. All voltages are available.

When the input is cut off, the output is maintained for 15 milliseconds minimum (25 for T, C, X and Y models). If the power supply shuts down due to an output overvoltage condition, it is then necessary to wait 60 seconds minimum (30 for T, C, X and Y models) before turning the unit on again.

as a master. In parallel redundant configurations, the module with the highest voltage functions as the master. The other units are slaves, and track the output voltage of the master. Refer to **Current Share Bus (CSB)** on page 4 for details. The front panel Vadj trimmer provides adjustment of the output voltage within the limits specified in Table 1; test points connected to the +S and -S lines are available at the front panel for measuring the output.

TABLE 1. OUTPUT RATINGS AND SPECIFICATIONS, HSF-1UR 50W SERIES

HSF MODEL	HSF 3.3-10-1UR (1) (2)	HSF 5-10-1UR (1)	HSF 12-4.3-1UR (1)	HSF 15-3.5-1UR (1)	HSF 24-2.2-1UR (1)(8)	HSF 28-1.8-1UR (6)	HSF 48-1-1UR (1)
OUTPUT VOLTS, d-c (NOMINAL)	3.3V	5V	12V	15V	24V	28V	48V
ADJUSTMENT RANGE	2.8 - 3.4V	4.3 - 5.3V	11.4 - 12.6V	13.5 - 16.5V	22.5 - 25.5V	22.4 - 30.2V	45 - 51
OUTPUT CURRENT (NOMINAL) ⁽³⁾	10A	10A	4.3A	3.5A	2.2A (3.2A Peak ⁽⁸⁾)	1.8A	1.1A
CURRENT LIMIT ⁽⁴⁾	10.5A min	10.5A min	4.5A min	3.6A min	3.3A min (2.3A Min) ⁽⁹⁾	1.9A min	1.15A min
OUTPUT POWER (MAX.) ⁽⁵⁾	33W	50W	51.6W	52.5W	52.8W	50.4W	52.8W
SHORT CIRCUIT CURRENT ⁽⁴⁾	15A	12.6A	5.6A	5.4A (4.5 ⁽⁶⁾)	6.2A (3A ⁽⁶⁾)	2.5A (1.7 ⁽⁶⁾)	2.4A
RIPPLE AND NOISE (mV p-p) 0-40°C, 10-100% LOAD	switching (typ)	80	80	100	100	150	130
	spike noise (d-c—50MHz)	120	120	150	150	200	200
OVERVOLTAGE SETTING (25°C, NOM. INPUT)	3.9 - 5.1V	5.7 - 6.4V	13.5 - 15.5V	16.8 - 18.8V	26.8 - 30.3V	32.0 - 35.0V	54.8 - 59.9V
Sense Resistor (Rs) Value ⁽⁷⁾	0.01 Ohm	0.01 Ohm	0.02 Ohm	0.03 Ohm	0.05 Ohm	0.05 Ohm	0.1 Ohm

- (1) Unless otherwise noted, specifications are identical for all options.
- (2) Forced current Share not available for 3.3V Models.
- (3) Derates same as Output Power.
- (4) Current Limit is rectangular. After the overload is removed, output is automatically restored.
- (5) See power derating curve, Figure 5.

- (6) 28V Model available with T, C, X and Y Options only.
- (7) Sense resistor included on C and Y Models only (see "Remote on-off." on page 3 for Y option details).
- (8) Peak current and thermal protection applicable to 24V standard (no options) and C option models only. See Figure 1 for peak power requirements.
- (9) For 24V Model, T, X and Y option only.)

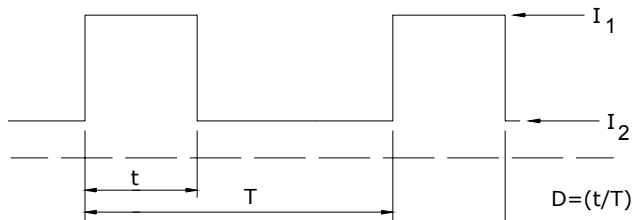

3043527

Standard (no options) and C option 24V Models can supply Peak current listed in Table 1 if the four conditions listed below are met. This model includes thermal protection, voltage shutdown type. Restart by removing a-c input; after sufficient cooling, reapply a-c input (wait at least 30 seconds).

1. Time: $t \leq 10$ Seconds
2. $I_1 \leq$ Peak Current (Amperes)
3. Effective Current:

$$\sqrt{DI_1^2 + (1-D) \times I_2^2} \leq \text{Rated current (Amperes)}$$

4. Effective Power $P \leq$ Maximum Power (Watts)
(output RMS current x output voltage)

FIGURE 1. 24V MODEL PEAK CURRENT REQUIREMENTS

BUILT-IN OR-ING DIODES. OR-ing diodes allow configuration of all models for hot-swap and parallel-redundant N+1 operation where current distribution is not equal and the idle unit takes over in the event of failure.

FORCED CURRENT SHARE CIRCUIT. (Not applicable to 3.3V models.) When units are configured for N+1 parallel redundant operation, it is desirable for current to be divided equally among the paralleled supplies. When the CSB (forced Current Share Bus) lines of paralleled HSF-1UR units are connected together, the load current is forced to divide equally between all paralleled units; units operate at less than maximum, reducing stress and increasing reliability of the system. If one unit fails, the remaining units will continue to supply the load, and the load current will be divided equally among the remaining operating units. The failed unit is automatically isolated from the circuit by a built-in isolation diode. Refer to **Current Share Bus (CSB)** on page 4 for details.

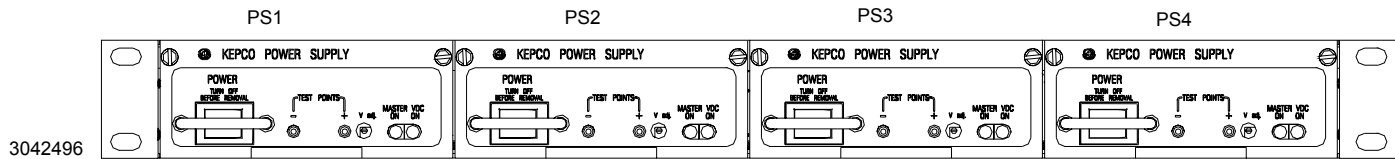

FIGURE 2. HSF-1UR 50 WATT POWER SUPPLIES (4) INSTALLED IN RA 19-1U RACK ADAPTER

REMOTE ON-OFF. Remote on-off (X and Y models only) is via \pm RC assigned to pins of the RA 19-1U I/O connector: off = no voltage, short circuit, or 0 to 0.8V, on = 4.5 to 12.5V (or 12.5 to 24.5V via 1.5K Ohms). To reverse on-off polarity contact Kepco. There is no isolation between \pm RC, d-c output and alarm circuit. Refer to the RA 19-1U Manual for details. NOTE: POWER switch must be ON for remote control to be active.

CURRENT MONITOR. Current monitor (C and Y models only) is via \pm IMON assigned to pins of the RA 19-1U I/O connector: Monitored Output Current (Amps) = Voltage drop across R_s (Volts) / R_s (Ohms), where voltage drop across R_s (see Table 1) is measured across \pm IMON pins (requires millivoltmeter, range 0 to 200mV). Accuracy is $\pm 10\%$; contact Kepco if greater accuracy is required. There is no isolation between \pm IMON, alarm circuit and d-c output. Refer to the RA 19-1U Manual for details.

ALARM CIRCUIT. The HSF-1UR includes an isolated internal relay offering normally closed and normally open contacts referenced to an isolated common (see above for isolation restrictions for remote on-off or current monitor options. These contacts may be used to configure "close on failure" or "open on failure" alarm circuits ("close on failure" not available for X and Y models). (Refer to the RA 19-1U Manual for alarm configurations for multiple HSF-1UR power supplies.)

KEYING. Keying of the HSF-1UR is established at the factory (see Figure 3). The output voltage determines which key pins are installed. When the proper holes in the rack adapter are blocked by keying screws installed by the user, only a power supply of the correct voltage can be inserted in the rack adapter slot. (Refer to the RA 19-1U Manual for rack adapter keying instructions.)

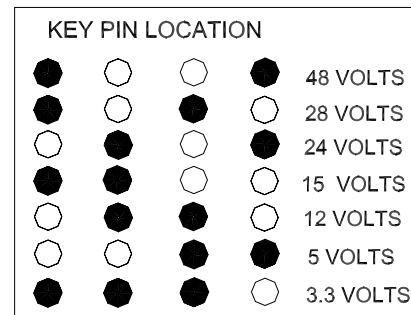

● = PIN PRESENT
○ = PIN MISSING

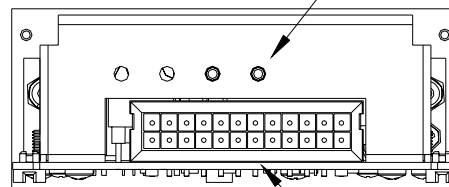

I/O CONNECTOR

SEE RA 19-1U RACK ADAPTER MANUAL FOR PIN ASSIGNMENTS.

3042636

FIGURE 3. REAR CONNECTOR AND KEYING

CONNECTIONS: The 24-pin I/O connector (Figure 3) is designed to mate with the corresponding connector in the RA 19-1U Rack Adapter.

(+) SENSE, (-) SENSE: These lines are provided to compensate for voltage drops in the load connecting wires. The Sense lines must be connected to their respective (+) and (-) output terminals, either at the load or at the rack adapter (see Rack Adapter Manual). The connection ensures the most accurate error tracking. Error compensation in the connecting wires is up to 0.25 Volts per lead for all models.

NOTE:

The Sense lines must be connected for the HSF-1UR Power supply to work properly!

OUTPUT (+), OUTPUT (-): HSF-1UR power supply d-c output.

CURRENT SHARE BUS (CSB): Connecting the CSB lines of HSF-1UR power supplies operating in a parallel configuration causes output current to be shared equally. (See Rack Adapter Manual for additional information on parallel configurations.) For current sharing to work properly the outputs of all paralleled units must be within 250 mV (max) of each other and each unit must be operating at between 10% to 100% of rated output. If current to the load goes below 10% for each unit in current share mode, all MASTER ON lights may go on (see load effect specifications); this indicates that forced current share is no longer working, units are simply in current share mode. (If forced current sharing at less than 10% nominal current per supply is needed, contact Kepco application engineering.) Remote sensing is recommended. For master/slave operation to work properly each unit should be adjusted to 40 mV (optimum) less than the next paralleled unit (unit 1 is adjusted to VOUT, unit 2 to VOUT - 40mV, and unit 3 to VOUT - 80mV, etc. If the master fails, the unit 2 will become the new master). The 40 mV difference can be reduced to a minimum of 25 mV as needed to parallel many units and still keep all units within 250 mV of each other. Adjust the outputs using Vadj trimmer on front panel.

- Optimum difference among output voltages of paralleled units: 40mV
- Maximum difference among output voltages of paralleled units: 250 mV

- Minimum difference among output voltages of paralleled units: 25 mV

NOTE: Current share requirements stated above may be extended to units located in adjacent racks.

ALARM: The Alarm NC (normally closed) - Open on Failure and Alarm NO (normally open) - Close on Failure lines are relay contacts referenced to Alarm Common. If the unit fails, the path between Alarm NC - Open on Failure and Alarm Common opens, the path between Alarm NO - Close on Fail and Alarm Common is a short circuit. Figure 4 illustrates typical Close on Fail and Open on Fail circuits to give a failure indication if any one of a number of power supplies fail.

INPUT POWER: Line (either a-c or d-c source power), Neutral and Ground (chassis)

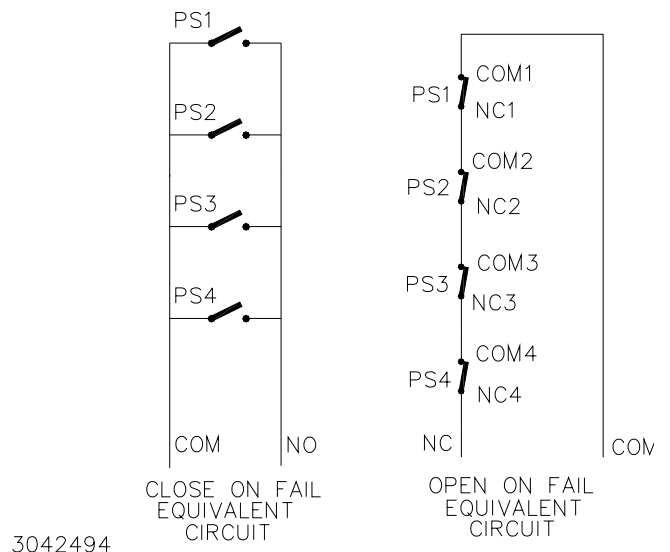

FIGURE 4. TYPICAL ALARM CIRCUIT DIAGRAMS

III — SPECIFICATIONS

The following specifications apply to all HSF-1UR 50 Watt Series models (also refer to Table 1) except where noted. Other models are also available; consult your Kepco representative for their specifications.

INPUT:

Voltage: 120V a-c/240V a-c nominal; Range 95-264V a-c; 125-370V d-c. (polarity insensitive; consult factory)

Frequency: Nominal 50-60 Hz; Range 47-440Hz (at 440Hz leakage current exceeds UL/VDE safety spec.limit).

Current (nominal output at rated load):

-1UR:

1.0A a-c typ., 1.2A a-c max (120V a-c rms input);
0.5A a-c typ., 0.7A a-c max. (240V a-c rms input)

Options T, C, X and Y, all except 3.3V model:
0.7A rms max. (100-120 Va-c input);
0.4A rms max. (200-240 Va-c input).

Options T, C, X and Y, 3.3V model:
0.6A rms max. (100-120 Va-c input);
0.3A rms max. (200-240 Va-c input).

Initial Turn-on Surge: (one-half of first input cycle):

@120V a-c rms, 45A max.,
@240V a-c rms, 90A max.

Brownout Voltage: 85V a-c, 110V d-c

Switching Frequency: 120KHz typical, nominal load

STABILIZATION:

Source Effect: Range 95-132V a-c or
190-265V a-c, 0.2% typ.; 0.3% max.

Load Effect: Range 10%-100% load, 0.5% typ.; 1.5% max.

Temperature Effect: Range 0° to 40°C, 0.5% typ.;
1.0% max.

Combined Effect: 0.9% typ.; 1.8% max. (includes
source, load, and temperature effects).

Time Effect: 0.2% typ.; 0.5% max. (1/2 hr-8 hr at
25°C).

RECOVERY CHARACTERISTICS: A step load change from 50% to 100% produces less than $\pm 4\%$ output excursion. Recovery occurs to within $\pm 1\%$ of the original setting in < 2 ms (load change t_r or t_f equal to or greater than 50 μ sec).

START-UP TIME: 500 ms. maximum.

HOLDUP TIME:

-1UR: 20 ms. typ. (120V a-c), 15 ms. min (100V a-c);
Options T, C, X and Y, all except 3.3V and 28V models:
30ms typ. (20ms min.);

Options T, C, X and Y, 3.3V model:
55ms typ., 40ms min.;

Options T, C, X and Y, 28V model:
35ms typ., 25ms min.

DIELECTRIC STRENGTH:

Between input and output: 2KV a-c (3KV a-c for
Options T, C, X and Y) for one minute.

Between input and output with Y-capacitor removed:
3.75KV a-c for one minute.

Between input and case (ground): 2KV a-c for one
minute.

INSULATION RESISTANCE: Between input and
ground, output and ground, input and output;
100 Megohms min. (500V d-c).

LEAKAGE CURRENT

-1UR Models:

UL method, 120V a-c: 0.5 mA maximum;
VDE method, 240V a-c: 0.75 mA maximum.

Options T, C, X and Y:

120V a-c and 60 Hz (in conformance with Den-An):
0.28mA typ, 0.45mA max;

240V d-c and 60 Hz (in conformance with IEC 950
and UL1950)0.38mA typ, 0.6mA max.

SAFETY: UL 60950-1, 1st Edition, 2007-10-31; CSA
C22.2 No. 60950-1-03, 1st Edition, 2006-07; EN 60950.
Units are CE marked per the Low Voltage Directive (LVD),
73/23/EEC and 93/68/EEC. [The standards do not apply
with DC input operation]

EMI: Designed to meet FCC Class B (100-120V a-c) and
VDE 0871 Class B (220-240V a-c).

VIBRATION: (non-operating, one hour on each one of
the three axes): 5-10 Hz, 10 mm amplitude, 10-55
Hz, 2g acceleration.

SHOCK: (non-operating, one-half sinusoidal pulse, three
shocks to each axis): Acceleration: 20g, Duration:
11ms \pm 5ms

OPERATING TEMPERATURE: See Figure 5.

STORAGE TEMPERATURE: -40°C to +75°C.

OPERATING AND STORAGE RELATIVE

HUMIDITY: up to 95% (wet bulb temp. $< 35^\circ\text{C}$ non-con-
densing).

FUSE: -1UR: Quick acting 3.0A, 250V; (5.2 x 20mm),
San-O P/N MT4 3A; Kepco P/N 541-0110.

T, C, X, Y Models: Wickmann P/N C1-372-2.0A,
Kepco P/N 541-0136.

DIMENSIONS: See Figure 7.

WEIGHT: -1UR Models: 1.5Lbs (0.7Kg);
T, C, X and Y Models: 1.25Lbs (0.57Kg).

WARRANTY: 5 years.

NOTE:
Safety agency approvals apply only to operation up to 40°C.

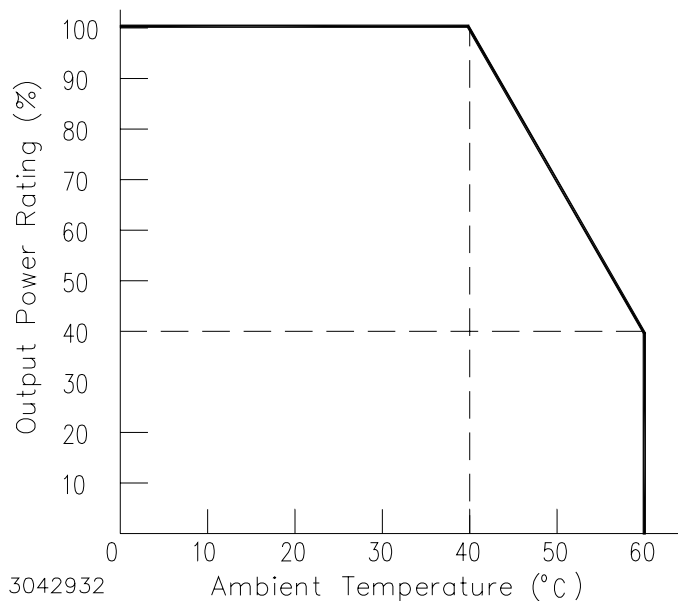

FIGURE 5. % OUTPUT POWER RATING VS. AMBIENT TEMPERATURE

IV — INSTALLATION

MOUNTING THE POWER SUPPLY. Refer to Figure 6 and insert HSF-1UR power supply in selected slot until power supply front panel is flush with rack adapter chassis and secure with two front panel mounting screws.

CAUTION: Do not overtighten these screws: max. torque is 2 in.-lbs. (0.23 N x m).

CONNECTIONS. All connections are made at the rear panel of the RA 19-1U Rack Adapter (see RA 19-1U Operator Manual). Connect the load to the applicable ± DC OUTPUT terminals. AC input power is applied via two INPUT POWER terminal blocks: one supplying slots 2 and 4, the other supplying slots 1 and 3. Make sure to

connect the AC input Neutral, Line and Ground wires to the respective terminals of the terminal blocks.

REMOVAL. To remove a power supply, first use the POWER switch to turn off the unit. Then loosen the two mounting screws and extract the unit from the RA 19-1U Rack Adapter. **CAUTION: The ON/OFF switch must be set to OFF before removing the unit from the rack adapter.**

V — OPERATION

Turn the unit on using the front panel POWER switch (see Figure 6). **CAUTION: DO NOT repeatedly toggle the POWER on/off switch as this may cause unit to fault.**

When output voltage is available, the VDC ON LED is on (green). All 50W models use convection cooling and do not include a fan.

While monitoring output voltage at the front panel test points, the Output Voltage Adjust trimmer allows adjustment of the output voltage.

The 3.3V models do not use forced current sharing so the MASTER ON LED is always off. The MASTER ON LED for 5V through 48V models goes on under any of the three following conditions:

- Independent operation.
- Operation in a parallel master/slave configuration to indicate which unit is the master.
- Operation in a parallel master/slave configuration to indicate that a slave unit is no longer within the proper specifications for paralleled units. Slave 1 should be optimally adjusted to 40mV less than master, slave 2 adjusted to 40mV less than slave 1, etc. The maximum allowable difference between paralleled units is 250mv. The minimum allowable difference between paralleled units is 25mV. If a slave exceeds these limits, the MASTER ON light goes on.

NOTE: MOUNTING SCREW MAX TORQUE: 2 IN.-LBS. (0.23 N x m)

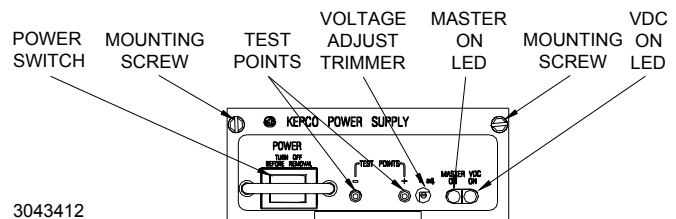
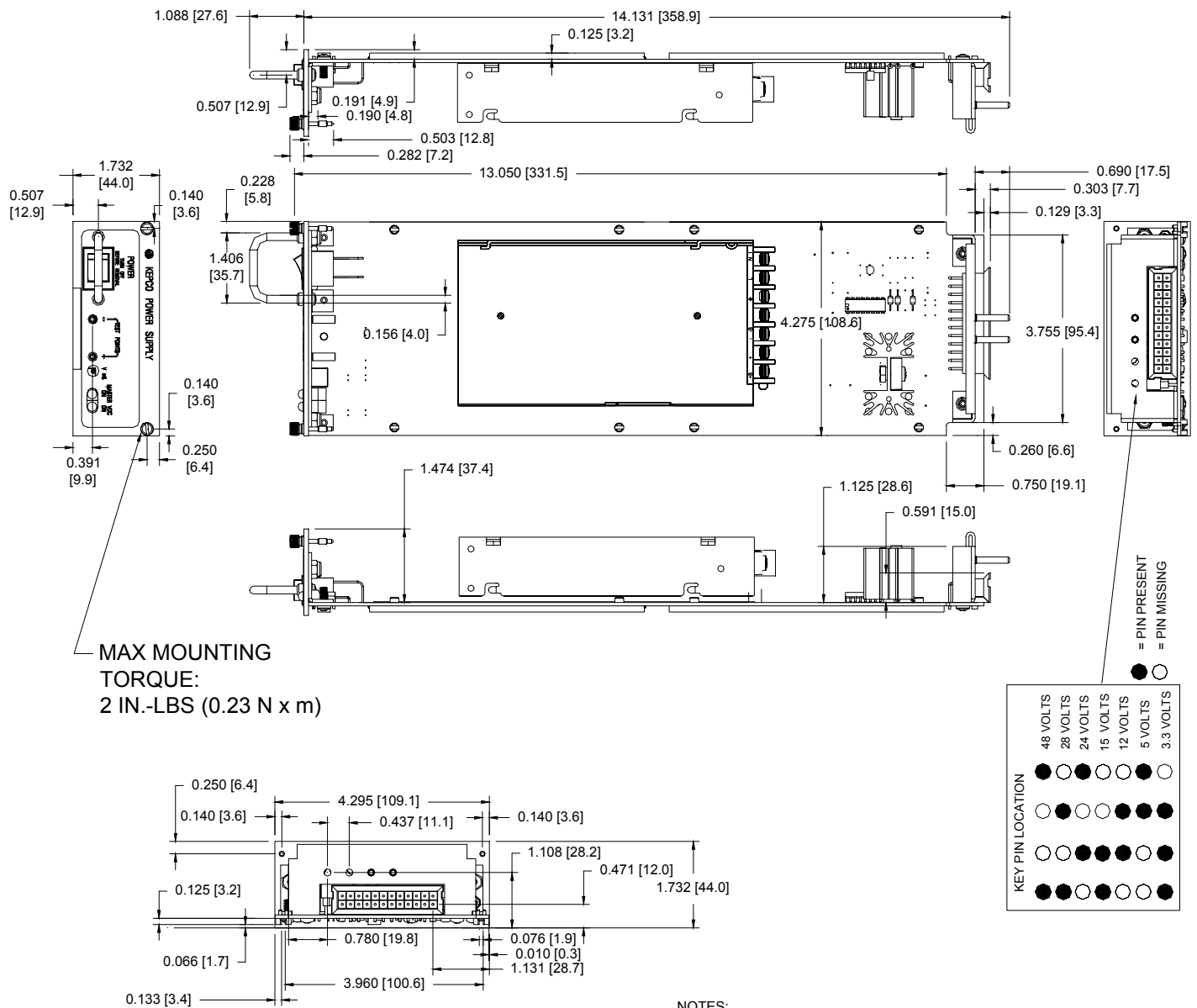

FIGURE 6. COMPONENT LOCATIONS



NOTES:

- MATERIAL:
 - BACKPLATE 0.064" THK. ALUM. 5052-H32
 - PCB 0.063" THK FR-4
 - FRONT PANEL 0.090 THK. ALUM. 6061-T6
- FINISH: FRONT PANEL -KEPCO DUAL TONE GRAY
- MODULE IS KEYPED AS SHOWN IN DETAIL
- DIMENSIONS ARE IN INCHES, [DIMENSIONS IN BRACKETS ARE IN MILLIMETERS].
- TOLERANCES (UNLESS OTHERWISE SPECIFIED):
 - 3 PLACES: ±0.005, 2 PLACES: ±0.01, FRACTIONS: ±1/64"

3043062

FIGURE 7. HSF-1UR 50W POWER SUPPLY OUTLINE DRAWING