

INSTRUCTION MANUAL

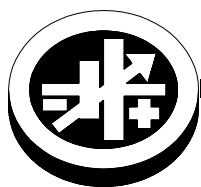

KEPCO An ISO 9001 Company.

HSF-1UR
100W SERIES



KEPCO SINGLE OUTPUT, 1U SIZE, 100 WATT HOT SWAP PLUG-IN POWER SUPPLIES

I – INTRODUCTION

The Kepco HSF-1UR 100 Watt Series hot swappable, high frequency switching, plug-in power supplies with built-in power factor correction (PFC) employ forward conversion and are designed to operate in a fault tolerant power system with either a-c or d-c input. A thermistor soft-start circuit limits start-up surge; an input fuse (3A, 250V) protects against shorts. Built-in OR-ing diodes (all models) and a forced current share circuit (all models except 3.3V) allow configuration of all models for hot-swap and parallel-redundant N+1 operation.

The heart of the HSF-1UR Series is a Kepco RTW power supply allowing them to weigh less and have improved efficiency (input current) specifications over the older HSF-1U Series. There are three options available: C, X and Y. Features for all models are the same except as follows: C option (-1URC) models include a current sensing resistor, allowing external current monitoring within $\pm 10\%$ (contact Kepco if greater accuracy required). X option (-1URX) models have remote control, the ability to turn the unit on and off from a remote location. Y option models (-1URY) include both current monitoring and remote on-off capabilities.

These power supplies are designed to be used with Kepco's Series RA 19-1U rack adapters. The RA 19-1U rack adapter accepts up to four 50-, 100- or 150-Watt units (see Figure 1). All input/output connections are through a 24-pin connector that plugs in to the rack adapter. All external connections are made through the rack adapter (refer to the RA 19-1U manual which is available for free download at:

www.kepcopower.com/support/opmanls.htm#ra19-1u

Seven models may be selected for outputs of 3.3, 5, 12, 15, 24, 28 or 48V (see Table 1).

When the input is cut off, the output is maintained for 20 milliseconds minimum. If the power supply shuts down due to an output overvoltage condition, it is then necessary to wait 60 seconds minimum before turning the unit on again. EMI filtering is designed to meet FCC Class B rating and VDE 0871 Class B rating. Table 1 contains specifications that vary for each model of the HSF-1UR 100 Watt Series. Specifications common to all models are listed on page 4.

TABLE 1. OUTPUT RATINGS AND SPECIFICATIONS, HSF-1UR 100W SERIES

MODEL	HSF 3.3-25-1UR (1) (2) (6)	HSF 5-20-1UR (1)	HSF 12-8.4-1UR (1)	HSF 15-6.7-1UR (1)	HSF 24-4.2-1UR (1)	HSF 28-3.5-1UR (1)	HSF 48-2-1UR (1)
OUTPUT VOLTS, d-c (NOMINAL)	3.3V	5V	12V	15V	24V	28V	48V
ADJUSTMENT RANGE	2.8 - 3.5V	4.3 - 5.3V	11.4 - 12.6V	13.5 - 16.5V	19.2 - 26.0V	26.5 - 29.5V	44.0 - 52.0V
OUTPUT CURRENT (NOMINAL) ⁽³⁾	25A ⁽³⁾	20A	8.4A	6.7A	4.2A	3.5A	2A
OUTPUT POWER (MAXIMUM) ⁽⁴⁾	82.5W	100W	100.8W	100.5W	100.8W	100.8W	100.8W
RIPPLE AND NOISE (mV p-p) 0-40°C, 10-100% LOAD	switching (typ)	80	80	100	100	150	200
	spike noise (d-c—50MHz)	120	120	150	150	200	300
OVERVOLTAGE SETTING (25°C, Nom. Input)	3.75 - 4.7V	5.6 - 6.4V	13.3 - 15.4V	16.8 - 18.8V	26.5 - 30.0V	29.7 - 34.7V	54.5 - 59.5V
OVERCURRENT SETTING (25°C, Nom. Input) Rectangular type characteristic	26.0 - 33.5A	20.7 - 24.8A	8.65 - 10.3A	6.8 - 8.9A	4.5 - 5.0A	3.6 - 4.7A	2.05 - 2.5A
Sense Resistor Value (milliohms) ⁽⁵⁾	5	5	10	20	20	30	50

(1) Unless otherwise noted, specifications are identical for all options.

(2) Forced current Share not available for 3.3V Models.

(3) Derates same as Output Power.

(4) See power rating curve, Figure 4. Exceeding maximum power rating may result in oscillation or a drop in output current or voltage..

(5) C and Y Models only (see "Current Monitor." on page 2 for details).

(6) Natural convection cooled; see Figure 5.

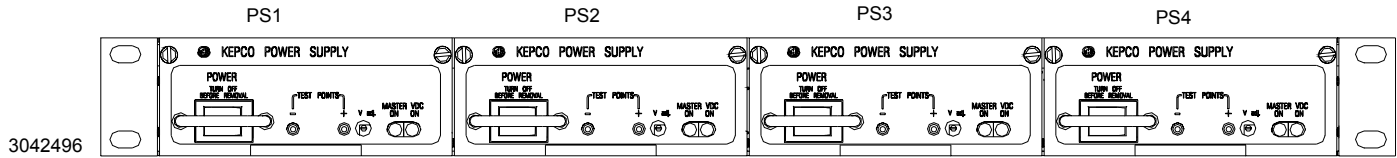

FIGURE 1. HSF-1UR 100 WATT POWER SUPPLIES (4) INSTALLED IN RA 19-1U RACK ADAPTER

II — FEATURES

FRONT PANEL ACCESS. The front panel provides a power ON/OFF switch controlling input power and a “VDC ON” light which indicates when the unit is operating. **NOTE: The ON/OFF switch must be set to OFF before removing unit from rack adapter.** The front panel “MASTER ON” LED lights when 1) the unit operates independently, or 2) the unit is used in parallel redundant configurations while a) the output is less than 10% of nominal or b) the output is within 10% to 100% of nominal and the unit is functioning as a master. In parallel redundant configurations, the module with the highest voltage functions as the master. The other units are slaves, and track the output voltage of the master. Refer to **Current Share Bus (CSB)** on page 3 for details. (For the 3.3V model, the “MASTER ON” LED has no function and is always off.) The front panel Vadj trimmer provides adjustment of the output voltage within the limits specified in Table 1; test points connected to the +S and –S lines are available at the front panel for measuring the output.

BUILT-IN OR-ING DIODES. OR-ing diodes allow configuration of all models for hot-swap and parallel-redundant N+1 operation where current distribution is not equal and the idle unit takes over in the event of failure.

FORCED CURRENT SHARE CIRCUIT. (Not available on 3.3V model). When units are configured for N+1 parallel redundant operation, it is desirable (but not required) for current to be divided equally among the paralleled supplies. When the CSB (forced Current Share Bus) lines of paralleled HSF-1UR units are connected together, the load current is forced to divide equally between all paralleled units; units operate at less than maximum, reducing stress and increasing reliability of the system. If one unit fails, the remaining units will continue to supply the load, and the load current will be divided equally among the remaining operating units. The failed unit is automatically isolated from the circuit by a built-in isolation diode. Refer to **Current Share Bus (CSB)** on page 3 for details.

REMOTE ON-OFF. Remote on-off (X and Y models only) is via ±RC assigned to pins of the RA 19-1U I/O connector: off = no voltage, short circuit, or 0 to 0.8V, on = 4.5 to 12.5V (or 12.5 to 24.5V via 1.5K Ohms). To reverse on-off polarity contact Kepco. There is no isolation between ±RC, d-c output and alarm circuit. Refer to the RA 19-1U Manual for details.

CURRENT MONITOR. Current monitor (C and Y models only) is via ±IMON assigned to pins of the RA 19-1U I/O connector: Monitored Output Current (Amps) = Voltage drop across Rs (Volts) / Rs (Ohms) (see Table 1), where voltage drop across Rs is measured across ± IMON pins (requires millivoltmeter, range 0 to 200mV). Accuracy is ±10%; contact Kepco if greater accuracy is required. There is no isolation between ±IMON, alarm circuit and d-c output. Refer to the RA 19-1U Manual for details.

ALARM CIRCUIT. The HSF-1UR includes an isolated internal relay offering normally closed and normally open contacts referenced to an isolated common. These contacts may be used to configure “close on failure” or “open on failure” alarm circuits. (Refer to the RA 19-1U Manual for alarm configurations for multiple HSF-1UR power supplies.)

KEYING. Keying of the HSF-1UR is established at the factory (see Figure 2). The output voltage determines which key pins are installed. When the proper holes in the rack adapter are blocked by keying screws installed by the user, only a power supply of the correct voltage can be inserted in the rack adapter slot. (Refer to the RA 19-1U Manual for rack adapter keying instructions.)

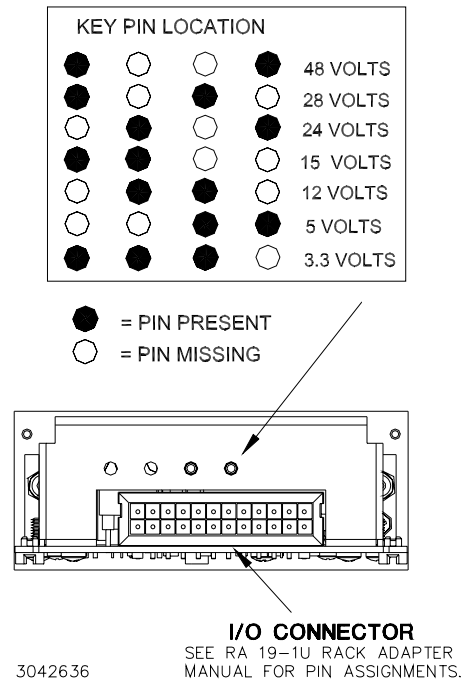

FIGURE 2. REAR CONNECTOR PIN ASSIGNMENTS

CONNECTIONS: The 24-pin I/O connector (Figure 2) mates with the corresponding connector in the RA 19-1U Rack Adapter. All external connections are made at the rack adapter (see Rack Adapter Manual).

(+) SENSE, (-) SENSE: These lines are provided to compensate for voltage drops in the load connecting wires. The Sense lines must be connected to their respective (+) and (-) output terminals, either at the load or at the rack adapter (see Rack Adapter Manual). The connection ensures the most accurate error tracking.

NOTE:

The Sense lines must be connected for the HSF-1UR Power supply to work properly!

Compensation per lead = (min. overvoltage - max.adjustment range)/2; refer to Table 1. Compensation for 3.3V Model is 0.1V per lead. Higher compensation values are possible if output voltage is decreased below the maximum adjustment range shown in Table 1. Load wire length should not be more than 16.4ft. (5m). Transient recovery specs may not be met when remote sensing is used. To prevent oscillations and premature tripping of overvoltage protection, install one electrolytic (not tantalum) capacitor (470mF min) between +S and +V and one between ±S terminals.

OUTPUT (+), OUTPUT (-): HSF-1UR power supply d-c output.

INPUT POWER: Line (either a-c or d-c source power) , Neutral and Ground (chassis)

CURRENT SHARE BUS (CSB): (Not available on 3.3V models.) Connecting the CSB lines of HSF-1UR power supplies operating in a parallel configuration causes output current to be shared equally. (See Rack Adapter Manual for additional information on parallel configurations.). For current sharing to work properly the outputs of all paralleled units must be within 250 mV (max) of each other and each unit must be operating at between 10% to 100% of rated output. If current to the load goes below 10% for each unit in current share mode, all MASTER ON lights may go on (see load effect specifications); this indicates that forced current share is no longer working, units are simply in current share mode. (If forced current sharing at less than 10% nominal current per supply is needed, contact Kepco application engineering.) Remote sensing is recommended. For master/slave operation to work properly each unit should be adjusted to 40 mV (optimum) less than the next paralleled unit (unit 1 is adjusted to VOUT, unit 2 to VOUT – 40mV, and unit 3 to VOUT – 80mV, etc. If the master fails, unit 2 will become the new master). The 40 mV difference can be reduced to a minimum of 25 mV as needed to parallel many units and still keep all units within 250 mV of each other. Adjust the outputs using Vadj trimmer on front panel.

- Optimum difference among output voltages of paralleled units: 40mV

- Maximum difference among output voltages of paralleled units: 250 mV
- Minimum difference among output voltages of paralleled units: 25 mV

NOTE: Current share requirements stated above may be extended to units located in adjacent racks.

ALARM: The Alarm NC (normally closed) - Open on Failure and Alarm NO (normally open) - Close on Failure lines are relay contacts referenced to Alarm Common. If the unit fails, the path between Alarm NC - Open on Failure and Alarm Common opens, the path between Alarm NO - Close on Fail and Alarm Common is a short circuit. Figure 3 illustrates typical Close on Fail and Open on Fail circuits to give a failure indication if any one of a number of power supplies fail; refer to RA 19-1U manual for complete information regarding other configurations.

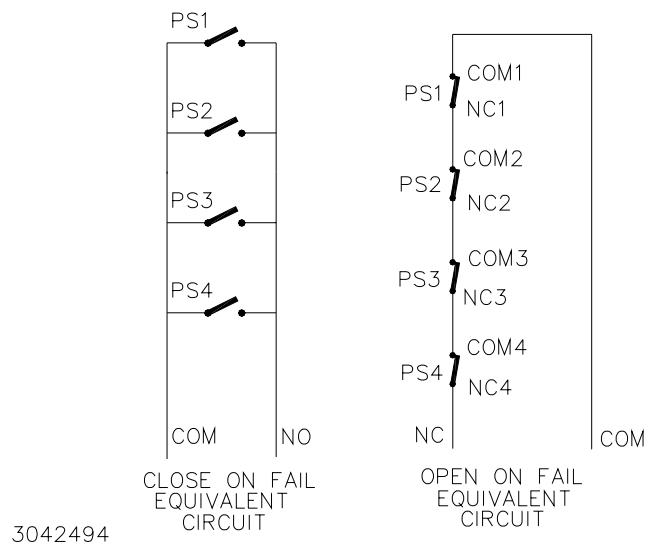

FIGURE 3. TYPICAL ALARM CIRCUIT DIAGRAMS

Units are shipped so that the alarm will trip and shutdown will occur upon overvoltage, open sense line and fan failure (fan failure shutdown can be disabled, see “Cooling:” on page 4 and Figure 7). The alarm will also trip upon undervoltage, however shutdown may not occur, depending on the load. After shutdown occurs, a 60 second delay (minimum) is required before turning the unit on again.

Forced shutdown upon fan failure (not applicable to 3.3V Model) can be disabled by installing a jumper, Kepco P/N 172-0382 (Digikey P/N A26231-N) as shown in Figure 7. This allows the unit to continue to operate with the fan inoperative (see Figure 4 for safe operating conditions); the alarm signals noted above will report an alarm condition, and the VDC ON indicator will either light red (fan supply voltage missing) or flicker between red and green (mechanical failure). If the jumper is installed, the user is responsible for either reducing the load to within the specifications given in Figure 4, or shutting down the unit using the alarm signals provided.

III — SPECIFICATIONS

The following specifications apply to HSF-1UR 100 Watt Series models (also refer to Table 1). Other models are also available; consult your Kepco representative for their specifications.

INPUT:

Voltage: 100-120V a-c, 200-240V a-c nominal;
Range 95-264V a-c; d-c range: 125-370V d-c.

Frequency: Nominal 50-60 Hz; Range 47-440Hz
(from 66 to 440Hz leakage current exceeds UL/
VDE safety spec. limit).

Current (nominal output at 100% load):

@100-120V a-c rms: 1.5A rms max;

@200 - 240V a-c: 0.75A rms max

3.3V Model:

@100 - 120V a-c: 1.1A rms max;

@200 - 240V a-c: 0.55A rms max.

Initial Turn-on Surge: (cold start 25 °C, first surge
only, not including the current flow into the EMI fil-
ter):

@100V a-c rms, 14A typ.,

@200V a-c rms, 28A typ.

Brownout Voltage: 85V a-c, 110V d-c

Switching Frequency: 135KHz typical, PFC boost
converter: 80KHz typical, nominal load

STABILIZATION:

Source Effect:

95-132V a-c or 190-265V a-c:

0.3% typ.; 0.6% max.

3.3V Model 5mV typ., 10mV max.

Load Effect:

12V-48V models: 0.5% typ.; 1.2% max.,

3.3V, 5V models: 1.5% typ.; 2% max.

Temperature Effect, Range -10° to 50°C:

0.5% typ.; 1.0% max.

Combined Effect (source, load, temperature):

0.9% typ., 1.8% max.

Time Effect (drift): (1/2 to 8 hr. at 25°C)

0.2% typ., 0.5% max.

RECOVERY CHARACTERISTICS: A step load
change from 50% to 100% produces less than $\pm 4\%$ output
excursion. Recovery occurs to within $\pm 1\%$ of the original
setting in < 2 ms (load change t_r or t_f equal to or greater
than 50 μ sec).

START-UP TIME:

400 ms. typ., 500 ms. max. (100V a-c),

200 ms. typ., 300 ms. max. (240V a-c),

ACCEPTABLE LOAD CAPACITANCE: (Start-up
time is affected.)

10,000 μ F max.

HOLDUP TIME: 35 ms. typ., 20 ms. min.

DIELECTRIC STRENGTH: (at 15 to 35°C ambient,
10 to 85% relative humidity):

Between input and output: 3KV a-c for one minute,
cutout current 10ma..

Between input and ground: 2KV a-c for one minute,
cutout current 10ma.

Between output and ground: 500V a-c for one min-
ute, cutout current 20ma.

INSULATION RESISTANCE: Between input and
ground, output and ground, input and output, \pm RC ter-
minals and input, \pm RC terminals and output: 100
Megohms min. (500V d-c).

LEAKAGE CURRENT:

0.13mA typ, 0.19mA max at 120V a-c and 60 Hz
(operating in conformance with Den-An).

0.30mA typ, 0.45mA max at 240V d-c and 60 Hz
(operating in conformance with IEC 950 and
UL1950).

SAFETY: EN 60950:2001 Assistance for DEN-AN. U.S.
UL 60950 First Edition.; Canada: CSA-22.2 No. 60950-1.
Units are CE marked per the Low Voltage Directive (LVD),
EN60950 73/23/EEC AND 93/68/EEC. [The standards do
not apply with DC input operation.]

COOLING: Natural convection for 3.3V model; 5-48V
models use forced convection, ball-bearing fans, life
expectancy 50,000+ hours. Natural convection can be
used for 5-48V models if the load does not exceed the lim-
its specified in Figure 4). Simply disconnect the fan and
install jumper J1 (see Figure 7); the alarm signals
described above are disabled and VDC ON lights red;
overvoltage and open sense line conditions still force unit
shutdown. Contact Kepco's Application Engineering for
full-featured natural convection-cooled units.

EMI: Designed to meet FCC Class B (100-120V a-c)
and VDE 0871 Class B (220-240V a-c).

VIBRATION: (non-operating, one hour on each one of
the three axes):

5-10 Hz, 10 mm amplitude;

10-55 Hz, 2g acceleration.

SHOCK: (non-operating, one-half sinusoidal pulse, three shocks to each axis):
 Acceleration: 20g,
 Duration: 11ms \pm 5ms

OPERATING TEMPERATURE: See Figure 4.

STORAGE TEMPERATURE: -40°C to +75°C.

RELATIVE HUMIDITY: Operating and storage: 10% to 95% (wet bulb temp. <35°C non-condensing).

FUSE: Quick acting 5.0A, 250V; (5.2 x 20mm),
 Littelfuse P/N 215005PF,
 Kepco P/N 541-0134.

DIMENSIONS: See Figure 5.

WEIGHT: 1.7 lbs, 0.75Kg.

WARRANTY: 5 years.

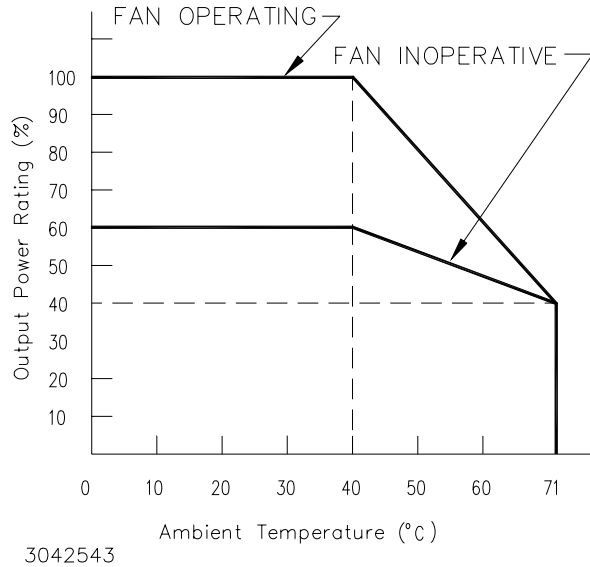

NOTE:
 Safety agency approvals
 apply only to operation
 up to 40°C.

FIGURE 4. % OUTPUT POWER RATING VS. AMBIENT TEMPERATURE, 5V THROUGH 48V MODELS

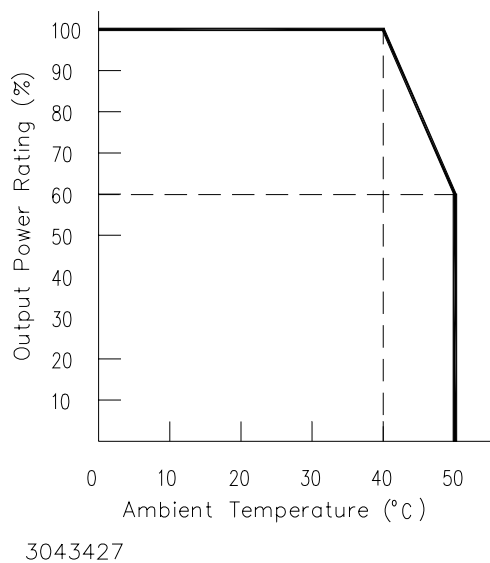

NOTE:
 Safety agency approvals
 apply only to operation
 up to 40°C.

FIGURE 5. % OUTPUT POWER RATING VS. AMBIENT TEMPERATURE, 3.3V MODEL

IV — INSTALLATION

MOUNTING THE POWER SUPPLY. Refer to Figure 6 and insert HSF-1UR power supply in selected slot until power supply front panel is flush with rack adapter chassis and secure with two front panel mounting screws.

CAUTION: Do not overtighten these screws: max. torque is 2 in.-lbs (0.23 N x m).

CONNECTIONS. All connections are made at the rear panel of the RA 19-1U Rack Adapter (see RA 19-1U Operator Manual). Connect the load to the applicable \pm DC OUTPUT terminals. AC input power is applied via two

INPUT POWER terminal blocks: one supplying slots 2 and 4, the other supplying slots 1 and 3. Make sure to connect the AC input Neutral, Line and Ground wires to the respective terminals of the terminal blocks.

REMOVAL. To remove a power supply, first use the POWER switch to turn off the unit. Then loosen the two mounting screws and extract the unit from the RA 19-1U Rack Adapter. **CAUTION: The ON/OFF switch must be set to OFF before removing the unit from the rack adapter.**

V — OPERATION

Turn the unit on using the front panel POWER switch (see Figure 6). **CAUTION: DO NOT repeatedly toggle the POWER on/off switch as this may cause unit to fault.**

When output voltage is available, the VDC ON LED is on (green). For 100W and 150W 5V through 48V models the VDC ON LED lights red to indicate a fan malfunction. The 100W 3.3V model and all 50W models use convection cooling and do not include a fan.

While monitoring output voltage at the front panel test points, the Output Voltage Adjust trimmer allows adjustment of the output voltage.

The 3.3V models do not use forced current sharing so the MASTER ON LED is always off. The MASTER ON LED for 5V through 48V models goes on under any of the three following conditions:

- Independent operation.
- Operation in a parallel master/slave configuration to indicate which unit is the master.

NOTE: MOUNTING SCREW MAX TORQUE: 2 IN.-LBS. (0.23 N x m)

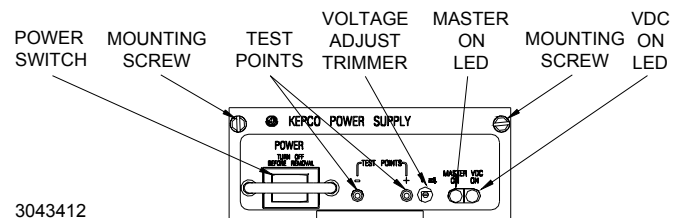

3043412

FIGURE 6. COMPONENT LOCATIONS

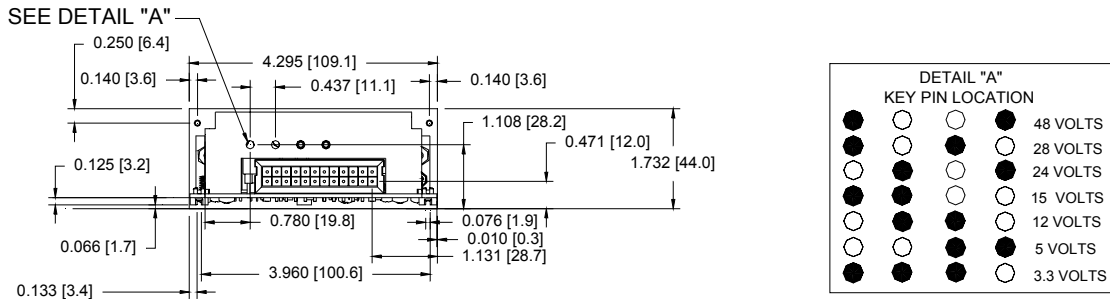
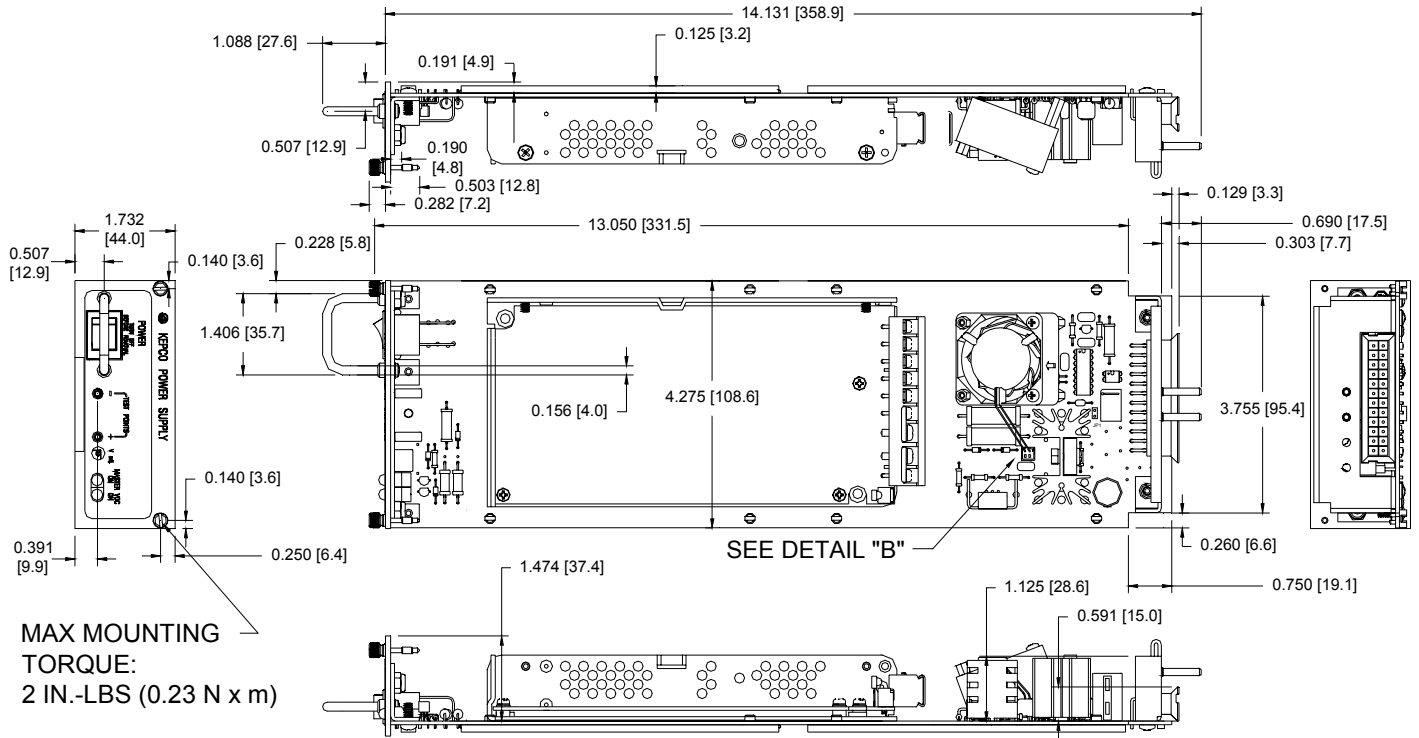

NOTES:

- MATERIAL:
 - BACKPLATE 0.064" THK. ALUM. 5052-H32
 - PCB 0.063" THK FR-4
 - FRONT PANEL 0.090 THK. ALUM. 6061-T6
- FINISH: FRONT PANEL -KEPCO DUAL TONE GRAY
- MODULE IS KEYED AS SHOWN IN DETAIL
- DIMENSIONS ARE IN INCHES, [DIMENSIONS IN BRACKETS ARE IN MILLIMETERS].
- TOLERANCES (UNLESS OTHERWISE SPECIFIED):
3 PLACES: ±0.005, 2 PLACES: ±0.01, FRACTIONS: ±1/64"
- TO DISABLE FORCED SHUTDOWN UPON FAN FAILURE, INSERT JUMPER (P/N 172-0382) AS SHOWN IN DETAIL "B."
- FOR CONVECTION COOLING, DISCONNECT FAN AND INSERT JUMPER (P/N 172-0382) AS SHOWN IN DETAIL "B."

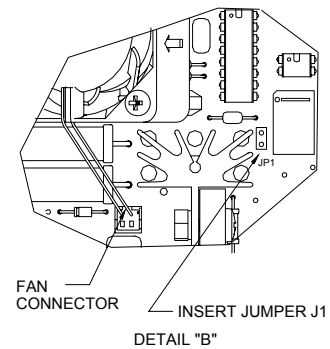

3010294

FIGURE 7. HSF-1UR 100W POWER SUPPLY OUTLINE DRAWING