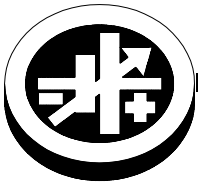


# QUICK START GUIDE



**KEPCO** An ISO 9001 Company.

**BOP  
1KW-MG** 

## BOP 1KW-MG POWER SUPPLY

This guide gives a brief introduction to the BOP 1KW-MG Power supply, shows simple load connections, and allows you to verify the power supply is working. The guide also shows you how to use the front panel controls to perform the most commonly used functions.

**ACCESSING MANUALS.** First determine your Firmware Version (see below), then download the BOP 1KW-MG applicable Operator's Manual from [www.kepcopower.com/support/opmanls.htm#bop-1k](http://www.kepcopower.com/support/opmanls.htm#bop-1k). Refer to the BOP 1KW-MG Operator's Manual for full specifications, installation considerations and operating instructions, including, an Installation/Operation Sum-

mary which includes hyperlinked references to detailed procedures, but which can be printed as a handy reference. The BOP 1KW-MG Operator's Manual also includes a full description of the digital interfaces and the SCPI command language.

**FIRMWARE VERSION.** Refer to [www.kepcopower.com/support/bophifirm.htm](http://www.kepcopower.com/support/bophifirm.htm) to determine which firmware version is installed.

**ACCESSING DRIVERS.** Drivers are accessed from [www.kepcopower.com/drivers/drivers-dl3.htm](http://www.kepcopower.com/drivers/drivers-dl3.htm).

## CONTENTS

Description	2
Unpacking	2
Equipment Supplied	2
Accessories	4
Safety	4
Preliminary Operational Check	5
Installation	5
Input Connections	5
Load Connections	5
Local Sensing (Factory Default)	5
Remote Sensing Select	5
Analog I/O Connections	5
Trigger Connections	5
GPIB Connections	5
RS 232 Connections	6
Operation	8
Turning The Power Supply On	8
Accessing the Menus	8
How to Modify a Parameter	9
Adjusting LCD Brightness, contrast and Background	10
Enabling/Disabling Audible Beeps	10
Setting Voltage or Current Mode	10
Programming Voltage or Current and Associated Protect Limits	10
Software Limits	11
Changing Main Channel Software limit	11
Determining How the Unit Responds when Output is OFF (Load Type)	12
Configure Load Type	13
Enabling/disabling Output Power	13
Additional Features	13
BOP 1KW Outline Dimensions	14

## I — DESCRIPTION.

The BOP 1KW-MG Series hereafter referred to as BOP, are true 4-quadrant programmable voltage and current power supplies, meaning they are capable of both sourcing and sinking power (see Figure 1). These bipolar power supplies pass smoothly through zero without switching to provide true  $\pm$  voltage and  $\pm$  current. These BOP power supplies use switch mode technology for low dissipation. A bi-directional, isolating, a-c input power factor correcting (PFC) circuit recuperates energy sunked from an active load and sends it back into the line to maintain low dissipation.

These BOP power supplies are controlled digitally from a menu-driven front-panel keypad or one of the standard remote digital interfaces (GPIB or RS 232) to set voltage and current and the four protection

limits (+voltage, -voltage, +current and -current.) A front panel rotary adjuster allows real-time adjustment of the output. A large LCD displays the mode of operation, the settings, and the actual output voltage and current. Additionally, these BOP models can be remotely controlled by an analog  $\pm 10V$  input for the main channel (voltage or current), and a +1 to +10V input for the limit channels.

BOP models are suitable for driving inductive loads such as large magnets or motors, and for exercising batteries. They are also suitable for characterizing solar cell arrays, and powering many electrochemical reactions.

**TABLE 1. BOP 1KW-MG MODEL PARAMETERS**

Model	d-c Output Range		Closed Loop Gain		Output Impedance			
	Voltage (V d-c)	Current (A d-c)	Voltage Channel $G_V$ (V/V)	Current Channel $G_I$ (A/V)	Voltage Mode (Series R - L)		Current Mode (Parallel R - C)	
					$R_{d-c}$ (mOhms)	L ( $\mu$ H)	$R_{d-c}$ (Ohms)	C ( $\mu$ F)
1000 WATT MODELS								
BOP 6-125MG	0 to $\pm 6$	0 to $\pm 125$	0.6	12.5	0.05	1.5	24	1150
BOP 10-75MG	0 to $\pm 10$	0 to $\pm 75$	1.0	7.5	0.13	2.0	67	976
BOP 20-50MG	0 to $\pm 20$	0 to $\pm 50$	2.0	5.0	0.40	8.3	200	371
BOP 25-40MG	0 to $\pm 25$	0 to $\pm 40$	2.5	4.0	0.63	15.8	313	165
BOP 36-28MG	0 to $\pm 36$	0 to $\pm 28$	3.6	2.8	1.30	25	640	103
BOP 50-20MG	0 to $\pm 50$	0 to $\pm 20$	5.0	2.0	2.50	50	1250	55
BOP 72-14MG	0 to $\pm 72$	0 to $\pm 14$	7.2	1.4	5.14	104	2570	33
BOP 100-10MG	0 to $\pm 100$	0 to $\pm 10$	10.0	1.0	10.0	163	5000	16
NOTE: When connecting active loads, the steady-state voltage of the active load must not exceed the maximum voltage rating of the BOP. Otherwise the overvoltage protection will shut down the power supply.								

## II — UNPACKING.

This instrument has been thoroughly inspected and tested prior to packing and is ready for operation. After careful unpacking, inspect for shipping damage before attempting to operate. Perform the "Preliminary Operational Check." on page 5. If any indication

of damage is found, file an immediate claim with the responsible transport service.

## III — EQUIPMENT SUPPLIED.

See Table 2.

**TABLE 2. EQUIPMENT SUPPLIED**

ITEM	FUNCTION	PART NUMBER
Source Power Entry mating connector	Mates with source power entry connector	142-0381 (Kepeco) (IEC 320)
PAR/SER CONTROL - IN mating connector	Mates with PAR/SER CONTROL - IN port to allow access to pins required for calibration	142-0488 (Kepeco)

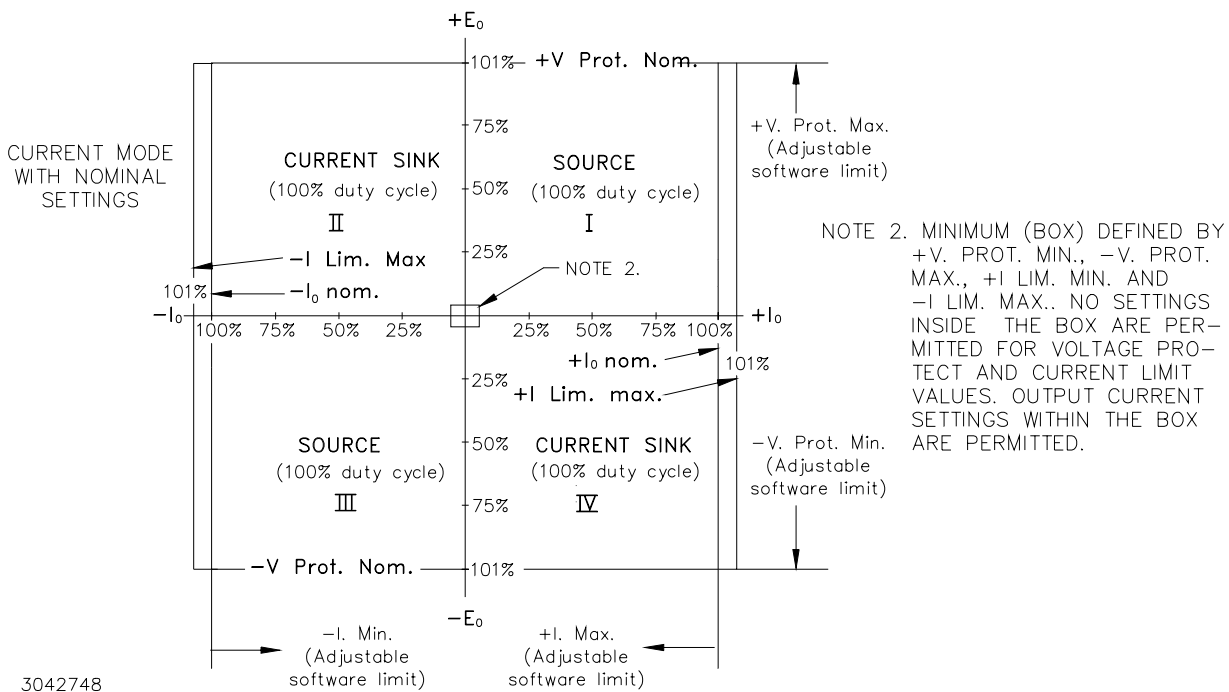
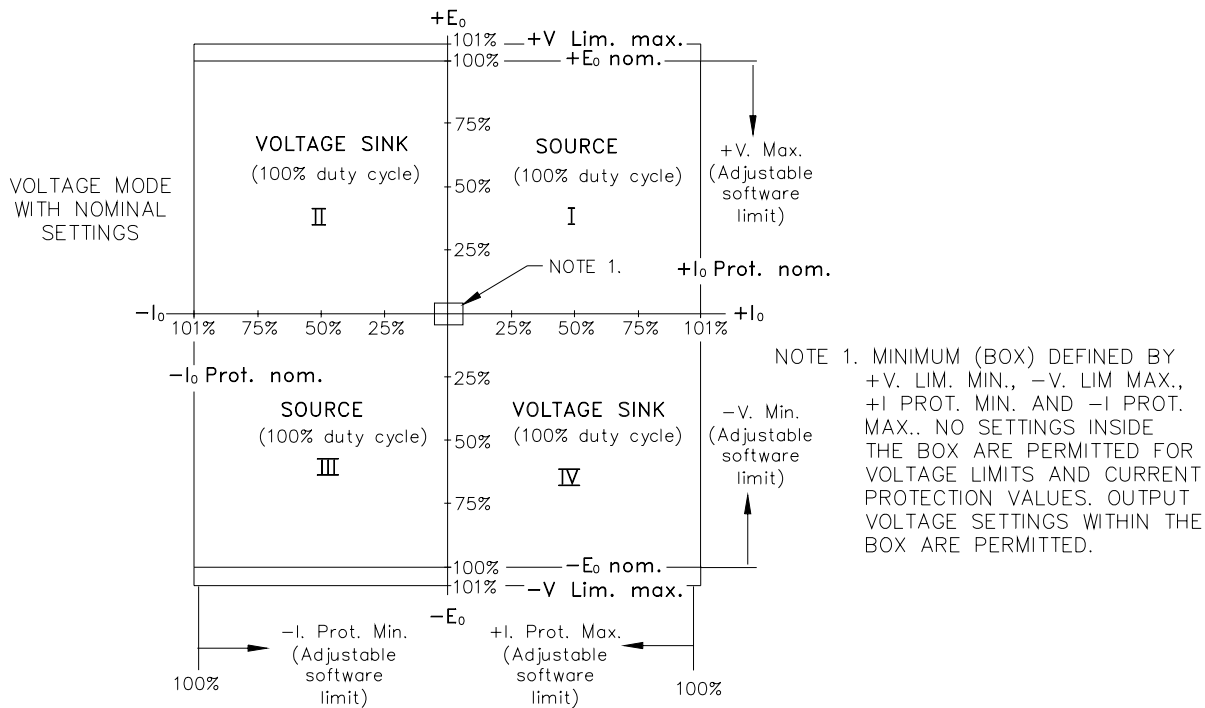


FIGURE 1. BOP OUTPUT CHARACTERISTICS



**IV — ACCESSORIES.** See Table 3.

**TABLE 3. ACCESSORIES**

ITEM	FUNCTION	PART NUMBER
Line Cord (250V, 20A)	Provides connection to a-c mains via Nema 6-20P connector.	118-1087
Line Cord (250V, 20A)	Provides connection to a-c mains via Nema L6-20P locking type connector.	118-1088
Mating Connector, Trigger	Mates with Trigger port.	142-0527 (Kepco) SP2501 (CUI Stack)
IEEE 1118 (BITBUS) Mating connector	Allows connection to IEEE 1118 (BITBUS) port.	142-0485 (Kepco) KMDLA-5P (Kycon Inc.)
IEEE 488 Cable, (1 meter long)	Connects BOP power supply to GPIB bus.	SNC 488-1
IEEE 488 Cable, (2 meter long)	Connects BOP power supply to GPIB bus.	SNC 488-2
IEEE 488 Cable, (4 meter long)	Connects BOP power supply to GPIB bus.	SNC 488-4
Interconnection Kits for parallel/series configurations.	Cables required to connect multiple BOP models in parallel, series, or parallel/series configurations.	See Operator's Manual.
RS 232 Cable Kit	Contains RJ11 to RJ45 Patch cord, RJ 45 Patch cord, two RS 232 adapters, one with male pins to connect to DTE equipment and one with female pins to connect to a PC (personal computer), two RS 232 Loop Back test Connectors (one 6-pin and one 8-pin) to test RS 232 communication and aid in isolating RS 232 communication problems.	KIT 219-0436
RS 232 Adapter (Male pins)	Allows RS 232 port to be connected to DTE equipment. (Supplied in KIT 219-0436.)	142-0487 (L-COM RA098M)
RS 232 Adapter (Female pins)	Allows RS 232 port to be connected to a PC (personal computer). (Supplied in KIT 219-0436.)	142-0506 (L-COM RA098F)
15-pin DSUB Connector	Mating connector for Analog input connector A2A5J6 Dsub 15 pin hood Dsub 15 pin male	108-0374 (Tyco-Amp 207470-1) 142-0449 (Amphenol 17S-DA15P)
IDC 6-pin connector	Mating connector for RS-232 PORT, connector A1J5 and PROTECTION EXT. PORT, connector A2A5J7	142-0536 (Amphenol 5-555176-3)
IDC 8-pin plug	Mating connector for PAR/SER PROTECT PORT (IN and OUT) connectors.	142-0535 (Amphenol 5-555176-3)
Slides	Allows easy withdrawal of unit from rack (see Figure 1). (Model CS 04 includes slides, brackets, all mounting hardware and installation instructions.)	CS 04
Heat Sink	Provides adequate cooling for calibration sense resistors.	136-0451

**V — SAFETY.** See Table 4

**TABLE 4. SAFETY SYMBOLS**

SYMBOL	MEANING
	CAUTION: RISK OF ELECTRIC SHOCK.
	CAUTION: REFER TO REFERENCED PROCEDURE.
WARNING	INDICATES THE POSSIBILITY OF BODILY INJURY OR DEATH.
CAUTION	INDICATES THE POSSIBILITY OF EQUIPMENT DAMAGE.

## VI — PRELIMINARY OPERATIONAL CHECK.

A simple operational check after unpacking and before equipment installation is advisable to ascertain whether the power supply has suffered damage resulting from shipping.

1. With POWER switch set to off position, connect the power supply to source power (see "Input Connections." on page 5).
2. With no load connected, set POWER switch to the ON position. Each time the unit is turned on an internal self-test is performed. If all tests pass, the unit goes into the default mode. If a failure occurs, the failure is displayed. Figure 5 shows

the factory-configured power on defaults displayed on the LCD.

3. Connect a digital voltmeter (DVM) (resolution and accuracy of 0.01% or better) to the OUT S and COM S terminals at the rear panel terminal block.
4. Use the keypad to enter the rated maximum voltage of the power supply (e.g., enter 36 for a model BOP 36-28MG) and press **ENTER**. If STANDBY indicator is lit, press **STANDBY** key.
5. Verify DVM voltage reading agrees with programmed voltage within 0.03% of rated maximum voltage and agrees with displayed voltage on LCD within 0.05% of rated maximum voltage.

## VII — INSTALLATION.

Install units either on a bench or in a 19 inch-wide rack. For rack mounting: remove four feet first; rack must provide support at the rear). Optional slides may be used. Leave the front and rear panels clear of obstructions to ensure adequate cooling. For parallel, series and master-slave configurations, refer to the Operator's Manual.

**INPUT CONNECTIONS.** Source power is connected to the power supply via three-wire input power using the source power mating connector supplied (see Table 3). This power supply operates from single phase a-c mains power (or between two phases of 3-phase a-c mains power), 230V, 50/60Hz nominal (range: 176 - 264V, 47-63Hz) without any need for range selection. The user must provide a properly sized and rated mains lead (line cord) and service with a current rating compatible with the anticipated input current. Line cords available as accessories are listed in Table 3. Plug the source power connector into the source power inlet connector at the rear panel.

**LOAD CONNECTIONS.** Power connections require wires that are properly rated for the nominal output current of the unit. Connect the load to the OUTPUT and COMMON power terminals on the rear panel (see Figure 3). OUT S and COM S terminal of the Monitor and Sensing Terminal block are for connection of remote sensing leads (after removing the factory-installed local sensing links). **NOTE: Output Sense lines must be connected for proper operation, either locally, or at the load (remote).** Also use OUT S and COM S to monitor voltage at the load using external equipment such as a DVM, oscilloscope, etc. Use OUT MON and COM MON to monitor voltage at the BOP output.

### LOCAL SENSING (FACTORY DEFAULT).

Unit is shipped with local sensing links installed: OUT S connected to OUT MON and COM MON connected to COM S (see Figure 4A).

**REMOTE SENSING SELECT.** First remove the factory-installed local sensing links between OUT S and OUT MON and between COM MON and COM S. Then connect the OUT S and COM S lines at the load (see Figure 4B) using #22 AWG wire, twisted pair.

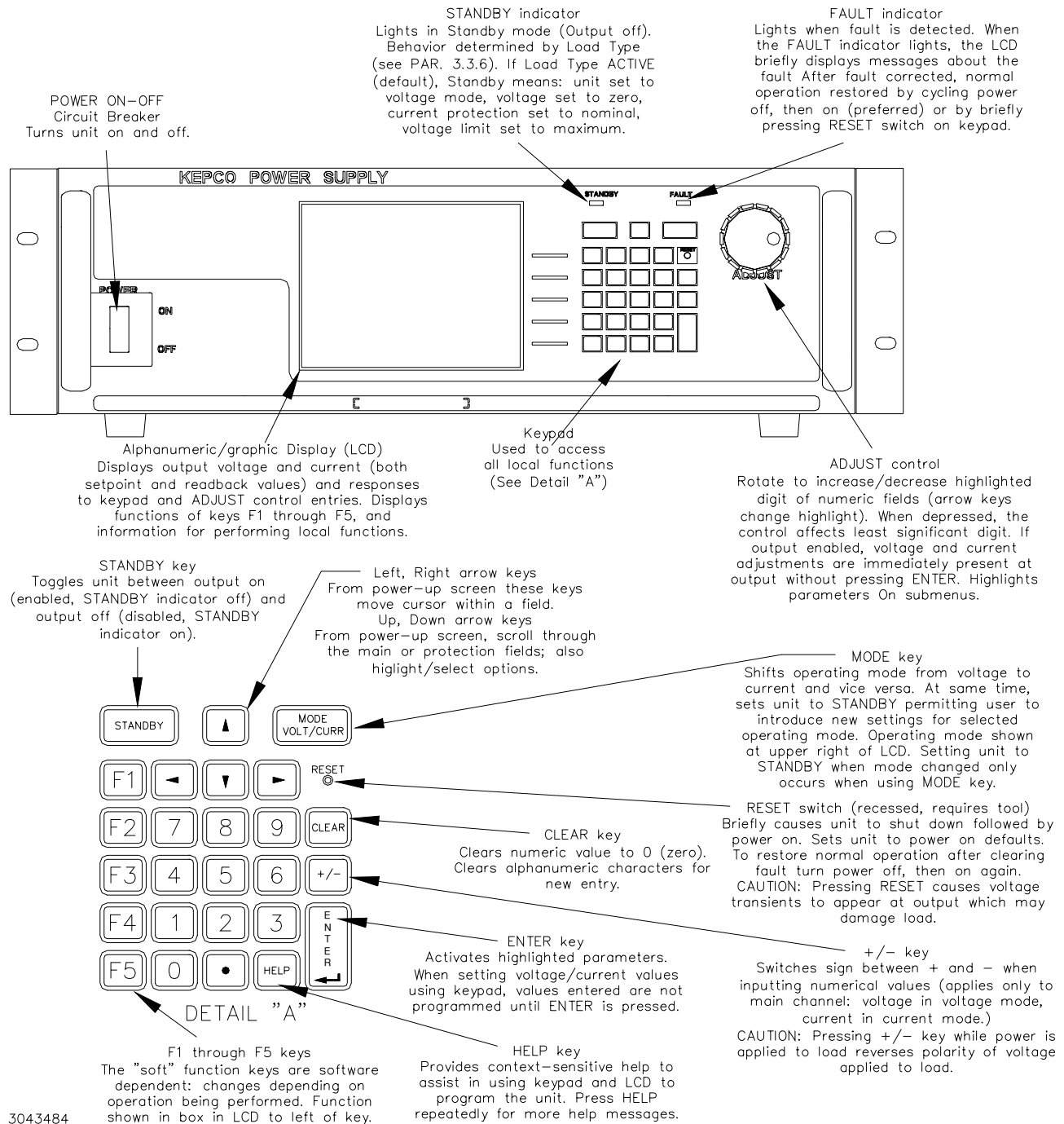
**ANALOG I/O CONNECTIONS.** The Analog I/O Port connector, located on the rear panel of the BOP 1KW power supply (see Figure 3), provides access to analog programming inputs which can control the mode of operation (voltage or current), output voltage or current, and establish positive and negative voltage and current limits. An output analog corresponding to output current is also provided. Refer to Operator's manual for details.

**TRIGGER CONNECTIONS.** The Trigger Port (see Figure 3) provides for an external trigger input for use with SCPI \*TRG and TRIG commands. Refer to Operator's manual for details.

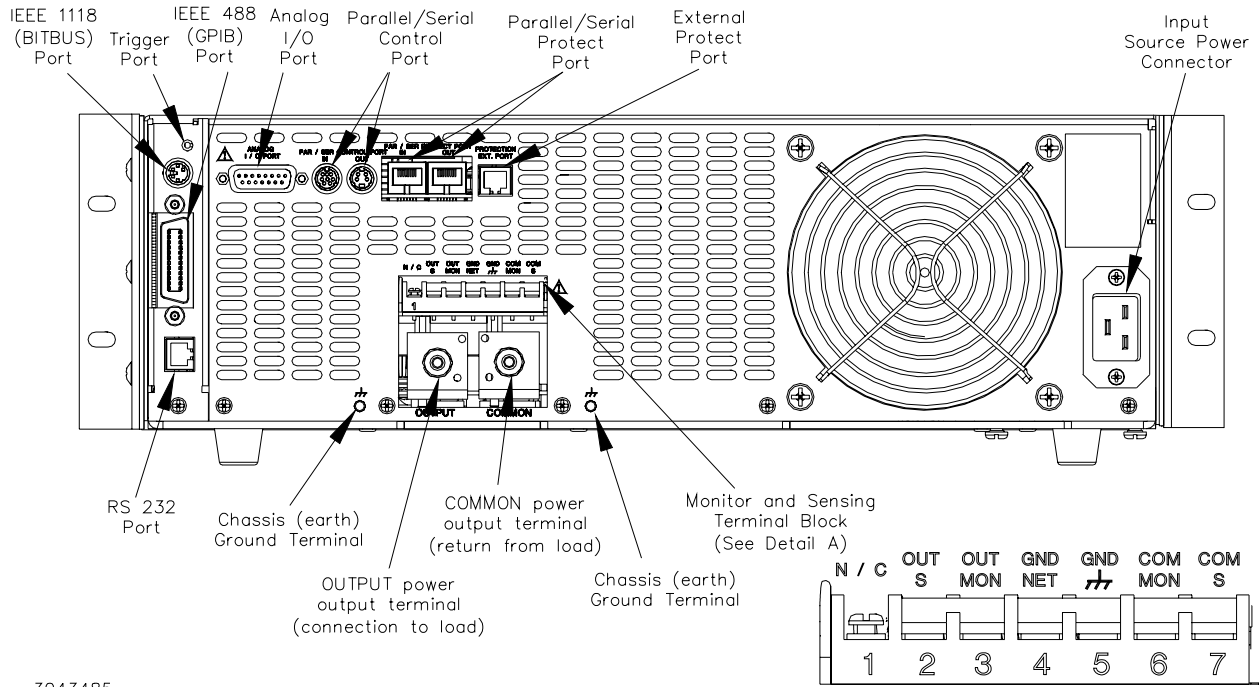
**GPIB CONNECTIONS.** Your computer must have a GPIB interface card installed. Connect the power supply to the computer's GPIB interface card. Use a standard GPIB interface cable at the GPIB port on the rear panel (see Figure 3). The default GPIB address is 6; refer to the Operator's Manual to change it.

**RS 232 CONNECTIONS.** Connect the BOP 1KW to a modem using a Null Modem patch cable at the RS 232 port located on the rear panel (See Figure 3). A Null Modem cable is not required for older MAC computers with D-sub serial port in which the

RXD and TXD line transposition is accomplished via external hardware. The default baud rate is 38400; refer to the Operator Manual to change it.

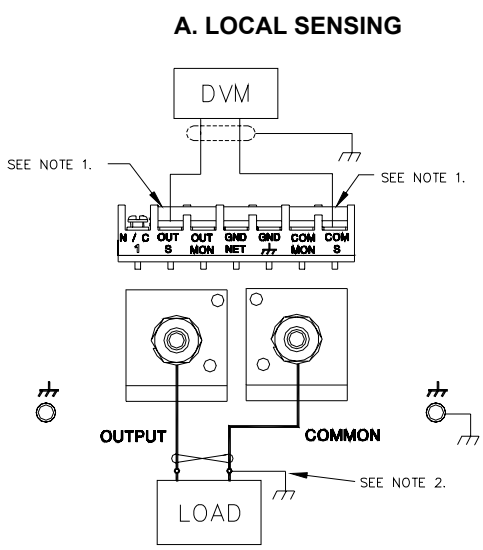


**FIGURE 2. BOP 1KW SERIES, FRONT PANEL CONTROLS AND INDICATORS**



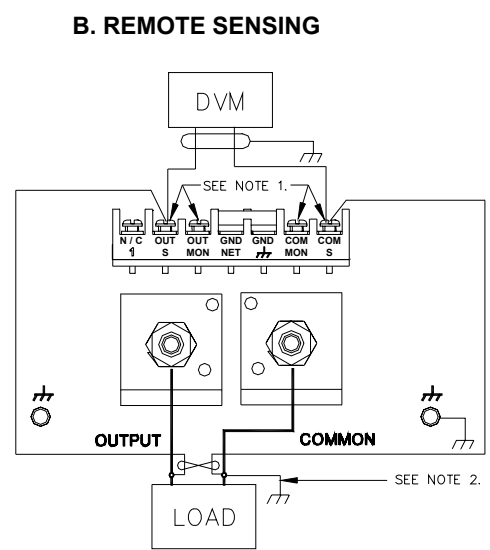
3043485

**FIGURE 3. BOP 1KW SERIES, REAR PANEL VIEW, LINKS INSTALLED FOR LOCAL SENSING**



- NOTES:
1. USE LINKS (SUPPLIED) FOR CONNECTIONS BETWEEN (OUT S) AND (OUT MON) AND BETWEEN (COM S) AND (COM. MON) FOR LOCAL SENSING.
  2. GROUNDED LOAD SHOWN; REMOVE GROUND CONNECTION FOR ISOLATED LOAD.

3042550



- NOTES:
1. LINKS BETWEEN (OUT S) AND (OUT MON) AND BETWEEN (COM S) AND (COM MON) MUST BE REMOVED FOR REMOTE SENSING.
  2. GROUNDED LOAD SHOWN; FOR ISOLATED LOADS, REMOVE GROUND CONNECTION

3042551

**FIGURE 4. LOAD CONNECTION**

## VIII — OPERATION.

Additional features covered in the Operator Manual are: Quick Boot (eliminating the power-up displays), use of the internal relay, operation via the LAN interface or analog signals and setting coarse/fine adjustment preference of the VOLTAGE and CURRENT controls. An Installation/Operation Summary is also included in the Operator Manual. The Operator Manual also covers the GPIB and RS 232 interfaces, including the use of the drivers downloadable from:

[www.kepcopower.com/drivers/drivers-dl3.htm](http://www.kepcopower.com/drivers/drivers-dl3.htm)  
#bop1k.

### TURNING THE POWER SUPPLY ON.



#### CAUTION:

**DO NOT repeatedly toggle the circuit breaker/switch as this may damage the unit.**

Set POWER ON/OFF circuit breaker/switch on front panel to ON. If actuator does not lock when released, wait a few seconds before trying again. The circuit breaker is “trip-free” design; if overload exists, contacts cannot be held closed by actuator.

- When the power supply is turned on, it performs a brief self-test that includes testing the three processors (analog, interface and display), then displays the power-up screen (see Figure 5). If an error is detected, the FAULT indicator will light, information about the error will be briefly displayed on the LCD.
- If the unit powers up in REMOTE mode, press **F1** to set the unit to LOCAL mode.
- If the display is not viewable, press **F3** twice. The display will cycle through the range of contrast settings. Press **F3** again to lock in the preferred contrast.

**ACCESSING THE MENUS.** From the power-up screen, pressing the Function keys indicated on the LCD opens the associated menu. The menu opened may list submenus that may be opened either directly by pressing the associated Function keys, or by highlighting an item on the list and pressing the View/Modify function key. Menus and submenus will display a list of parameters, with the top one highlighted. The function key assignments can vary, but generally offer the following choices:

- **F1** allows the highlighted parameter to be viewed or modified. After changing the param-

eter, the following choices are available: **F4** - SAVE or **ENTER** to save the change, **F5** - EXIT to abort the change and exit to the previous menu.

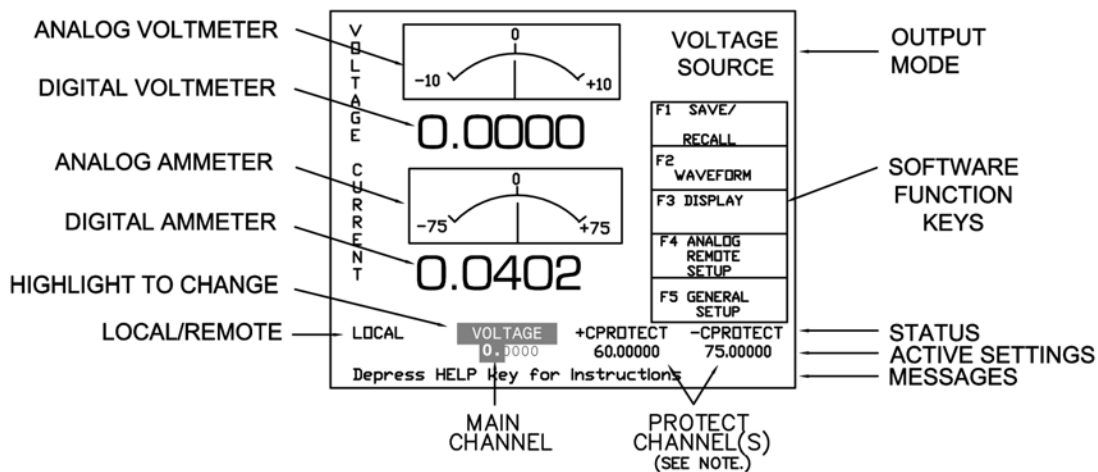
- **F2** - RESTORE DEFAULT restores factory defaults for the parameters displayed (except for GPIB address). The factory defaults may be saved as power-up defaults by pressing **F4**.
- **F3** - The function varies, depending on the menu. In most cases **F3** is used to abort a change without applying the modified setting. From the power-up screen **F3** is used to adjust contrast. In the Revisions/TEST submenu of the General Setup Menu, **F3** is used to execute a test.
- **F4** - SAVE FOR POWER-UP Saves the configuration shown as a power-up setting so the changes will not be lost when the unit is turned off.
- **F5** - APPLY EXIT applies the current (changed) setting without saving for power-up and exits to the previous menu or to the power-up screen, EXIT leaves the current menu without saving or applying changes.

The menu structure is as follows (NOTE: **BOLD** = Factory Default):

Power-up Screen (Power up menu)

- **F1** - Save/Recall
  - Saved Setups: Recall one of 99 saved setups.
  - Saved Setup Details: Mode (voltage/current), main channel reference (internal/external/external reference level) and setting, protection limit (internal/external/lesser limit) and setting(s), output status (on/off)
- **F2** - Waveform
  - Saved Waveforms: Choose one of 16 saved waveforms.
  - New Waveform Settings: Name (max. 10 characters), protection settings, count, mode (voltage/current)
  - Waveform Settings: Name, protection settings, count, segment list, mode
  - Segment Details: Type (square/±ramp/triangle/sine/level), frequency or period, p-p amplitude, offset, start/stop angle for sine and triangle, initial/repeat
- **F3** - Display
  - Display and Beep Settings: Display (meters/graphics (12 choices)), background (white/black), contrast, beep (On/Off/Error only)

- **F4** - Analog Remote Setup
- Analog Remote Settings: Reference input (**internal**/external/external reference level), protection limit (**internal**/external/lesser limit), external mode (enable/**disable**)
- **F5** - General Setup
- Interface Settings: Data format (**SCPI**/CII), GPIB address (default = **6**), \*RST sets Output (**on**/off), Device clear (**SCPI**/MATE), Serial Baud (**Off**/9600/19200), Xon/Xoff (**enable**/disable), prompt (enable/**disable**)
- Max/Min Settings: Protect Entry (**Bipolar**/Independent); for voltage mode: +Voltage max, -Voltage min, ±CProtect max/min; for current mode: +Current max, -Current min, ±VProtect max/min
- Load Type: **Active**/Resistive/Battery
- Revisions/Test: (Tests: display, keypad, interface, serial, analog and output)
- Calibration: Voltage, Current and External and Controls calibration
- Power-up Settings: Mode (**Voltage**/Current), Main channel reference (**Internal**/External/External Reference Level), protect channel type (**Internal**/External/Lesser Limit), Voltage Protect Limit (current mode), Current Protect Limit (voltage mode) output **on**/off
- Password
- Password Settings: Menu protection (Interface/Max-Min/Load/Test/Power-up/Keypad @ local/Keypad@power-up), Save Display chg (Enable/**Disable**), Passwords (Main/Admin1/Admin2 or Unprotected)
- Series/Parallel: Configuration (Standalone/Parallel/Series/Master 2X2/Master 3X2); for parallel or series: Unit Type (Standalone/Master+1 to+4/Slave #1 to #5) and Connection Type: shows Series or Parallel).



3042519-1  
 NOTE:  
 WHEN SET TO BIPOLAR, ONLY ONE PROTECTION FIELD IS DISPLAYED.  
 WHEN SET TO INDEPENDENT, TWO PROTECTION FIELDS ARE DISPLAYED AS SHOWN HERE.

FIGURE 5. POWER-UP SCREEN SHOWING GRAPHIC METERS

## HOW TO MODIFY A PARAMETER.

First access the parameter by accessing the proper menu as described above. To modify a parameter listed in a menu or submenu, proceed as follows:

1. Highlight the parameter using the **↑** and **↓** keys.
2. When the desired choice is highlighted, press **F1** to modify the active setting. The choices are displayed with the active setting highlighted. In the case of numerals, the units digit is highlighted.
  - To change a numeric setting, press the number keys, then press **ENTER** to program the numbers entered. Use the **CLEAR** key to clear numbers entered and start over. The **ADJUST** control can also be used to increment or decrement the highlighted digit.

Pressing **ADJUST** while rotating adjusts the least significant digit. If the output is on (unit not in Standby) changes made using the **ADJUST** control are immediately applied to the output.

- For alphanumeric characters use multiple presses of the number keys for letters or symbols: **0** (space), **1** (+, -, /), **2** (ABC), **3** (DEF), **4** (GHI), **5** (JKL), **6** (MNO), **7** (PQRS), **8** (TUV), **9** (WXYZ). Use the **→** key to highlight the next character. As an alternative, the **↓** or **↑** keys or **ADJUST** control will scroll through numbers, and letters and symbols. Use the **CLEAR** key to clear the entire alphanumeric field and start over

3. Press **F4** to apply the change and return to the menu (to change another parameter, repeat steps 1 and 2). To abort (return to the menu without applying the change), press **F5**.

NOTE: Press **HELP** key for more information, press **HELP** again to see multiple screens; press **CLEAR** key to exit the help screen.

**ADJUSTING LCD BRIGHTNESS, CONTRAST AND BACKGROUND** From the power-up screen, (Figure 5), press **F3** twice to initiate contrast adjustment. The contrast gradually alternates between light and dark. When the contrast is acceptable, press **F3** to apply the change and exit contrast adjust. Use the **→** and **←** keys for fine adjustment of contrast. Contrast can also be adjusted from the power-up screen by pressing **F3** once, then pressing **→** and **←** as needed for fine adjustment.

To change the background, press **F3** from the power-up screen, Highlight Background, press **F1**, highlight Black or White, then **F4** to save. Press **F4** exit and save for power-up or **F5** to apply the changes (without saving for power-up) and exit.

**ENABLING/DISABLING AUDIBLE BEEPS** From the power-up screen, press **F3**, then modify the setting. Even though audible beeps are set to off, the beeps will still sound upon power-up or detection of a power supply fault.

**SETTING VOLTAGE OR CURRENT MODE** The BOP uses two separate channels, one to set output voltage or current and one to set the corresponding protection limit. The main channel is determined by the **MODE** key (in local mode) which alternately selects either Voltage mode or Current mode or by SCPI command (in digital remote mode). The protection channel is determined automatically by the main channel selected. When Voltage mode is selected, the current protection channel is active, and when Current mode is selected, the Voltage protection channel is active.

**PROGRAMMING VOLTAGE OR CURRENT AND ASSOCIATED PROTECT LIMITS** From the power-up screen the settable voltage/current parameters are displayed at the bottom of the LCD above the **HELP** message. Use **↑** or **↓** to highlight the main or protect channel.

1. To verify that the unit is configured for internal references press **F4** from the power-up screen and verify that Reference Input and Protection Limit are set to Internal, and External Mode is set to Disable. If necessary to change a setting, use **↑** or **↓** to highlight the parameter, and press **F1** to modify. Highlight the desired selection and press **F4** to save, then press **F4** to save for power-up or **F5** to exit. If analog programming is desired, refer to Operator's Manual.
2. Verify that the load has been configured properly to ensure that the unit behaves as expected when the output is off (see PAR. for details).
3. Press **MODE** key to select the main channel (VOLTAGE or CURRENT); the associated PROTECT channel is automatically selected and displayed.
4. Set the output on or off as desired using the **STANDBY** key. The output is off (disabled) when the **STANDBY** indicator is lit, on (enabled) when not lit.
5. Use **↑** or **↓** to highlight the main channel. There are two ways to program the output in local mode. These methods can be used either when the output is disabled (**STANDBY** indicator lit) or enabled.



**CAUTION:**

**When the ADJUST control is rotated, the active parameter is immediately effective if the output is enabled (on = STANDBY indicator not lit). The voltage/current applied to the load changes as the ADJUST control is rotated.**

- Use the **ADJUST** control to increase or decrease the main channel setting (e.g., voltage when the unit is in voltage mode). Start with the most significant digit of the desired value, then use **→** to highlight the next digit. For fine adjustment press the **ADJUST** control in while rotating the knob to modify the least significant digit.
- Enter the desired value on the keypad using the number keys. For example, to program the BOP to 75.8V, press the following keys in order **7** **5** **.** **8** then press **ENTER**. For fine adjustment use **↑** and **↓** to modify the least significant digit. To correct the entry before

activation press the **CLEAR** key to set the value to zero and start over. When the desired value is displayed, press **ENTER**. This causes the new value to appear at the output and be applied to the load if the output is enabled.

6. To program the corresponding Protect channel, press or as necessary to highlight the Protect channel. Then set the value using either of the two methods described above. If the Protect Entry setting is set to Independent, separate entries for the positive and negative protect channel are possible. Otherwise the value entered is applied to both positive and negative protect channels.

**NOTE:** The BOP can be configured to show the protection limits as either a single value that applies to both protection channels or show individual settings for positive and negative protection limits. See Operator's Manual for details

**SOFTWARE LIMITS.** Software limits prevent programming of the main channel or the Protect channel beyond the software limit value. Refer to Operator's Manual for a full explanation of software limits.

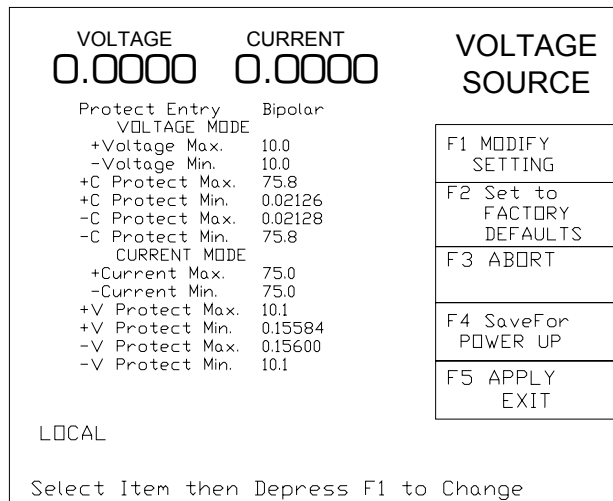
**Changing Main Channel Software limit.**

This procedure allows the user to determine the maximum value of voltage or current that can be programmed.

1. Press from the power-up screen to enter the General Setup menu, then highlight Max/Min Settings.
2. Press to enter the Max/Min Settings submenu (Figure 6). (If a Password is required, see Operator's Manual for instructions.)
3. Highlight the voltage or current max/min value and press to change it. Software limits are absolute values (do not use minus sign for negative limits). Use number keys to change the setting, then to save.
4. When complete, press to save for power-up, to abort, or to apply the changes (without saving for power-up) and exit.
5. Upon return to the power-up screen, the main channel (voltage or current) is compared against the main channel limits in effect. If the main channel exceeds the limit, it is set to zero.
6. Highlight the ±CPROTECT or ±VPROTECT max/min value and press to change it. Software limits are absolute values (do not use minus sign for negative limits). Use number keys to change the setting. Press to save, or to abort.
7. When complete, press to save for power-up, or to abort, or to apply the changes (without saving for power-up) and exit.

Upon return to the power-up screen, the new protection limit (voltage or current) is compared against the protection limits in effect. If the new protection limit setting is below the existing setting for the protection limit, the protection channel (voltage or current) is set to zero.

**NOTE:**  
VALUES SHOWN ARE  
TYPICAL FOR  
BOP 10–75MG.



3042519-9

**FIGURE 6. MAX/MIN SETTING MENU**

**DETERMINING HOW THE UNIT RESPONDS WHEN OUTPUT IS OFF (LOAD TYPE)**

The BOP supports three Load Type selections (see Table 5) which determine how the power supply responds when the output is off: ACTIVE, RESISTIVE and BATTERY. The Load Type selection does not affect

the settings of the power supply for ON state; it only affects the main internal reference level and the protection levels during the OFF state.

**TABLE 5. POWER SUPPLY BEHAVIOR WHEN OUTPUT IS SET TO OFF**

LOAD TYPE SETTING	If unit was in Voltage Mode when output OFF command issued.	If unit was in Current Mode when output OFF command issued.
ACTIVE	<ul style="list-style-type: none"> <li>• Unit remains in voltage mode.</li> <li>• Voltage set to zero.</li> <li>• Both ± Current Protect set to maximum.</li> <li>• Both ± Voltage Limit remain at maximum.</li> </ul>	<ul style="list-style-type: none"> <li>• Unit set to voltage mode.</li> <li>• Voltage set to zero.</li> <li>• Both ± Current Protect remain at maximum.</li> <li>• Both ± Voltage Limit set to maximum.</li> </ul>
RESISTIVE	<ul style="list-style-type: none"> <li>• Unit remains in voltage mode.</li> <li>• Voltage set to zero.</li> <li>• Both ± Current Protect set to minimum box values.</li> <li>• Both ± Voltage Limit. remain at maximum.</li> </ul>	<ul style="list-style-type: none"> <li>• Unit remains in current mode.</li> <li>• Current set to zero.</li> <li>• Both ± Current Protect set to minimum box values.</li> <li>• Both ± Voltage Limit set to maximum,</li> </ul>
BATTERY	<ul style="list-style-type: none"> <li>• Unit set to current mode.</li> <li>• Current set to zero.</li> <li>• Both ± Voltage Protect. remain at maximum.</li> <li>• Both ± Current Limit set to maximum.</li> </ul>	<ul style="list-style-type: none"> <li>• Unit remains in current mode,</li> <li>• Current set to zero.</li> <li>• Both ± Voltage Protect set to maximum.</li> <li>• Both ± Current Limit remain at maximum.</li> </ul>

**WARNING**



For inductive loads, and especially superconducting magnet type loads, the inherent offset of the BOP in the OFF state may generate significant current in the circuit. A properly rated switch in parallel with a resistor must be connected between the power supply and the load. The switch must be open and the BOP front panel LCD must read 0V, 0A before removing or installing connections between BOP and load.

**Active.** Active mode (default setting) is necessary for the power supply to function properly and safely with inductive loads and constant-current-type active electronic loads. Active mode can also be used with resistive loads. Table 5 indicates how the power supply responds to a command to go from Output ON to OFF. When the output is disabled, the unit is set to voltage mode, voltage is set to zero and both current protect and voltage limit are set to maximum. When

the unit is enabled, the pre-existing settings for voltage, current protect and voltage limit are restored.

**WARNING**



For both inductive loads and constant-current-type active electronic loads when the BOP output is set to OFF, a path is provided for absorbing either the energy accumulated in the reactance of the load during the ON state, or energy delivered by an electronic load. This prevents damage to the load and power supply as well as providing safety for the user. However, In addition to the built-in safety features, constant-current-type active electronic loads must be adjusted to zero and the BOP front panel LCD must read 0V, minimum current, before handling the power supply-to-load connections.

**Resistive.** This mode, as the name suggests, is useful for resistive loads. Table 5 indicates how the power supply responds to a command to go from Output ON to OFF.



#### WARNING

**Accessing the BOP after the output is disabled in BATTERY mode is hazardous because (1) high current arcing is possible and (2) either the external battery voltage, or the voltage ( $\pm$ Voltage Protection max) on the BOP output terminals may be dangerous. Therefore, for battery and constant-voltage-type active electronic loads it is recommended that two properly rated external switches be installed for safety: one in series with the battery, and one across the BOP output. After the unit is set to OFF, first open the switch in series with the battery, then close the switch across the BOP output to ensure safety before handling BOP connections. When connecting the battery, the switch across the output should be opened after the connections are complete and then the switch in series with the battery should be closed. If the constant-voltage-type active electronic load is adjusted to zero before handling the power supply-to-load connections, only the switch across the BOP output is required.**

## IX — ADDITIONAL FEATURES.

The user is urged to refer to the Operator's Manual for full explanations all BOP 1KW features, including:

- Passwords - three independent levels of access
- Changing the Default Power up Settings
- Digital Remote Operation - using SCPI commands via RS 232 or GPIB ports
- Analog Remote Operation - via Analog I/O port
- Details about Protect Limits and Software-controlled limits

**Battery.** This mode is necessary for the power supply to function properly and safely with either battery or constant-voltage-type active electronic loads. This mode prevents the battery from discharging during the OFF state. When the output is disabled (set to OFF), the BOP will go to current mode, current will be set to zero, with voltage protect and current limit set to maximum. In this way the battery will not be discharged while the output is OFF. For constant-voltage-type active electronic loads this mode stops energy flow during the OFF state. Table 5 indicates how the power supply responds to a command to go from Output ON to OFF.

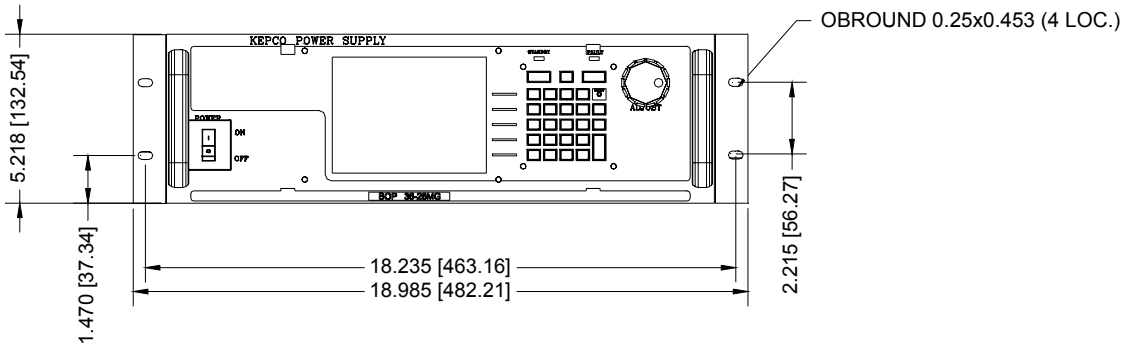
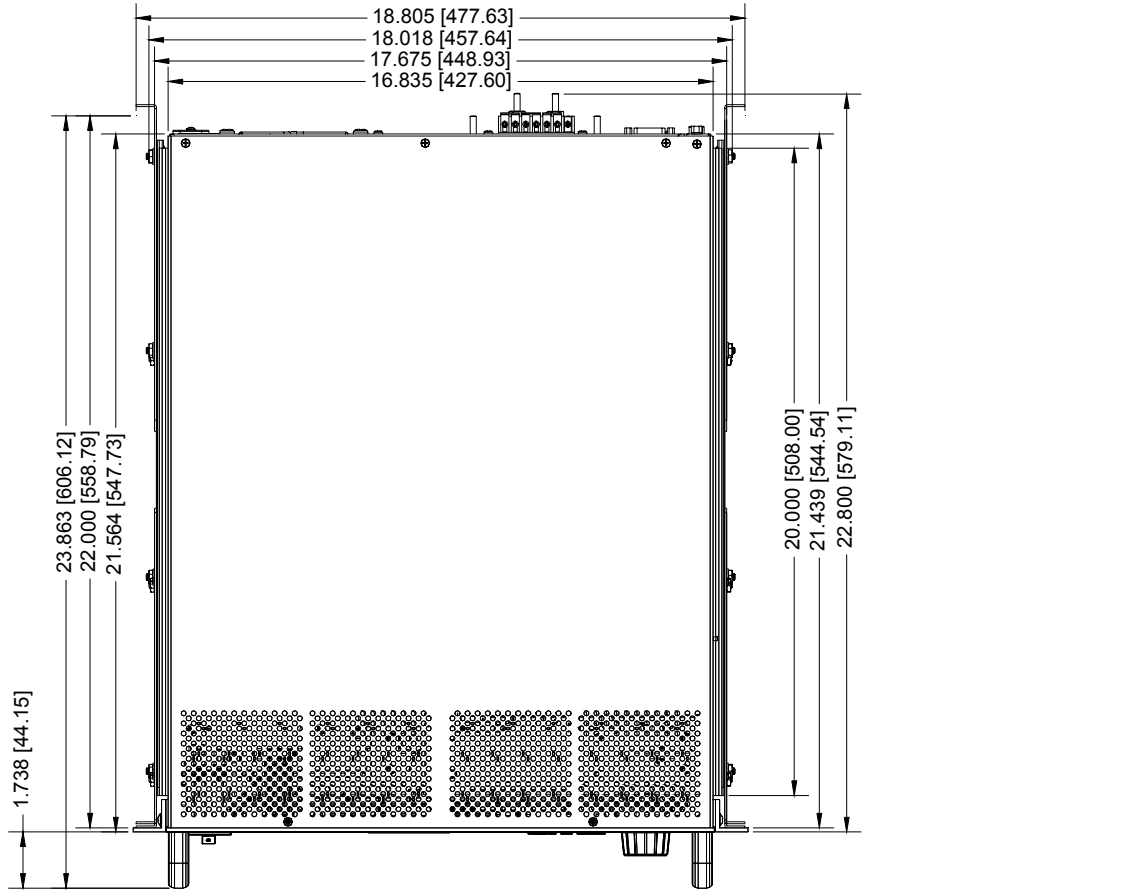
**CONFIGURE LOAD TYPE.** To configure, press **F5** from the power-up screen, then highlight Load Type and press **F1** to modify. (If a Password is required, see Operator's Manual for instructions.) Highlight Active, Resistive or Battery (see explanations and associated WARNINGS above) and press **F4** to save. Then press **F4** to save for power-up, **F3** to abort, or **F5** to apply the changes (without saving for power-up) and exit. After configuring, the new setting will be effective when the power supply goes from output on to output off.

To restore factory default (Active), press **F5** from the power-up screen, highlight Load Type, press **F1**, then press **F2** to restore default. Press **F4** to save for power-up or **F5** to exit

#### ENABLING/DISABLING OUTPUT POWER.

The BOP output can be disabled (OFF) or enabled (ON) by toggling the **STANDBY** key in local mode. The behavior of the unit when disabled depends on the Load Type setting (See "Determining How the Unit Responds when Output is OFF (Load Type)" on page 12. and Table 5 for details).

- Storing/Recalling Power Supply Output Settings
- Waveform Generation - Sine, Triangle,  $\pm$ Ramp, Square and Level segments. Local operation allows up to 16 waveforms, maximum 10 segments per waveform. Remote operation allows 1 waveform, maximum of 126 segments, or using LIST commands.
- Operator Testing
- Calibration - via either local keypad or remote SCPI commands
- Parallel/Series Configurations -increase current capability, voltage capability, or both.

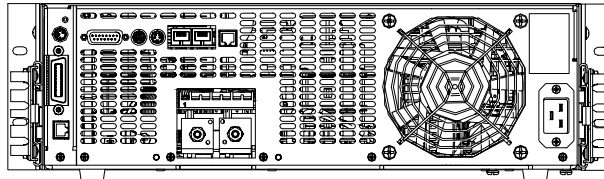


NOTES:

1. MATERIAL: A) CHASSIS: #11 GA. C.R.S.  
 B) FRONT PANEL: 1/8 THICK 6061-T6 ALUMINUM.  
 C) COVER: #16 GA. C.R.S.  
 D) BACK PLATE: 0.064 THICK 5052-H32 ALUMINUM.
2. FINISH: A) CHASSIS & COVER : CADMIUM PLATE WITH CROMATE WASH.  
 B) BACK PLATE: IRIDITE GOLD  
 C) FRONT PANEL: SEE 1311145 PAGE 2 OF 3.
3. DIMENSION IN PARENTHESES ARE IN MILLIMETERS.
4. TOLERANCES ARE  $\pm 1/32$  (0.8), EXCEPT AS NOTED.
5. PRIOR TO INSTALLATION, REMOVE FOUR FEET.
6. OPTIONAL SLIDES (KEPCO KIT P/N CS 04) SHOWN INSTALLED.

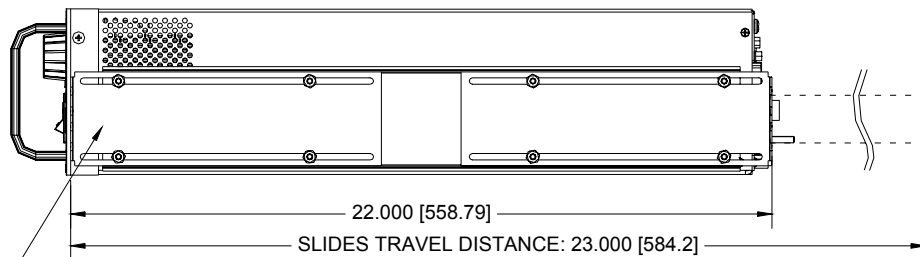
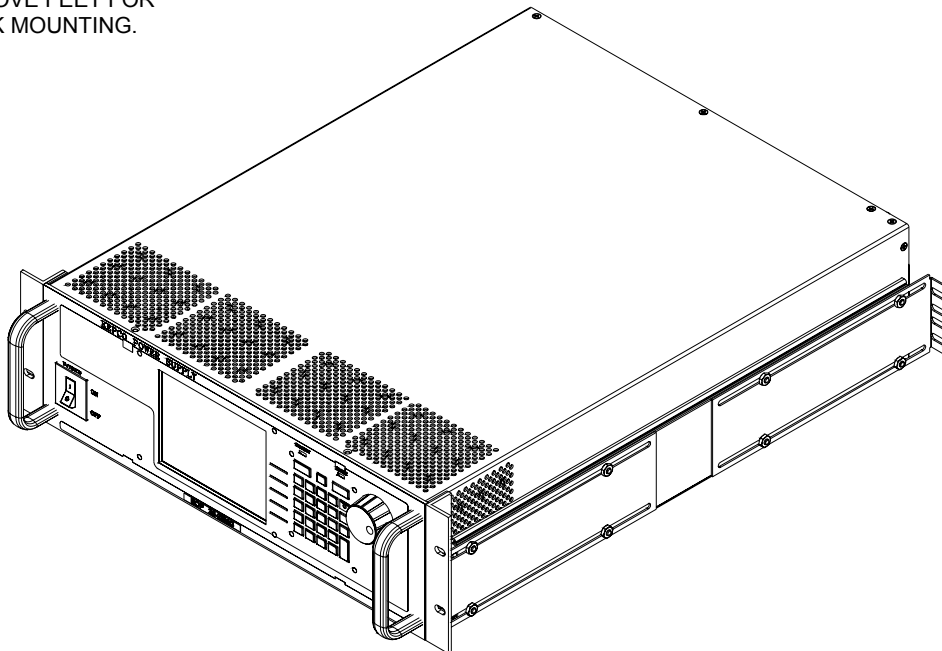
3010256

**FIGURE 1. BOP 1KW OUTLINE DIMENSIONS (SHEET 1 OF 2)**



REAR VIEW

REMOVE FEET FOR RACK MOUNTING.



SEE NOTE 6.

3010256

FIGURE 1. BOP 1KW OUTLINE DIMENSIONS (SHEET 2 OF 2)

