

TABLE OF CONTENTS

SECTION	PAGE
SECTION 1 - INTRODUCTION	
1.1	Scope of Manual 1-1
1.2	General Description..... 1-1
1.2.1	Measurements..... 1-1
1.2.2	Enhanced Operation..... 1-2
1.3	Specifications 1-2
1.3.1	BIT 4882 Compatibility..... 1-4
SECTION 2 - INSTALLATION	
2.1	Unpacking and Inspection 2-1
2.2	Set Start-up Defaults 2-1
2.2.1	Set (GPIB) Device Address 2-2
2.2.2	Power Supply Identification 2-2
2.3	Installation of Interface Card into the BOP 2-4
2.4	Input/Output Signals..... 2-6
2.5	Initial Check-out Procedure 2-7
SECTION 3 - CALIBRATION	
3.1	Equipment Required..... 3-1
3.2	BOP Power Supply Adjustments..... 3-1
3.2.1	Adjustment of the Bop ± 10 Volt Calibration Controls (R31, R32)..... 3-1
3.2.2	Adjustment of the Ammeter Zero (R50)..... 3-1
3.3	Calibration of BIT 4886 Interface Card 3-3
3.3.1	Manual calibration..... 3-6
3.3.2	Calibration of BIT 4886 Interface Card using the VISA Driver Soft Panel 3-9
3.3.2.1	Calibration Basics 3-10
3.3.2.2	Calibration Procedure 3-11
SECTION 4 - OPERATION	
4.1	General..... 4-1
4.1.1	Programming Techniques to Optimize Power Supply performance 4-1
4.1.1.1	Example of Proper Programming..... 4-1
4.1.1.2	Making Sure the Previous Command is Complete 4-1
4.2	Initialization of the BIT 4886 Card 4-3
4.2.1	Initialization using CVI Driver - GPIB Port Only 4-3
4.2.2	Initialization using SCPI Commands and GPIB Port 4-4
4.2.3	Initialization using SCPI Commands and RS 232 Port 4-5
4.2.4	Password Setup..... 4-5
4.2.4.1	Forgotten Passwords 4-5
4.3	Built in Test..... 4-6
4.3.1	Power-up Test 4-6
4.3.2	Confidence Test..... 4-6
4.3.3	BOP test 4-6
4.4	IEEE 488 (GPIB) Bus Protocol 4-7
4.5	RS232-C Operation 4-8
4.5.1	Serial INterface 4-9
4.5.2	RS 232 Implementation 4-9
4.5.2.1	Echo Mode..... 4-11
4.5.2.2	XON XOFF Method..... 4-11
4.5.2.3	Isolating RS 232 Communication Problems 4-11
4.5.3	Using SCPI commands for RS 232 Communication. 4-12
4.6	SCPI Programming 4-12
4.6.1	SCPI Messages 4-12
4.6.2	Common Commands/Queries 4-12
4.6.3	SCPI Subsystem Command/Query Structure..... 4-12
4.6.3.1	Initiate Subsystem..... 4-13

TABLE OF CONTENTS

SECTION		PAGE
4.6.3.2	Measure Subsystem	4-13
4.6.3.3	[Source:]voltage And [Source:]current Subsystems.....	4-13
4.6.3.4	Output Subsystem.....	4-14
4.6.3.5	List Subsystem.....	4-14
4.6.3.5.1	Required LIST Commands.....	4-14
4.6.3.5.2	Other Required Commands	4-14
4.6.3.5.3	Other Useful Commands.....	4-15
4.6.3.5.4	Optional Commands.....	4-15
4.6.3.6	Status Subsystem	4-15
4.6.3.7	System Subsystem	4-15
4.6.4	Program Message Structure	4-15
4.6.4.1	Keyword	4-16
4.6.4.2	Keyword Separator	4-16
4.6.4.3	Query Indicator.....	4-17
4.6.4.4	Data.....	4-17
4.6.4.5	Data Separator.....	4-17
4.6.4.6	Message Unit Separator	4-17
4.6.4.7	Root Specifier.....	4-17
4.6.4.8	Message Terminator	4-17
4.6.5	Understanding The Command Structure	4-18
4.6.6	Program Message Syntax Summary	4-18
4.6.7	SCPI Program Example.....	4-19
4.7	Enhanced Operation.....	4-19
4.7.1	Error Detection.....	4-20
4.7.2	Limit Channel Control	4-20
4.7.3	Using and Saving System Variables.....	4-21
4.7.4	Flash Memory EEPROM Operation.....	4-21
4.7.4.1	Calibration Storage	4-24

APPENDIX A - SCPI COMMON COMMAND/QUERY DEFINITIONS

A-1	Introduction.....	A-1
A.2	*CLS — Clear Status Command	A-1
A.3	*ESE — Standard Event Status Enable Command.....	A-1
A.4	*ESE? — Standard Event Status Enable Query.....	A-2
A.5	*ESR — Event Status Register Query.....	A-2
A.6	*IDN? — Identification Query.....	A-2
A.7	*OPC — Operation Complete Command	A-2
A.8	*OPC? — Operation Complete Query	A-3
A.9	*OPT? — Options Query	A-4
A.10	*RCL — Recall Command	A-4
A.11	*RST — Reset Command.....	A-4
A.12	*SAV — Save Command.....	A-4
A.13	*SRE — Service Request Enable Command	A-4
A.14	*SRE? — Service Request Enable Query	A-5
A.15	*STB? — Status Byte Register Query	A-5
A.16	*TRG — Trigger Command	A-5
A.17	*TST? — Self Test Query	A-5
A.18	*WAI — Wait-To-Continue Command	A-5

APPENDIX B - SCPI COMMAND/QUERY DEFINITIONS

TABLE OF CONTENTS

SECTION	PAGE
B.1	Introduction..... B-1
B.2	Numerical Values B-2
B.3	CALibrate:CPRotect Command B-2
B.4	CALibrate:STATus Command B-2
B.5	CALibrate[:STATus]? Query..... B-2
B.6	CALibrate:CURRent Command B-3
B.7	CALibrate:DATA Command B-3
B.8	CALibrate:DPOT Command B-3
B.9	CALibrate:LCURR Command B-4
B.10	CALibrate:LVOLT Command B-4
B.11	CALibrate:SAVE Command B-4
B.12	CALibrate:VOLTage Command B-4
B.13	CALibrate:VPRotect Command..... B-4
B.14	CALibrate:ZERO Command B-4
B.15	INITiate[:IMMediate] Command B-5
B.16	INITiate:CONTInuous Command B-5
B.17	INITiate:CONTInuous Query B-5
B.18	MEASure[:SCALar]:CURRent[:DC]? Query B-5
B.19	MEASure[:VOLTage][:SCALar][:DC]? Query B-5
B.20	OUTPut[:STATe] Command..... B-5
B.21	OUTPut[:STATe] Query B-5
B.22	[SOURce:]FUNctioN:MODE Command B-6
B.23	[SOURce:]FUNctioN:MODE? Query B-6
B.24	[SOURce:]FUNctioN:MODE:TRIGger B-6
B.25	[SOURce:]FUNctioN:MODE:TRIGger? Query B-6
B.26	[SOURce:]LIST:CLEAr Command B-6
B.27	[SOURce:]LIST:COUNt Command..... B-6
B.28	[SOURce:]LIST:COUNt? Query B-6
B.29	[SOURce:]LIST:COUNt:SKIP Command B-7
B.30	[SOURce:]LIST:COUNt:SKIP? Query B-7
B.31	[SOURce:]LIST:CURRent Command..... B-7
B.32	[SOURce:]LIST:CURRent? Query B-7
B.33	[SOURce:]LIST:CURRent:POINts? Query B-7
B.34	[SOURce:]LIST:DIRectioN Command B-8
B.35	[SOURce:]LIST:DIRectioN? Query B-8
B.36	[SOURce:]LIST:DWELI Command B-8
B.37	[SOURce:]LIST:DWELI? Query..... B-8
B.38	[SOURce:]LIST:DWELI:POINts? Query B-8
B.39	[SOURce:]LIST:GENeratioN Command B-12
B.40	[SOURce:]LIST:GENeratioN? Query B-12
B.41	[SOURce:]LIST:QUERy Command B-12
B.42	[SOURce:]LIST:QUERy? Query B-12
B.43	[SOURce:]LIST:SEQuence Command..... B-12
B.44	[SOURce:]LIST:SEQuence? Query B-12
B.45	[SOURce:]LIST:VOLTage Command..... B-13
B.46	[SOURce:]LIST:VOLTage? Query B-13
B.47	[SOURce:]LIST:VOLTage:POINts? Query B-13
B.48	[SOURce:]CURRent[:LEVel][:IMMediate][:AMPLitude] Command..... B-13
B.49	[SOURce:]CURRent[:LEVel][:IMMediate][:AMPLitude] Query B-13
B.50	[SOURce:]CURRent:MODE Command B-14
B.51	[SOURce:]CURRent:MODE? Query B-15
B.52	[SOURce:]CURRent[:LEVel]RANGe Command B-15
B.53	[SOURce:]CURRent[:LEVel]RANGe? Query B-15
B.54	[SOURce:]CURRent[:LEVel]RANGe:AUTO Command B-15
B.55	[SOURce:]CURRent[:LEVel]TRIGgered[:AMPLitude] Command..... B-15
B.56	[SOURce:]CURRent[:LEVel]TRIGgered[:AMPLitude]? Query B-15
B.57	[SOURce:]VOLTage[:LEVel][:IMMediate][:AMPLitude] Command..... B-16

TABLE OF CONTENTS

SECTION		PAGE
B.58	[SOURce:]VOLTage[:LEVel][:IMMediate][:AMPlitude]? Query.....	B-16
B.59	[SOURce:]VOLTage:MODE Command.....	B-16
B.60	[SOURce:]VOLTage:MODE? Query.....	B-17
B.61	[SOURce:]VOLTage[:LEVel]:RANGe Command.....	B-17
B.62	[SOURce:]VOLTage[:LEVel]RANGe? Query.....	B-17
B.63	[SOURce:]VOLTage[:LEVel]RANGe:AUTO Command.....	B-17
B.64	[SOURce:]VOLTage[:LEVel]:TRIGgered[:AMPlitude] Command.....	B-17
B.65	[SOURce:]VOLTage[:LEVel]:TRIGgered[:AMPlitude]? Query.....	B-17
B.66	STATus:OPERation:CONDition Query.....	B-18
B.67	STATus:OPERation:ENABle Command.....	B-18
B.68	STATus:OPERation:ENABle? Query.....	B-18
B.69	STATus:OPERation[:EVENT]? Query.....	B-18
B.70	STATus:PRESet Command.....	B-18
B.71	STATus:QUESTionable[:EVENT]? Query.....	B-19
B.72	STATus:QUESTionable:CONDition? Query.....	B-20
B.73	STATus:QUESTionable:ENABle Command.....	B-20
B.74	STATus:QUESTionable:ENABle? Query.....	B-20
B.75	SYSTem:BEEP Command.....	B-20
B.76	SYSTem:COMMunication:SERial:ECHO Command.....	B-20
B.77	SYSTem:COMMunication:SERial:ECHO? Query.....	B-20
B.78	SYSTem:COMMunication:SERial:PACe Command.....	B-20
B.79	SYSTem:COMMunication:SERial:PACe? Query.....	B-20
B.80	SYSTem:ERRor? Query.....	B-21
B.81	SYSTem:ERRor:CODE? Query.....	B-21
B.82	SYSTem:ERRor:CODE:ALL? Query.....	B-21
B.83	SYSTem:PASSword:CENable Command.....	B-21
B.84	SYSTem:PASSword:CDISable Command.....	B-21
B.85	SYSTem:PASSword:NEW Command.....	B-21
B.86	SYSTem:PASSword:STATe? Query.....	B-21
B.87	SYSTem:REMote Command.....	B-21
B.88	SYSTem:REMote? Query.....	B-21
B.89	SYSTem:SECurity:IMMediate Command.....	B-22
B.90	SYSTem:SET Command.....	B-23
B.91	SYSTem:SET? Query.....	B-23
B.92	SYSTem:VERSion? Query.....	B-23

LIST OF TABLES

TABLE	TITLE	PAGE
1-1	Applicability of BIT 4886 Cards to Specific BOP Models	1-1
1-2	BOP Voltage Specifications with BIT 4886 Installed	1-2
1-3	BOP Current Specifications with BIT 4886 Installed	1-2
1-4	Specifications, BIT 4886	1-3
1-5	Command Differences for BIT 4886 card Configured as BIT 4882	1-4
2-1	Items Supplied	2-1
2-2	Device Address Selection	2-3
2-3	Input/Output Pin Assignments	2-6
2-4	RS232C PORT Input/Output Pin Assignments	2-7
2-5	RJ45 to DB9 Adapter Wire Functions	2-7
3-1	Calibration Measurements and Tolerances - Voltage	3-3
3-2	Calibration Measurements and Tolerances - Current	3-4
3-3	Suggested Sense Resistors	3-5
3-4	Calibration Panel Functions	3-10
4-1	Built-in test Error Codes	4-6
4-2	IEEE 488 (GPIB) Bus Interface Functions	4-7
4-3	IEEE 488 (GPIB) Bus Command Mode Messages	4-8
4-4	IEEE 488 (GPIB) Bus Data Mode Messages	4-9
4-5	Enhanced Operation - Error Response	4-22
4-6	Calibration Storage	4-25
A-1	IEEE 488.2 Command/query Index	A-1
A-2	Standard Event Status Enable Register and Standard Event Status Register Bits	A-1
A-3	Service Request Enable and Status Byte Register Bits	A-5
B-1	SCPI Subsystem Command/query Index	B-1
B-2	List Data Table	B-7
B-3	List Sequence Table	B-12
B-4	Operation Condition Register, Operation Enable Register, and Operation Event Register Bits	B-18
B-5	Questionable Event Register, Questionable Condition Register and Questionable Condition Enable Register Bits	B-19
B-6	Error Messages	B-22

LIST OF FIGURES

FIGURE	TITLE	PAGE
1-1	Remotely Controlled Power Supply Configurations Using Kepco Products	viii
2-1	BIT 4886 Switch Locations	2-2
2-2	Installation of Model BIT 4886 into BOP	2-5
2-3	IEEE 488 (GPIB) Connector	2-6
2-4	RJ45 to DB9 Adapter Wiring	2-7
3-1	BOP Power Supply, Internal Calibration Control Locations	3-2
3-2	Current Shunt Connections	3-2
3-3	Main Panel	3-9
3-4	Calibration Panel	3-10
4-1	Programming Example to Verify Previous Command has Completed	4-2
4-2	VISA Driver Start-up	4-4
4-3	BIT 4886 Card Initialization using VISA Driver	4-4
4-4	RS 232 Implementation	4-10
4-5	Tree Diagram of SCPI Commands Used with BIT 4886 Interface Card	4-13
4-6	Message Structure	4-16
4-7	Typical Example of Interface Card Program Using SCPI Commands	4-20
A-1	GPIB Commands	A-3
B-1	Using Calibration Commands and Queries	B-3
B-2	Using LIST Commands for Sawtooth and Triangle Waveforms	B-9
B-3	Using LIST Commands and Queries	B-10
B-4	Programming the Output	B-14
B-5	Using Recall and Trigger Functions	B-16
B-6	Using Status Commands and Queries	B-19
B-7	Setting the Unit to Remote Mode via Serial (RS 232) Port	B-22
B-8	Using System Commands and Queries	B-23

3040800

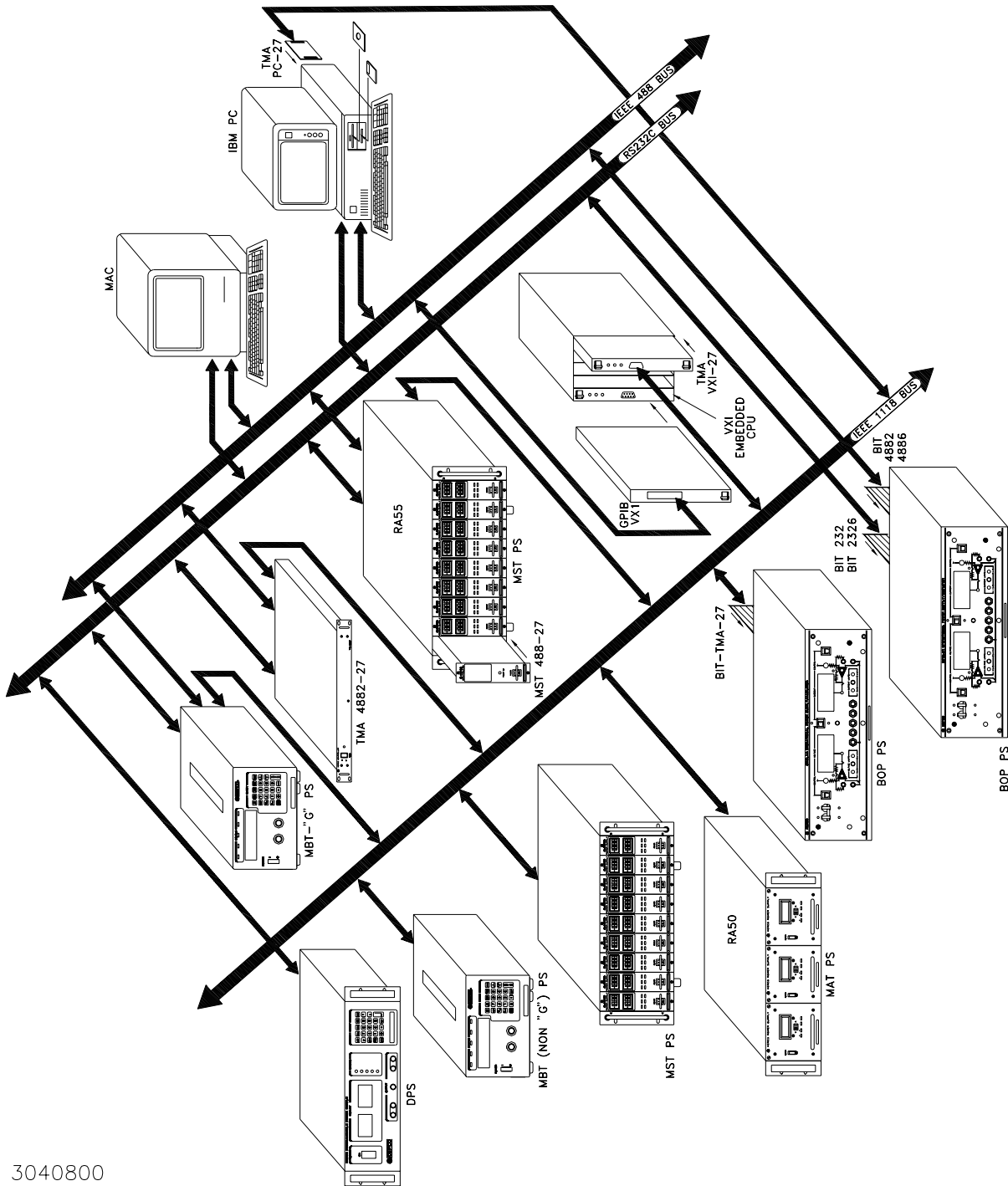

FIGURE 1-1. REMOTELY CONTROLLED POWER SUPPLY CONFIGURATIONS USING KEPCO PRODUCTS

SECTION 1 - INTRODUCTION

1.1 SCOPE OF MANUAL

This manual contains instructions for the installation, operation and maintenance of the BIT 4886 Interface Card manufactured by Kepco, Inc, Flushing, NY, U.S.A.

1.2 GENERAL DESCRIPTION

The Kepco BIT Card Series were designed as an accessory for the Kepco BOP series bipolar power supplies. The BIT 4886 card makes it possible to control the BOP output by means of digital input signals via the IEEE 488.2 bus using SCPI commands (see Figure 1-1). The BIT 4886 card acts as an interface between the digital data bus and the BOP, accepting the digital input data and converting it to an analog signal, which in turn, controls the BOP output. The BIT 4886 provides full talk/listen capability and is fully compliant with the SCPI programming language.

At power-up the BIT 4886 is set to local mode, allowing front panel control of the BOP power Supply. Upon power up the BIT 4886 performs a reset, establishing the voltage and current output levels to be 0 volts and the output state to be off.

The BIT 4886 is a 16-bit interface card which allows either plus or minus voltage or current output at 15 bits of resolution.

Table 1-1 shows which specific revisions of BOP models are compatible with BIT 4886 cards.

TABLE 1-1. APPLICABILITY OF BIT 4886 CARDS TO SPECIFIC BOP MODELS

MODEL	REVISION NO.	MODEL	REVISION NO.
BOP 20-5M	2 AND LATER	BOP 50-8M	10 AND LATER
BOP 20-10M	17 AND LATER	BOP 72 3M	10 AND LATER
BOP 20-20M	15 AND LATER	BOP 72-6M	14 AND LATER
BOP 36-6M	19 AND LATER	BOP 100-1M	24 AND LATER
BOP 36-12M	13 AND LATER	BOP 100-2M	15 AND LATER
BOP 50-2M	21 AND LATER	BOP 100-4M	14 AND LATER
BOP 50-4M	13 AND LATER	BOP 200-1M	7 AND LATER

NOTE: For modification (to accept the BIT 4886 card) of BOP Models with revision numbers that do not appear in this table, contact Kepco for assistance.

1.2.1 MEASUREMENTS

The readback information for BIT 4886 cards is the average of the last 16 measurements. The measurement average is valid after a time delay which allows the readings to stabilize, plus 320 milliseconds.

1.2.2 ENHANCED OPERATION

The BIT 4886 card includes the following enhanced operation features: a) advanced control over the way the unit responds to errors (PAR. 4.7.1), b) advanced limit channel control for applications such as battery, photocell, and large inductor applications (see PAR. 4.7.2) and c) ability to save system settings (PAR. 4.7.3).

1.3 SPECIFICATIONS

For voltage and current accuracy specifications of BOP Models with a BIT 4886 card installed, refer to Tables 1-2 and 1-3, respectively. Table 1-4 lists the specifications for the BIT 4886 card.

TABLE 1-2. BOP VOLTAGE SPECIFICATIONS WITH BIT 4886 INSTALLED

VOLTAGE SPECIFICATION	BOP 200-1	BOP 100-1M BOP 100-2M BOP 100-4M	BOP 72-3M BOP 72-6M	BOP 50-2M BOP50-4M BOP 50-8M	BOP 36-6M BOP 36-12	BOP 20-5M BOP20-10M BOP20-20M
High range accuracy	24mV	12mV	8mV	6mV	4mV	2.4mV
Low Range Accuracy	6mV	3mV	2mV	1.5mV	1mV	0.6mV
Positive Limit Accuracy	300mV	150mV	100mV	90mV	75mV	36mV
Measurement Accuracy	120mV	60mV	45mV	30mV	24mV	12mV

NOTE: Low range is defined as less than 1/4 of the rated value.

TABLE 1-3. BOP CURRENT SPECIFICATIONS WITH BIT 4886 INSTALLED

CURRENT SPECIFICATION	BOP MODEL (ARRANGED BY CURRENT CAPABILITY)									
	20-20M	36-12M	20-10M	50-8M	36-6M 72-6M	20-5M	50-4M 100-4M	72-3M	50-2M 100-2M	100-1M 200-1M
High range accuracy	20mA	6mA	5mA	4mA	1.2mA	1mA	0.5mA	0.36mA	0.25mA	0.12mA
Low Range Accuracy	1.6mA	0.5mA	0.3mA	0.25mA	0.2mA	0.15mA	0.12mA	0.08mA	0.06mA	0.03mA
Positive Limit Accuracy	40mA	28mA	24mA	20mA	6mA	5mA	8mA	3mA	2mA	1mA
Measurement Accuracy	20mA	14mA	12mA	5mA	3mA	2.5mA	2mA	1.5mA	1mA	0.5mA

NOTES: 1. Low range is defined as less than 1/4 of the rated value
2. Accuracy specifications apply only after 1 minute warm-up.

TABLE 1-4. SPECIFICATIONS, BIT 4886

SPECIFICATION		DESCRIPTION	
OUTPUT VOLTAGE (MAIN CHANNEL)	High Range	Programs BOP to rated value	
	Low Range	Programs BOP to 1/4 rated value	
	Rise and Fall times (VOLT:MIN to VOLT:MAX)	<100 microseconds	
LIMIT CHANNEL ACCURACY		0.5%	
TEMPERATURE COEFFICIENT		Full scale: ± 35 ppm/ $^{\circ}$ C max Zero: High Range ± 10 ppm/ $^{\circ}$ C max Low Range ± 30 ppm/ $^{\circ}$ C max Voltage Readback: High Range $\pm 20\mu$ V/ $^{\circ}$ C max Low Range $\pm 10\mu$ V/ $^{\circ}$ C max Current Readback: ± 10 ppm/ $^{\circ}$ C max	
OPTICAL ISOLATION		Digital and Analog grounds can be separated by a maximum of 500 Volts.	
DIGITAL INPUT FORMAT		Byte-Serial/IEEE	
POWER REQUIREMENT		Supplied by host power supply	
RESOLUTION	PROGRAMMING	15 bits	
	READBCK	15 bits	
LINEARITY	PROGRAMMING	± 1 LSB	
	READBCK	± 2 LSBs	
PROGRAMMING		ACCURACY (% OF MAX. OUTPUT)	CAPABILITY
	VOLTAGE HIGH RANGE	0.01% of E_{oMAX}	15 Bits
	VOLTAGE LOW RANGE	0.01% of 1/4 E_{oMAX}	15 Bits
	CURRENT HIGH RANGE	0.015% of I_{oMAX} (See Note 1.)	15 Bits
	CURRENT LOW RANGE	0.01% of I_{oMAX}	15 Bits
	LIMIT CHANNEL	0.5% (See Note 2.)	12 Bits
DATA READBCK ACCURACY	VOLTAGE	0.05%	% of Max. Voltage or Current
	CURRENT		
LIST	STEP RANGE	500 microseconds to 10 seconds	
	STEP ACCURACY	-5 TO +20 microseconds (See Note 3.)	
	NUMBER OF STEPS	1002	
	RISE/FALL TIME	>100 microseconds	
TRANSIENT	TRANSIENT RANGE	500 microseconds to 10 seconds	
	TRANSIENT ACCURACY	-20 TO +1200 microseconds (See Note 3.)	
	RISE/FALL TIME	>100 microseconds	
ENVIRONMENTAL SPECIFICATIONS	OPERATING TEMP.	0 to 50 $^{\circ}$ C	
	STORAGE TEMP.	-20 to +85 $^{\circ}$ C	
NOTES: 1. The current control specification (stability) of BOP power supplies is not altered or improved by the addition of a BIT 4886 card. The current stability of the BIT 4886 card with most BOPs will be 0.015%. However, Some BOP models have better control specifications, e.g., the BOP 20-5 (0.006% stability), and others have lower stability such as the BOP 100-4 (0.02%), BOP 50-4 (0.05%) and BOP 20-20 (0.1%). All stability measurements are after warm-up time of 5 minutes. 2. For all BOP models (except 200-1) with BIT 4886 card installed typical voltage mode ripple/noise = 4mV rms, max noise = 6mV rms and 60mV p-p. For BOP 200-1 models typical voltage mode ripple/noise = 4mV rms, maximum voltage mode ripple/noise = 8mV rms and 80mV p-p. 3. Accuracy is affected by GPIB and RS-232 communications. To attain these accuracies only the Serial poll command of the GPIB interface should be used while executing a transient or list.			

1.3.1 BIT 4882 COMPATIBILITY

The BIT 4886 card complies with the SCPI 1997 standard as a member of the power supply instrument class. The Bit 4882 product complies with the 1990 version of the SCPI standard. During the years of 1990 to 1997, the SCPI consortium refined the standard, providing direction for the *RST command and indicating the differences between *RST and the single byte GPIB command of **DCL** and **SDC**. The BIT 4886 card when shipped by KEPCO, is not compatible with user software developed for the BIT 4882. The user can make it more compatible by using the **SYST:SET** command to reconfigure the operation of **DCL**, ***RST** and the sending of data to the host computer. Appendix B, Figure B-8, illustrates the use of the **SYST:SET** command to change the BIT 4886 to operate like the BIT 4882, except for some minor differences that will remain for some 4882 command sequences (see Table 1-5).

TABLE 1-5. COMMAND DIFFERENCES FOR BIT 4886 CARD CONFIGURED AS BIT 4882

Command	BIT Card Behavior	
	BIT 4882	BIT 4886 configured as BIT 4882
VOLT?MAX	Returns 100	No action - error 113
VOLT? MIN	Returns 0	Returns -Eomax (e.g. for BOP 100-1 returns -100)
VOLT10	Set output = 10V	No action - error 113
OUTP OFF;VOLT 10;OUTP ON	Set output = 0	Set output = 10 volts

SECTION 2 - INSTALLATION

2.1 UNPACKING AND INSPECTION

The Interface Card has been thoroughly inspected and tested prior to packing and is ready for operation following installation. Unpack, saving original packing material. If any indication of damage is found, file a claim immediately with the responsible transport service. See Table 2-1 for items supplied.

TABLE 2-1. ITEMS SUPPLIED

ITEM	KEPCO PART NUMBER	QUANTITY
PCB Assembly	236-1836	1
Cable #1	241-0889	1
Cable #2	241-0899	1
Knurled Nut (6-32 x 3/4 DIA. BR., THUMB)	102-0023	3
Washers (#6 EXT. LOCK, STEEL)	103-0046	3
Label, Address	188-1726	1
Label, Control Identification	188-1826	1
Bracket	128-1810	1
Connector (see NOTE)	142-0506	1
Cable (see NOTE)	118-1164	1
NOTE: Item not required for installation; used to connect RS 232 port to an external computer.		

2.2 SET START-UP DEFAULTS (SEE FIGURE 2-1)

The start-up default, consisting of the Device Address (GPIB address) is initially set by means of DIP switches as described in PAR. 2.2.1. The default power supply identification is described in PAR. 2.2.2.

2.2.1 SET (GPIB) DEVICE ADDRESS (SEE FIGURE 2-1)

The Device Address for the interface card is set by means of DIP switch S1, positions 1 through 5 (Figure 2-1). The Device Address is the permanent Listener or Talker address of the interface card on the GPIB. It is factory preset to address 6. If a different Device Address is required in your system, proceed as follows. There are 31 (1-31) possible choices (See Table 2-2).

1. Position the Interface Card as depicted in Figure 2-1.
2. The Device Address DIP switches are positions 1 through 5 (from right to left, Figure 2-1). These switches are preset by Kepco to address 6. For other device addresses set them according to Table 2-2.

2.2.2 POWER SUPPLY IDENTIFICATION

The BIT 4886 interface card is factory set to report power supply voltage as 200 Volts and current as 20 Amperes. The interface card has nonvolatile random access memory which is used to store these values. A special GPIB command of DIAG:PST is used to set the voltage and current of the power supply which has the BIT 4886 card installed. Other commands can be used to establish other operating characteristics such as the language and DCL operation. See Appendix B and PAR. 4.2 for detailed procedures and instructions.

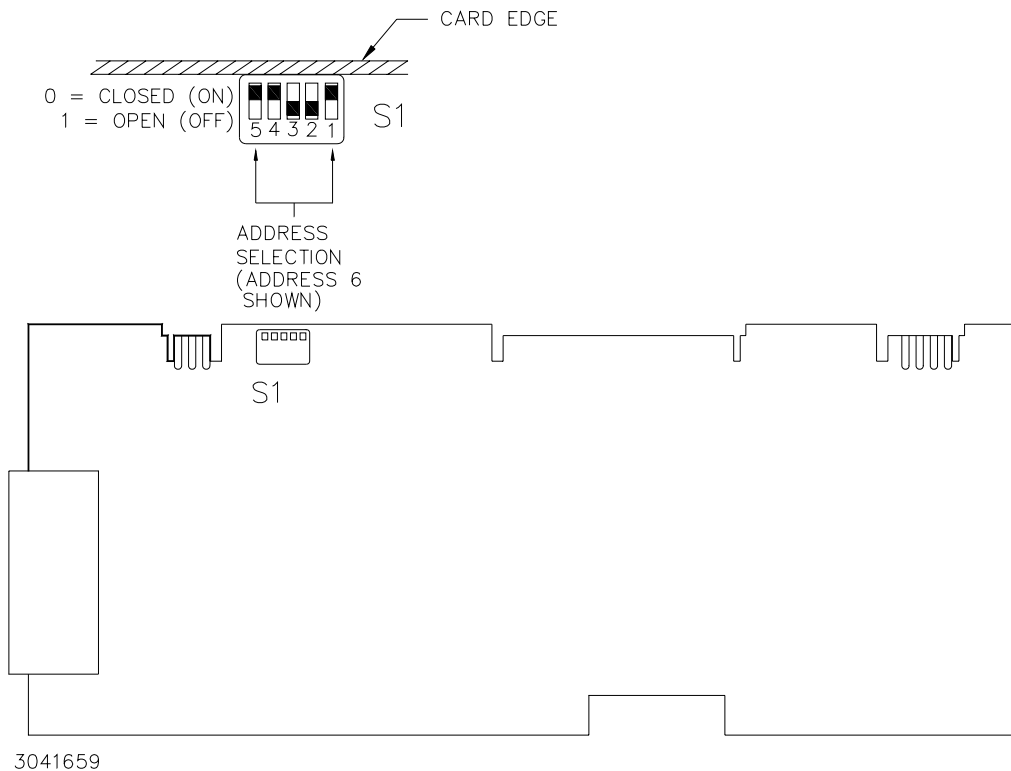

FIGURE 2-1. BIT 4886 SWITCH LOCATIONS

TABLE 2-2. DEVICE ADDRESS SELECTION

DECIMAL ADDRESS	SELECTOR SWITCH S1 SECTION (SIGNAL LINE)				
	A5	A4	A3	A2	A1
1	0	0	0	0	1
2	0	0	0	1	0
3	0	0	0	1	1
4	0	0	1	0	0
5	0	0	1	0	1
6	0	0	1	1	0
7	0	0	1	1	1
8	0	1	0	0	0
9	0	1	0	0	1
10	0	1	0	1	0
11	0	1	0	1	1
12	0	1	1	0	0
13	0	1	1	0	1
14	0	1	1	1	0
15	0	1	1	1	1
16	1	0	0	0	0
17	1	0	0	0	1
18	1	0	0	1	0
19	1	0	0	1	1
20	1	0	1	0	0
21	1	0	1	0	1
22	1	0	1	1	0
23	1	0	1	1	1
24	1	1	0	0	0
25	1	1	0	0	1
26	1	1	0	1	0
27	1	1	0	1	1
28	1	1	1	0	0
29	1	1	1	0	1
30	1	1	1	1	0
31	1	1	1	1	1

NOTE: 0 = CLOSED (ON) (Towards printed circuit board)
1 = OPEN (OFF) (Away from printed circuit board)

2.3 INSTALLATION OF INTERFACE CARD INTO THE BOP

Refer to Figure 2-2 to install the BIT 4886 interface card.

CAUTION: The BIT 4886 card contains ESD sensitive components. Follow all procedures in effect at your facility for handling ESD sensitive components.

NOTE: Step numbers coincide with encircled numbers on Figure 2-2.

- Step 1. Remove a-c power to BOP by disconnecting line cord.
- Step 2. Remove BOP cover (see Section 5, Figure 5-1 of your BOP Instruction Manual).
- Step 3. Remove and discard Rear Cover Plate (PN 128-1566) and associated hardware.
- Step 4. Remove J204 Connector Assembly (PN 241-0680) from Location #1, save for Step 8.
- Step 5. Locate Transformer T202 and unplug connector from Location #4 only.
- Step 6. Locate Rear Bracket and note part number (stamped on outside left edge):
 - if PN 128-1810 proceed to Step 7.
 - if not PN 128-1810, stop installation. Unit does not meet minimum requirements; contact Kepco for assistance.
- Step 7. Unpack the BIT 4886 Interface Card Installation Components (PCB Assembly, Cables #1 and #2, Connector Assembly, three (3) Knurled Nuts, five (5) washers, Spacer and Bracket).
- Step 8. Install BIT 4886 Interface Card into the guides, slide into position so that mounting holes in PCB Assembly line up with the two mounting posts on the BOP mounting bracket.
- Step 9. Secure the BIT 4886 Interface Card to the Mounting Posts using the Knurled Nuts and Lockwashers. Mount Connector J204 (Ref. Step 4, above) into Location #3 using the Lockwashers, Hex Spacer and knurled nut.
- Step 10. Install Cable #1 (18-position connectors) to the BIT 4886 Interface Card, mate the other end of the cable with Location #1 on BOP A1 Assembly.
- Step 11. Install Cable #2 (5-position connectors) to the BIT 4886 Interface Card, mate the other end of the cable with Location #2 on BOP A1 Assembly.
- Step 12. Plug in 3-pin Connector from Transformer 100-2354 (removed in step 5) into BIT 4886 Card, Location #5.
- Step 13. Mark "-4886" after Model No. on Nameplate (see Detail A).
- Step 14. On BOP cover, peel off "Address Label" (PN 188-1012). Affix revised "Address Label" (PN 188-1726) in vacated position (with part number facing front panel).
- Step 15. Initialize the GPIB per PAR. 4.2, then proceed to step 16.
- Step 16. Perform calibration procedure detailed in Section 3 of this manual.
- Step 17. Reinstall BOP cover.

2.4 INPUT/OUTPUT SIGNALS

The IEEE 488 port is a 24 pin IEEE 488 connector (Figure 2-3) and conforms mechanically and electrically to the IEEE 488 standard; refer to Table 2-3 for pin assignments. Table 2-4 describes the RS 232 port pin connections.

TABLE 2-3. INPUT/OUTPUT PIN ASSIGNMENTS

PIN	SIGNAL NAME	FUNCTION
1	DI01	I/O Line
2	DI02	I/O Line
3	DI03	I/O Line
4	DI04	I/O Line
5	EOI	End or Identify
6	DAV	Data Valid
7	NRFD	Not Ready for Data
8	NDAC	Not Data Accepted
9	IFC	Interface Clear
10	SRQ	Service Request
11	ATN	Attention
12	SHIELD	Shield
13	DI05	I/O Line
14	DI06	I/O Line
15	DI07	I/O Line
16	DI08	I/O Line
17	REN	Remote Enable
18	GND	Ground (signal common)
19	GND	Ground (signal common)
20	GND	Ground (signal common)
21	GND	Ground (signal common)
22	GND	Ground (signal common)
23	GND	Ground (signal common)
24	LOGIC GND	Logic Ground

IEEE 488 BUS (GPIB) 24 PIN RECEPTACLE

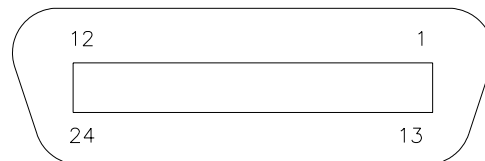

3041133

FIGURE 2-3. IEEE 488 (GPIB) CONNECTOR

TABLE 2-4. RS232C PORT INPUT/OUTPUT PIN ASSIGNMENTS

CONNECTOR	PIN	SIGNAL NAME	FUNCTION
RS 232 PORT	1	RTS	Request To Send (protocol not used)
	2	RXD	Receive Data
	3	TXD	Transmit Data
	4	LOGIC GND	Logic Ground
	5	LOGIC GND	Logic Ground
	6	CTS	Clear To Send (protocol not used)

TABLE 2-5. RJ45 TO DB9 ADAPTER WIRE FUNCTIONS

Wire	DB9 Pin	Purpose
Green	5	Return for pins 2 and 3.
Brown	3	Carries data from the Kepco power supply to the controller.
Yellow	2	Carries data from the controller to the Kepco power supply.

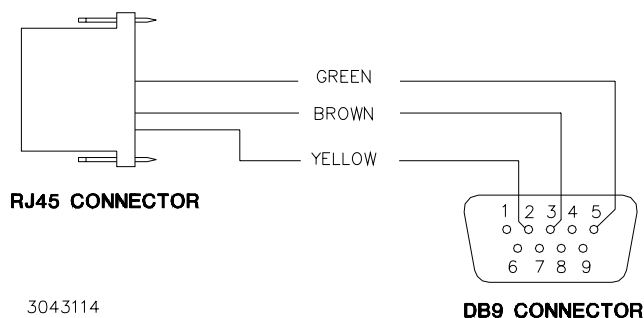

3043114

FIGURE 2-4. RJ45 TO DB9 ADAPTER WIRING

2.5 INITIAL CHECK-OUT PROCEDURE

After the BIT 4886 card has been installed per PAR. 2.3, perform the following procedure to verify that it is functioning properly.

1. Connect the BOP-BIT 4886 Interface Card to either:
 - a) the GPIB bus using a standard GPIB cable connected to the BIT 4886 24-pin GPIB connector (J1) or
 - b) to an external RS-232 controller with a DB9 type connector (male pins) by connecting the RJ45 patch cord supplied (see Table 2-1) to the BIT 4886 RS 232 port (J2), then using the RJ45 to DB9 adapter supplied (see Table 2-1) to connect the RJ45 patch cord to the external controller. On the RJ45 patch cord, the 6-pin connector plugs into the BIT 4886 RS 232 port, and the 8-pin connector plugs into the RJ45 to DB9 adapter (see Table 2-5 and Figure 2-4).
2. Apply power to BOP power supply. The BOP-BIT 4886 will beep for less than 1 second, then will be ready for use.

3. Send the ***IDN?** query via either the GPIB or RS 232 port.

Assuming the BIT 4886 card is installed in a BOP 72-6 as an example, verify that the unit responds with **KEPCO,BIT488-6 72-6,A38621 11/10/98,1.81-1.81**.

If the unit responds with **KEPCO,BIT488-6 200-20,A38621 10/01/98,1.81-1.81**, it means that the card was not initialized (see PAR. 4.2).

Note that date **10/01/98** is the initial calibration date performed at the factory and indicates the card has never been calibrated by the user.

4. Send **VOLT?** Verify that unit responds with **0** (indicating voltage is set to 0, the power-up condition).
5. Send **OUTPUT ON;VOLT MAX**. Verify that the BOP power supply provides maximum output voltage (e.g., 72V d-c. for BOP 72-6).
6. Send **FUNC:MODE CURR**. Verify that BOP front panel current LED lights.
7. Send **FUNC:MODE VOLT**. Verify that BOP front panel voltage LED lights.

SECTION 3 - CALIBRATION

NOTE: The calibration procedures below are for the purpose of recalibration and for the case where the BIT card is installed by the user. Unless otherwise noted, syntax is in SCPI.

3.1 EQUIPMENT REQUIRED

The following is a listing of equipment required for calibration of the Interface Card installed in a Kepco "BOP" Series Power Supply:

- A. Precision digital voltmeter (DVM), minimum resolution 7 digits (suggested):
- B. An IEEE 488 System Controller, (with appropriate software) connected to BOP Power Supply with an IEEE 488 cable.
- C. Precision four-terminal current shunt (sense resistor) with suitable power rating and tolerance for the currents to be measured.
- D. Heat sink, capable of dissipating 10 times power rating of sense resistor

3.2 BOP POWER SUPPLY ADJUSTMENTS

3.2.1 ADJUSTMENT OF THE BOP ± 10 VOLT CALIBRATION CONTROLS (R31, R32)

NOTE: BOP cover removal required for this step.

1. Connect the DVM to the REAR PROGRAMMING CONNECTOR (PC-12) between common and pin 28 (+10Vdc REFERENCE).
2. Turn the BOP Power Supply "ON" and locate the calibration controls (see Figure 3-1). Adjust R31 for $+10.00 \pm 0.01$ Vdc.
3. Turn the BOP Power Supply "OFF" and connect DVM between common and pin 22 (-10Vdc REFERENCE) at the REAR PROGRAMMING CONNECTOR (PC 12).
4. Turn the BOP Power Supply "ON." Adjust R32 for -10.00 ± 0.01 Vdc.
5. Turn the BOP Power Supply "OFF."

3.2.2 ADJUSTMENT OF THE AMMETER ZERO (R50)

1. Without a load connected to the BOP output, connect the DVM to the REAR PROGRAMMING CONNECTOR (PC-12); between COMMON and pin 10.
2. Turn the BOP Power Supply "ON" and locate AMMETER ZERO control R50 (see Figure 3-1).
3. Adjust the AMMETER ZERO control R50 for zero, ± 100 microvolts.
4. Turn the BOP Power Supply "OFF."

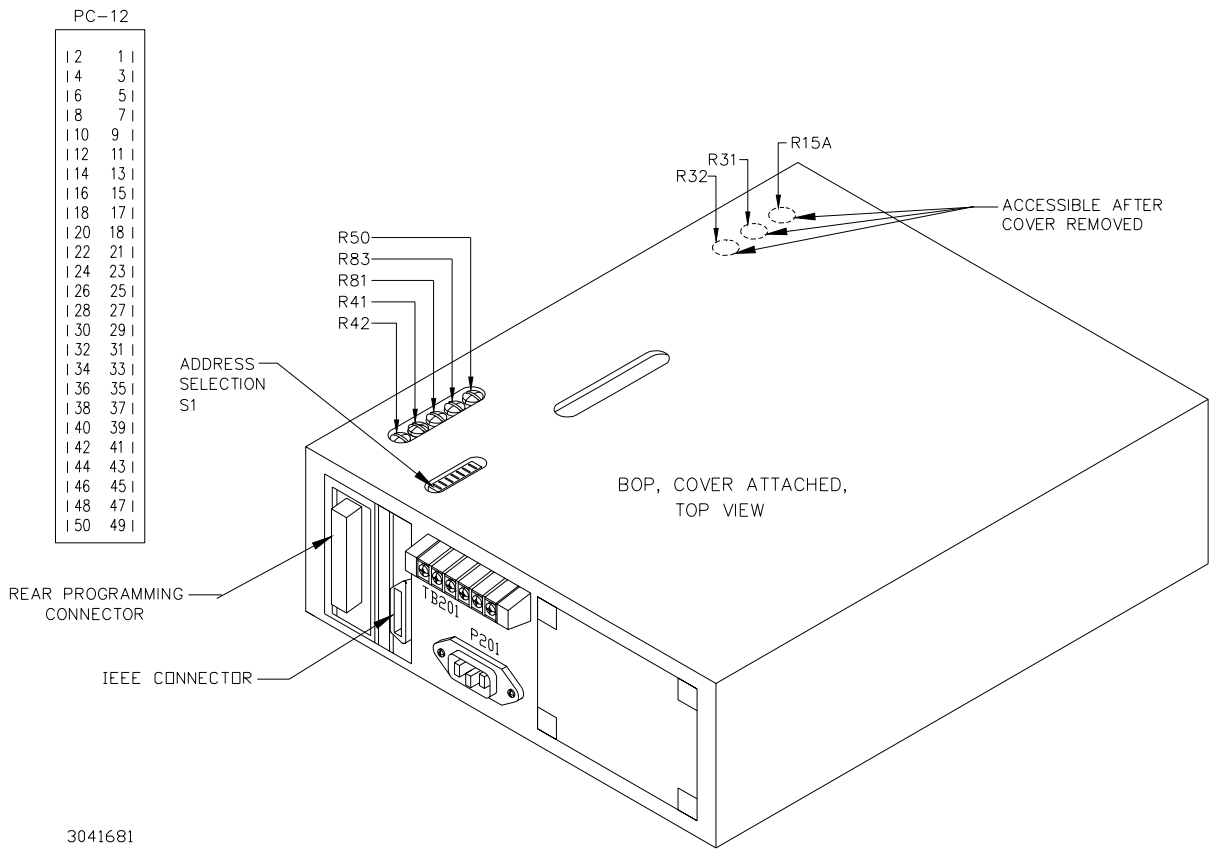

FIGURE 3-1. BOP POWER SUPPLY, INTERNAL CALIBRATION CONTROL LOCATIONS

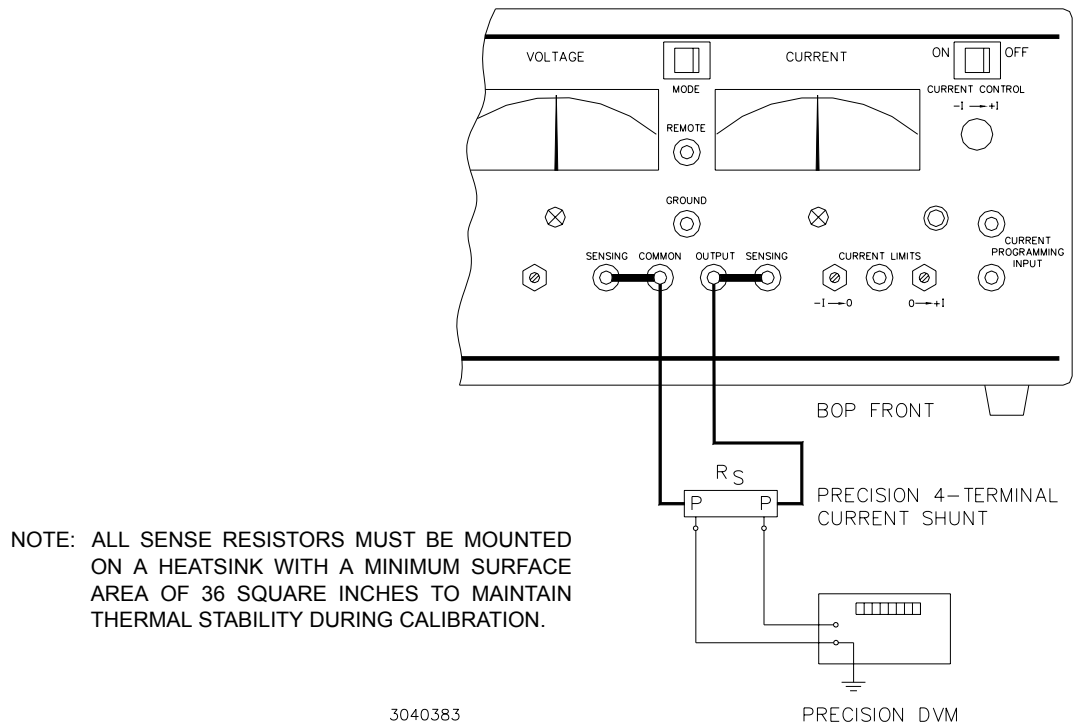

FIGURE 3-2. CURRENT SHUNT CONNECTIONS

3.3 CALIBRATION OF BIT 4886 INTERFACE CARD

Calibration of the BIT 4886 card is performed using SCPI commands. The Instrument driver available at www.kepcopower.com/drivers.htm provides a graphical interface with informational displays and prompts which lead you through the calibration of the BIT 4886 card. This VISA compliant driver works with many GPIB cards from suppliers like National Instruments and Hewlett-Packard.

Calibration using the graphical interface is described in PAR. 3.3.2; as an alternative to the graphical interface, the BIT 4886 card can also be calibrated using the manual procedure described in PAR. 3.3.1.

NOTE: During calibration various circuits of the BIT 4886 Interface Card are verified. If an error occurs during the verification process, the interface card will beep and an error 240, Hardware, will be placed in the error queue.

The calibration values for different BOP Models are defined in Tables 3-1 and 3-2 for voltage and current, respectively. For each step requiring a measurement during calibration the tolerance of the measurements are included in Tables 3-1 and 3-2 and are not repeated in the individual steps.

Table 3-3 lists suggested sense resistors and includes Kepco and Manufacturer's part numbers. The accuracy of these resistors is 0.1% and will result in a system accuracy of 0.11% if the listed values in Tables 3-1 and 3-2 are used. **For a system accuracy of 0.01%, measure the actual value of the sense resistor accurate to 7 places. Then calculate the expected values per Table 3-2 notes A-E; use with the listed tolerances of Table 3-2 to perform the calibration.**

TABLE 3-1. CALIBRATION MEASUREMENTS AND TOLERANCES - VOLTAGE

MODEL	LOW RANGE ZERO	VOLT ZERO	MAX OUTPUT	HIGH RANGE ACCURACY	LOW RANGE ACCURACY	LOW RANGE NOMINAL	VOLTAGE LIMIT ADJUST
	PAR. 3.3.1 STEP 2	PAR. 3.3.1 STEP 3	PAR. 3.3.1 STEPS 4, 5	PAR. 3.3.1 STEPS 6, 8	PAR. 3.3.1 STEPS 11, 13	PAR. 3.3.1 STEP 10	PAR. 3.3.1 STEP 15
	PAR. 3.3.2 STEP 4	PAR. 3.3.2 STEP 5	N/A	PAR. 3.3.2 STEPS 6, 7	PAR. 3.3.2 STEPS 8, 9	N/A	PAR. 3.3.2 STEP 3
BOP 20-5M BOP 20-10M BOP 20-20M	0V ±0.0003V	0V ±0.0003V	20V	20.0015V (MAX) -20.0015V (MIN) ±0.0015V	5.0003V (MAX) -5.0003V (MIN) ±0.0003V	5V	+20.0035V ±0.0035V
BOP 36-6M BOP 36-12M	0V ±0.0004V	0V ±0.0004V	36V	36.0027V (MAX) -36.0027V (MIN) ±0.0027	9.0006V (MAX) -9.0006V (MIN) ±0.0006	9V	+36.005V ±0.005V
BOP 50-2M BOP 50-4 BOP 50-8	0V ±0.0005V	0V ±0.0005V	50V	50.0035V (MAX) -50.0035V (MIN) ±0.0035	12.5009V (MAX) -12.5009V (MIN) ±0.0009	12.5V	+50.007V ±0.007V
BOP 72-3M BOP 72-6M	0V ±0.001V	0V ±0.001V	72V	72.005V (MAX) -72.005V (MIN) ±0.005	18.0014V (MAX) -18.0014V (MIN) ±0.0014	18V	+72.0095V ±0.0095V
BOP 100-1M BOP 100-2M BOP 100-4M	0V ±0.001V	0V ±0.001V	100V	100.0075V (MAX) -100.0075V (MIN) ±0.0075	25.002V (MAX) -25.002V (MIN) ±0.002	25V	+100.0125V ±0.0125V
BOP 200-1M	0V ±0.002V	0V ±0.002V	200V	200.01V (MAX) -200.01V (MIN) ±0.01	50.004V (MAX) -50.004V (MIN) ±0.004	50V	+200.025V ±0.025V

TABLE 3-2. CALIBRATION MEASUREMENTS AND TOLERANCES - CURRENT

MODEL	SENSE RESISTOR VALUE (SEE NOTE AND TABLE 3-3)	LOW CURRENT ZERO	MAIN CURRENT ZERO	MAIN CURRENT NOMINAL	HIGH CURRENT ACCURACY	LOW CURRENT NOMINAL	LOW CURRENT ACCURACY	CURRENT LIMIT ADJUST
		PAR. 3.3.1 STEP 17	PAR. 3.3.1 STEP 18	PAR. 3.3.1 STEPS 19, 20	PAR. 3.3.1 STEPS 21, 23	PAR. 3.3.1 STEP 24, 25	PAR. 3.3.1 STEPS 26, 28	PAR. 3.3.1 STEP 30
		PAR. 3.3.2 STEP 15	PAR. 3.3.2 STEP 18	N/A	PAR. 3.3.2 STEPS 19, 20	N/A	PAR. 3.3.2 STEPS 16, 17	PAR. 3.3.2 STEP 15
BOP 100-1M BOP 200-1M	1 Ohm	0V ±0.000025V	0V ±0.00005V	1V	1.000075V (MAX) -1.000075V (MIN) ±0.000075V	0.25V	0.25005V (MAX) -0.25005V (MIN) ±0.00005V	1.0013V ±0.0013V
BOP 50-2M BOP 100-2M	1 Ohm	0V ±0.00005V	0V ±0.0001V	2V	2.00015V (MAX) -2.00015V (MIN) ±0.00015V	0.5V	0.5001V (MAX) -0.5001V (MIN) ±0.0001V	2.00026V ±0.00026V
BOP 72-3M	1 Ohm	0V ±0.000075V	0V ±0.00015V	3V	3.0003V (MAX) -3.0003V (MIN) ±0.0003V	0.75V	0.75015V (MAX) -0.75015V (MIN) ±0.00015V	3.0039V ±0.0039V
BOP 50-4 BOP 100-4M	1 Ohm	0V ±0.0001V	0V ±0.0002V	4V	4.0004V (MAX) -4.0004V (MIN) ±0.0004V	1V	1.0002V (MAX) -1.0002V (MIN) ±0.0002V	4.0007V ±0.0007V
BOP 20-5M	0.1 Ohm	0V ±0.0000125V	0V ±0.000025V	0.5V	0.5000375V (MAX) -0.5000375V (MIN) ±0.0000375V	0.125V	0.125025V (MAX) -0.125025V (MIN) ±0.000025V	0.50065V ±0.00065V
BOP 36-6M BOP 72-6M	0.1 Ohm	0V ±0.000015V	0V ±0.00003V	0.6V	0.600045V (MAX) -0.600045V (MIN) ±0.0000225V	0.15V	0.15003V (MAX) -0.15003V (MIN) ±0.00003V	0.60075V ±0.00075V
BOP 50-8	0.1 Ohm	0V ±0.00002V	0V ±0.00004V	0.8V	0.80006V (MAX) -0.80006V (MIN) ±0.00006V	0.2V	0.20004V (MAX) -0.20004V (MIN) ±0.00004V	0.80105V ±0.000105V
BOP 20-10M	0.1 Ohm	0V ±0.000025V	0V ±0.00005V	1.0V	1.000075V (MAX) -1.000075V (MIN) ±0.000075V	0.25V	0.25005V (MAX) -0.25005V (MIN) ±0.00005V	1.00013V ±0.00013V
BOP 36-12M	0.01 Ohm	0V ±0.000003V	0V ±0.000006V	0.12V	1.020009V (MAX) -1.020009V (MIN) ±0.000009V	0.03V	0.030006V (MAX) -0.030006V (MIN) ±0.000006V	0.120016V ±0.000016V

TABLE 3-2. CALIBRATION MEASUREMENTS AND TOLERANCES - CURRENT (CONTINUED)

MODEL	SENSE RESISTOR VALUE (SEE NOTE AND TABLE 3-3)	LOW CURRENT ZERO	MAIN CURRENT ZERO	MAIN CURRENT NOMINAL	HIGH CURRENT ACCURACY	LOW CURRENT NOMINAL	LOW CURRENT ACCURACY	CURRENT LIMIT ADJUST
		PAR. 3.3.1 STEP 17	PAR. 3.3.1 STEP 18	PAR. 3.3.1 STEPS 19, 20	PAR. 3.3.1 STEPS 21, 23	PAR. 3.3.1 STEP 24, 25	PAR. 3.3.1 STEPS 26, 28	PAR. 3.3.1 STEP 30
		PAR. 3.3.2 STEP 15	PAR. 3.3.2 STEP 18	N/A	PAR. 3.3.2 STEPS 19, 20	N/A	PAR. 3.3.2 STEPS 16, 17	PAR. 3.3.2 STEP 15
BOP 20-20M	0.001 Ohm	0V ±0.00000005V	0V ±0.0000001V	0.02V	0.02000015V (MAX) -0.02000015V (MIN) ±0.00000015V	0.005V	0.0050001V (MAX) -0.0050001V (MIN) ±0.0000001V	0.0200025V ±0.0000025V
REFER TO NOTES IF EXACT SENSE RESISTOR VALUE IS KNOWN.	R _{SENSE} SEE NOTE.	SEE NOTE A.	SEE NOTE B.	SEE NOTE C.	SEE NOTES C AND D	SEE NOTE E.	SEE NOTES E AND B.	SEE NOTE F.
USE SPACE PROVIDED AT RIGHT FOR CALCULATED VALUES.								

NOTES: The following formulas are used to calculate proper calibration values if the exact Sense Resistor value is known.

R_{SENSE} = the measured value of the sense resistor to 6 places (minimum).

I = Rated current output of BOP (e.g., for BOP 50-4M, I = 4)

A. (R_{SENSE}) (I/4) (0.00005)

B. (R_{SENSE}) (I/4) (0.0001) [FOR MODELS WHERE I = 3 OR 4 USE (R_{SENSE}) (I/4) (0.00015)]

C. (R_{SENSE}) (I)

D. (R_{SENSE}) (I) (0.00075) [FOR MODELS WHERE I = 3 OR 4 USE (R_{SENSE}) (I) (0.00012)]

E. (R_{SENSE}) (I/4)

F. [(R_{SENSE}) (I_{omax})]/3800

TABLE 3-3. SUGGESTED SENSE RESISTORS

FOR BOP WITH RATED CURRENT	USE SENSE RESISTOR VALUE	KEPCO PART NO.	MANUFACTURER	MANUFACTURER PART NO.
20A	0.001 OHM, 30W	KT 3126	ISOTEK	RTO-B-R1-1
12A	0.01 OHM, 30W	KT 3130	ISOTEK	RTO-B-R01-1
5A, 6A, 8A, 10A	0.1 OHM, 30W	KT 3131	ISOTEK	RTO-B-R001-1
1A, 2A, 3A, 4A	1 OHM, 30W	KT 3146	ISOTEK	RTO-B-1R00-1.0

NOTE: ALL SENSE RESISTORS MUST BE MOUNTED ON A HEATSINK WITH A MINIMUM SURFACE AREA OF 36 SQUARE INCHES TO MAINTAIN THERMAL STABILITY DURING CALIBRATION (KEPCO P/N 136-0451 RECOMMENDED FOR KT SENSE RESISTORS LISTED).

3.3.1 MANUAL CALIBRATION

1. Initiate calibration by sending the SCPI command **SYSTEM:PASSWORD:CENable DEFAULT** and then send **CAL:STATE 1**. The password (DEFAULT) has been set at the factory. If the password has been changed from DEFAULT, substitute the correct password for the unit in the **SYST:PASS:CEN** command. If the password has been forgotten, consult factory.

If voltage calibration is not needed, proceed to step 16 for current calibration.

2. Set the BOP to zero volts output under the 1/4 range by sending **CAL:LVOLT ZERO**. Connect a Digital Voltmeter (DVM) to the BOP output to measure the power supply output. Send the Command **CAL:DPOT 32** to increase the output voltage until the DVM no longer changes in response to the command. Then send the Command **CAL:DPOT -32** to the unit. Adjust A1R81 on BOP until the DVM reads the voltage specified in Table 3-1 for LOW RANGE ZERO.
3. Set the BOP output voltage to zero by sending **CAL:VOLT ZERO**. Send the command **CAL:DPOT 1** to increase the voltage or **CAL:DPOT -1** to decrease the voltage until the DVM reads the voltage specified in Table 3-1 for VOLT ZERO.
4. Set the BOP to maximum positive output voltage by sending **CAL:VOLT MAX**. Measure the voltage output using a DVM of at least 7 digits in accuracy.
5. Decrease the voltage output by sending **CAL:DPOT -1** commands until the voltmeter reads less than the rated output voltage specified in Table 3-1 for MAX OUTPUT. Then send **CAL:DPOT 1** and verify the voltage is slightly above the rated output voltage specified in Table 3-1 for MAX OUTPUT
6. Referring to Table 3-1 (HIGH RANGE ACCURACY) for value and \pm tolerance, send the command **CAL:DATA -10** to decrease the voltage until the voltage is less than the rated output. Send the command **CAL:DATA 1** to increase the voltage or the command **CAL:DATA -1** to decrease the voltage until the DVM reads the value specified in Table 3-1 for HIGH RANGE ACCURACY MAX.
7. Set the BOP to maximum negative output by sending **CAL:VOLT MIN**. Continue to measure the output of the supply using the DVM.
8. If the output is less negative than the value specified in Table 3-1 for HIGH RANGE ACCURACY MIN, send **CAL:DATA -100** and verify the output is now more negative. If the value is still not more negative, send **CAL:DPOT -1** to change the course adjustment and provide a more negative output.

Send the command **CAL:DATA 10** to increase the voltage. Continue to send **CAL:DATA 10** until the voltage is less negative than the value specified in Table 3-1 for HIGH RANGE ACCURACY MIN. Send **CAL:DATA -1** until the reading is within the limits specified in Table 3-1 for HIGH RANGE ACCURACY MIN.

If the **CAL:DPOT** command was used to adjust the negative output, send **CAL:VOLT MAX** to the unit and repeat step 6 before proceeding to step 9.

9. Set the BOP to 1/4 scale (low) range positive output voltage by sending **CAL:LVOLT MAX**. Output voltage should be as specified in Table 3-1 for LOW RANGE NOMINAL. Measure the voltage output using a Digital Voltmeter of at least 7 digits in accuracy.

10. Decrease the voltage output by sending **CAL:DPOT -1** commands until the voltmeter reads less than the rated output. Then send **CAL:DPOT 1** and verify the voltage is slightly above value specified in Table 3-1 for LOW RANGE NOMINAL.
11. Send the command **CAL:DATA -10** to decrease the voltage until the voltage is less than value specified in Table 3-1 for LOW RANGE ACCURACY MAX. Send the command **CAL:DATA 1** to increase the voltage or the command **CAL:DATA -1** to decrease the voltage to obtain the value specified in Table 3-1 for LOW RANGE ACCURACY MAX.
12. Set the BOP to maximum negative 1/4 scale range output by sending **CAL:LVOLT MIN**. Continue to measure the output of the supply.
13. If the output is less negative than the value specified in Table 3-1 for LOW RANGE ACCURACY MIN, send **CAL:DATA -100** and verify the output is now more negative. If the value is not more negative, Send **CAL:DPOT -1** to change the course adjustment and provide a more negative output.

Send the command **CAL:DATA 10** to increase the voltage. Continue to send **CAL:DATA 10** until the voltage is less negative than the value specified in Table 3-1 for LOW RANGE ACCURACY MIN. Send **CAL:DATA -1** until the reading is within the limits specified in Table 3-1 for LOW RANGE ACCURACY MIN.

If the **CAL:DPOT** command was used to adjust the negative output, send **CAL:LVOLT MAX** to the unit and repeat step 11 before proceeding to step 14.

14. Set the BOP to voltage limit by sending **CAL:VPR MAX**. Continue to measure the output of the BOP.
15. Send the command **CAL:DATA -10** to decrease the voltage until the output voltage measured is within, or close to, the tolerance specified in Table 3-1 for VOLTAGE LIMIT ADJUST. Send the command **CAL:DATA 1** to increase the voltage or **CAL:DATA -1** to decrease the voltage as necessary until the measured value is within the tolerance specified in Table 3-1 for VOLTAGE LIMIT ADJUST.

NOTE: If Current calibration is not required, proceed to step 31.

16. Send **CAL:ZERO** to prepare for current calibration. After sending the command, the BOP output will be set to zero volts. Connect the Kelvin type sense resistor to the BOP output using a heat sink capable of dissipating 10 times rated power of sense resistor. Connect the DVM to the sensing terminals of the Kelvin type sense resistor as shown in Figure 3-2. Table 3-2 provides suggested sense resistor values for various BOP current outputs, as well as the formula for calculating expected measured values and tolerances for any sense resistor where the precise resistance is known. Table 3-3 lists possible sources for obtaining the suggested sense resistors
17. Set the BOP to zero volts across the sense resistor (corresponding to zero current) under the low (1/4 Scale) current range by sending **CAL:LCURR ZERO**. Monitor the DVM connected to the sense resistor and send the command **CAL:DPOT 64** to increase the output voltage and **CAL:DPOT -32** to set the digital pot to the center of its range. Adjust A1R83 on BOP until the DVM reads the voltage specified in Table 3-2 for LOW CURRENT ZERO.
18. Set the BOP current to 0 Amps in current mode by sending **CAL:CURR ZERO**. Use the command **CAL:DPOT 1** to increase the current or **CAL:DPOT -1** to decrease the current until the DVM reads the voltage specified in Table 3-2 for MAIN CURRENT ZERO.

19. Set the BOP to maximum positive output current by sending **CAL:CURR MAX**. Measure the voltage across the sense resistor using a Digital Voltmeter of at least 7 digits in accuracy. Verify the DVM reads the voltage specified in Table 3-2 for MAIN CURRENT NOMINAL. The voltage shown on the DVM should be positive; if not, reverse the leads to the DVM.
20. Decrease the voltage across the sense resistor by sending **CAL:DPOT -1** commands until the voltmeter reads less than the value specified in Table 3-2 for MAIN CURRENT NOMINAL. Then send **CAL:DPOT 1** and verify the voltage is slightly above the specified voltage.
21. Send the command **CAL:DATA -10** to decrease the voltage across the sense resistor until the voltage is less than the value specified in Table 3-2 for HIGH CURRENT ACCURACY MAX. Send the command **CAL:DATA 1** to increase the voltage or **CAL:DATA -1** to decrease the voltage until the DVM reads the voltage specified in Table 3-2 for HIGH CURRENT ACCURACY MAX.
22. Set the BOP to maximum negative output by sending **CAL:CURR MIN**. Continue to measure the voltage across the sense resistor.
23. If the voltage across the sense resistor is less negative than the value specified in Table 3-2 for HIGH CURRENT ACCURACY MIN, send **CAL:DATA -100** and verify the output is now more negative. If the value is not more negative than the value found in Table 3-2 for HIGH CURRENT ACCURACY MIN, send **CAL:DPOT -1** to change the course adjustment and provide a more negative output.

Send the command **CAL:DATA 10** to increase the voltage across the sense resistor. Continue to send **CAL:DATA 10** until the voltage is less than the value specified in Table 3-2 for HIGH CURRENT ACCURACY MIN. Send **CAL:DATA -1** until the DVM reads the voltage specified in Table 3-2 for HIGH CURRENT ACCURACY MIN.

If the **CAL:DPOT** command was used to adjust the negative output, send **CAL:CURR MAX** to the unit and repeat step 21 before proceeding to step 24.

24. Set BOP to the maximum current at low range (1/4 Scale) by sending **CAL:LCURR MAX**. Verify the DVM reads the voltage specified in Table 3-2 for LOW CURRENT NOMINAL.
25. Decrease the voltage across the sense resistor by sending **CAL:DPOT -1** commands until the voltmeter reads less than the value specified in Table 3-2 for LOW CURRENT NOMINAL. Then send **CAL:DPOT 1** and verify the voltage is slightly above this value.
26. Send the command **CAL:DATA -10** to decrease the voltage across the sense resistor until the voltage is less than the value specified in Table 3-2 for LOW RANGE ACCURACY MAX. If necessary, send the command **CAL:DATA 1** to increase the voltage across the sense resistor or **CAL:DATA -1** to decrease the voltage across the sense resistor until the DVM reads the voltage specified in Table 3-2 for LOW RANGE ACCURACY MAX.
27. Set the BOP to maximum negative 1/4 scale range output current by sending **CAL:LCURR MIN**. Continue to measure the voltage across the sense resistor.
28. If the voltage across the sense resistor is less negative than the value specified in Table 3-2 for LOW RANGE ACCURACY MIN, send **CAL:DATA -100** and verify the output is now more negative. If the value is not more negative, Send **CAL:DPOT -1** to change the course adjustment and provide a more negative output.

Send the command **CAL:DATA 10** to increase the voltage across the sense resistor. Continue to send **CAL:DATA 10** until the voltage is less than the value specified in Table 3-2 for LOW RANGE ACCURACY MIN. Send **CAL:DATA -1** until the reading is within the limits specified in Table 3-2 for LOW RANGE ACCURACY MIN.

If the `CAL:DPOT` command was used to adjust the negative output, after adjusting the negative supply output, send `CAL:LCURR MAX` to the unit and repeat step 26 before proceeding to step 29.

29. Set the BOP to current limit by sending `CAL:CPR MAX`. Continue to measure the output of the BOP.
30. Send the command `CAL:DATA -10` to decrease the voltage across the sense resistor until the output voltage measured is within, or close to, the tolerance specified in Table 3-2 for CURRENT LIMIT ADJUST. Send the command `CAL:DATA 1` to increase the voltage or `CAL:DATA -1` to decrease the voltage as necessary until the measured value is within the tolerance specified in Table 3-1 for CURRENT LIMIT ADJUST.
31. Save the calibration levels by sending `CAL:SAVE 2/21/2004`. The 9 characters at the end are optional and are the calibration date of the power supply. The date entered in this manner is reported in the `*idn?` query. This can be prove useful for checking calibration dates when periodic calibration is imposed by system or quality requirements.

3.3.2 CALIBRATION OF BIT 4886 INTERFACE CARD USING THE VISA DRIVER SOFT PANEL

Calibration of the BIT 4886 card installed in the BOP is performed using SCPI commands implemented through the Instrument driver. The driver provides a graphical interface with informational displays and prompts which lead you through the calibration of the BIT 4886 card. This VISA compliant driver works with many GPIB cards from suppliers like National Instruments and Hewlett-Packard.

NOTE: PC-12 connector (See Figure 2-2) must be installed for BOP to function.

The following calibration procedure uses the “soft” front panel which is part of the CVI driver for the BIT 4886 which can be downloaded from the Kepeco website at:

www.kepecopower.com/drivers.htm

Unzip the files and doubleclick on setup.exe to install the driver. The bit_mdac folder will be added to the Start - Programs folder. Doubleclick bit_mdac.exe to run the program, and refer to the visamdac.pdf in the bit_mdac folder for details about using the soft front panel.

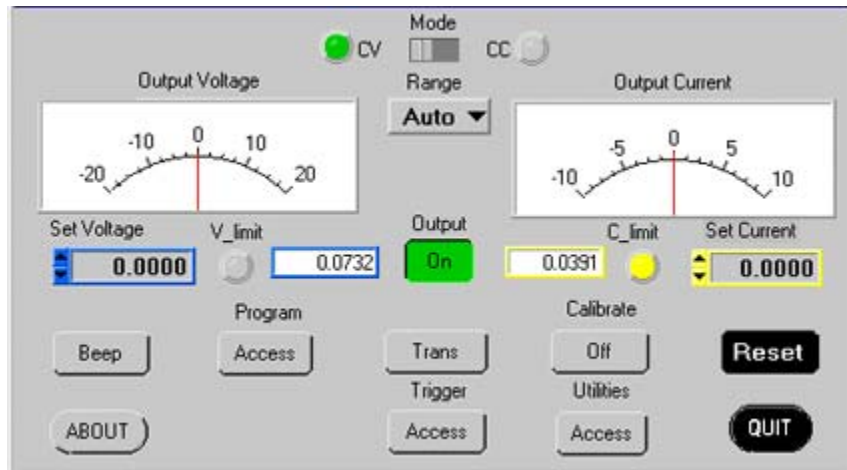

FIGURE 3-3. MAIN PANEL

3.3.2.1 CALIBRATION BASICS

CAUTION: Before performing calibration, set BOP OUTPUT to OFF and connect short across BOP output, then set OUTPUT to ON and Voltage to 10V. **It is necessary to wait 10 minutes before calibrating the unit to allow for thermal stabilization.** After 10 minutes, set OUTPUT to OFF and remove short from BOP output, then proceed with calibration.

All adjustments are done using the six arrow buttons of the Calibration Panel (see Figure 3-4 and Table 3-4). The double arrow buttons **◀◀** and **▶▶** either increase (**▶▶**) or decrease (**◀◀**) the output five steps at a time; the **←** and **→** buttons either increase (**→**) or decrease (**←**) the output one step at a time. The triple arrow buttons **◀◀◀** and **▶▶▶** either increase (**▶▶▶**) or decrease (**◀◀◀**) the output 80 steps at a time. The **◀◀**, **▶▶**, **←**, and **→** buttons only work within the 80-step window established by **◀◀◀** and **▶▶▶**.

For MAX and MIN Calibrations fine adjustment is done using the **◀◀**, **▶▶**, **←**, and **→** buttons. If the value can not be set within the specified tolerance using the fine adjustment, use the coarse adjustment to increase (**▶▶▶**) or decrease (**◀◀◀**) the output as needed, then use the fine adjust buttons to set the value within tolerance. Where large adjustment is necessary, **◀◀◀** and **▶▶▶** can be used first to bring the output close before using the **◀◀**, **▶▶**, **←**, and **→** buttons.

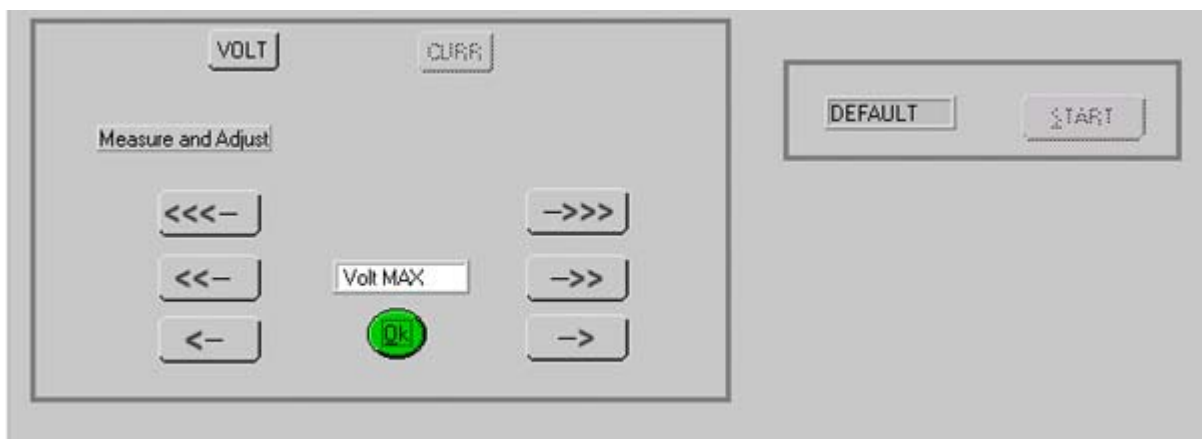

FIGURE 3-4. CALIBRATION PANEL

TABLE 3-4. CALIBRATION PANEL FUNCTIONS

BUTTON OR WINDOW	Function
START button	Initiates calibration.
Text box (Adjacent to START button)	Used to enter unit password.
VOLT button	Initiates Voltage calibration.
CURR button	Initiates Current calibration.
Message box (below VOLT buttons)	Provides instructions about the calibration process.
White text window (above OK button)	Displays the parameter currently being calibrated.
← button	Fine Adjustment - Decreases the output value by one LSB.
→ button	Fine Adjustment - Increases the output value by one LSB.
◀◀ button	Adjustment - Decreases the output value by five LSBs.
▶▶ button	Adjustment - Increases the output value by five LSBs.
◀◀◀ button	Coarse Adjustment - Decreases the output value by 80 LSBs.
▶▶▶ button	Coarse Adjustment - Increases the output value by 80 LSBs.
OK button	Enters the value displayed in the white text window.

3.3.2.2 CALIBRATION PROCEDURE

1. Click on the **Calibration Off** button on the main panel (see Figure 3-4). This will open a calibration panel (see Figure 3-4 and Table 3-4) that allows calibration in either voltage or current mode.
2. The password (DEFAULT) has been set at the factory. If it has not been changed, it will be displayed in the box adjacent to the **Start** button on the right side of the panel. If the password has been changed from DEFAULT, substitute the proper password in the box adjacent to the **Start** button and click the **Start** button. If the password has been forgotten, consult factory. If the password is correct, the **Volt** and **Curr** buttons will become active. Otherwise the message **ERROR! - Wrong Password** is displayed and you must enter the correct password and click **Start** again.
3. For Voltage Calibration, click **Volt** button. The text window reads **volt ZERO** and the message **Adjust for ZERO R81 (Eo Zero) on BOP A1 card.** is displayed.
4. Connect a DVM to the output of the unit and adjust the R81 Potentiometer on A1 board of BOP until the DVM reads the voltage specified in Table 3-1 for Low Range Zero, then click **OK** button.

NOTE: Use external DVM for all measurements.

5. The text window reads **volt ZERO** and the message **Measure and Adjust.** is displayed. Using the **←** and **→** and **◀** and **▶** buttons (see PAR. 3.3.2.1), adjust the output until the DVM reads the voltage specified in Table 3-1 for VOLT ZERO, then click **OK** button.
6. The text window reads **volt MAX** and the message **Measure and Adjust.** is displayed. Using the **←** and **→** and **◀** and **▶** buttons (see PAR. 3.3.2.1), adjust until DVM reading is as specified in Table 3-1 for High Range Accuracy. Click **OK** when done.
7. The text window reads **volt MIN** and the message **Measure and Adjust.** is displayed. Using the **←** and **→** and **◀** and **▶** buttons (see PAR. 3.3.2.1), adjust until DVM reading is as specified in Table 3-1 for High Range Accuracy, then click **OK** button. NOTE: If the **<<<←** or **→>>>** button is depressed, return to step 6 after clicking **OK**.
8. The text window reads **lvolt MAX** and the message **Measure and Adjust.** is displayed. Using the **←** and **→** and **◀** and **▶** buttons (see PAR. 3.3.2.1), adjust output until DVM reads voltage specified in Table 3-1 for Low Range Accuracy, then click **OK** button.
9. The text window reads **lvolt MIN** and the message **Measure and Adjust.** is displayed. Using the **←** and **→** and **◀** and **▶** buttons (see PAR. 3.3.2.1), adjust until DVM reads voltage specified in Table 3-1 for Low Range Accuracy, then click **OK** button. NOTE: If the **<<<←** or **→>>>** button is depressed, return to step 8 after clicking **OK**.
10. The text window reads **volt PROTECT** and the message **Measure and Adjust.** is displayed. Using the **←** and **→** and **◀** and **▶** buttons (see PAR. 3.3.2.1), adjust until DVM reading is as specified in Table 3-1. Click **OK** when done.
11. Voltage calibration is complete. If desired, the voltage calibration can be repeated by clicking **Volt** at the calibration panel (Figure 3-4). If current calibration is not necessary, proceed to step 23.

12. At the calibration panel (Figure 3-4) click **CURR** to begin current calibration of the unit. **Connect CALIBRATION RESISTOR!** window opens.
13. Connect load (see Table 3-3) across the output of the unit and connect DVM across the load as shown in Figure 3-2. Voltage measurements must be converted to Amperes using Ohm's law, $E = IR$. Click **OK** button to close **Connect CALIBRATION RESISTOR** window.
14. The test window reads **LCurr ZERO** and the message **Adjust for ZERO R83 (lo Zero) on BOP A1 card.** will be displayed.
15. Adjust the R83 Potentiometer on A1 board of BOP, until the external DVM reads voltage specified in Table 3-2, then click **OK** button.
16. The text window reads **LCurr MAX** and the message **Measure and Adjust.** is displayed. Using the **←** and **→** and **◀** and **▶** buttons (see PAR. 3.3.2.1), adjust output until DVM reads voltage specified in Table 3-2 for Low Current Accuracy, then click **OK** button.
17. The text window reads **LCurr MIN** and the message **Measure and Adjust.** is displayed. Using the **←** and **→** and **◀** and **▶** buttons (see PAR. 3.3.2.1), adjust until DVM reads voltage specified in Table 3-2 for Low Current Accuracy, then click **OK** button. NOTE: If the **<<<←** or **→>>>** button is depressed, return to step 16 after clicking **OK**.
18. The text window reads **Curr ZERO** and the message **Measure and Adjust.** is displayed. Using the **←** and **→** and **◀** and **▶** buttons (see PAR. 3.3.2.1), adjust the output until the DVM reads the voltage specified in Table 3-2 for Main Current Zero, then click **OK** button.
19. The text window reads **Curr MAX** and the message **Measure and Adjust.** is displayed. Using the **←** and **→** and **◀** and **▶** buttons (see PAR. 3.3.2.1), adjust output until DVM reads the voltage specified in Table 3-2 for High Current Accuracy, then click **OK** button.
20. The text window reads **Curr MIN** and the message **Measure and Adjust.** is displayed. Using the **←** and **→** and **◀** and **▶** buttons (see PAR. 3.3.2.1), adjust until DVM reading is as specified in Table 3-2 for High Current Accuracy. NOTE: If the **<<<←** or **→>>>** button is depressed, return to step 19 after clicking **OK**.
21. The text window reads **Curr PROTECT** and the message **Measure and Adjust.** is displayed. Using the **←** and **→** and **◀** and **▶** buttons (see PAR. 3.3.2.1), adjust until DVM reading is as specified in Table 3-2. Click **OK** when done.
22. Current calibration is complete. If desired, the current calibration can be repeated by clicking **Curr** at the calibration panel (Figure 3-4).
23. To exit Calibration, click on the **Calibration On** button on the main panel (Figure 3-3). This will open a panel that allows the calibration to be saved. Click **SAVE** to save the calibration constants (both voltage and current), or **CANCEL** to return to the old calibration.

SECTION 4 - OPERATION

4.1 GENERAL

The Kepco BOP Power Supply, with an installed BIT 4886 Interface Card, may be programmed over the IEEE 488 standard communication bus (General Purpose Interface Bus, GPIB) using SCPI (Standard Commands for Programmable Instruments). SCPI provides a common language used in an automatic test system. (Refer to Table 2-3 for input/output signal allocations.)

CAUTION: DO NOT repeatedly toggle the circuit breaker/switch as this may cause unit to fault. Set Power ON/OFF circuit breaker/switch on front panel to ON. If actuator does not lock when released, wait a few seconds before trying again. The circuit breaker is "trip-free" design; if overload exists, contacts cannot be held closed by actuator.

NOTE: Upon power up, the BOP output is set to off, VOLTage and CURRent are set to 0. VOLTage and CURRent commands will not change the BOP output until the command OUTPut ON is sent to the BIT 4886.

4.1.1 PROGRAMMING TECHNIQUES TO OPTIMIZE POWER SUPPLY PERFORMANCE

Proper programming techniques can offer significant response time improvement and reduce undesirable transients at the power supply output. The key to performance optimization is to minimize mode changes (voltage mode/current limit to current mode/voltage limit or vice versa). Mode changes should be limited to changes in load conditions (to which the power supply will respond automatically), or by programming the limit parameter when required by the user application.

The proper way to program the power supply is to initially program the operating parameter to zero and the complementary limit parameter to the desired maximum value. Subsequent commands should change only the operating parameter. (The operating parameter is the parameter that controls the output, e.g., voltage controls the output in voltage mode, current in current mode.) The complementary limit parameter should be programmed only when there is a need to change it.

4.1.1.1 EXAMPLE OF PROPER PROGRAMMING

Assume the power supply is intended to operate in a test application that requires a set of specific output voltages. The initial set of commands should program output voltage and current limit. If the same current limit applies to the rest of the test, all subsequent commands should only program output voltage.

4.1.1.2 MAKING SURE THE PREVIOUS COMMAND IS COMPLETE

Some SCPI commands require a flash memory update and can take an indeterminate amount on time to complete. These commands are:

- *SAV
- MEM:PACK
- MEM:UPD
- CAL:COPY
- CAL:SAVE
- SYST:PASS:NEW
- SYST:SEC:IMM

When sending these commands via the GPIB, these commands require a query to be added to the command string to verify the previous command is complete. When the command is complete, the unit updates the status byte and indicates MAV (Message Available, bit 4 - see Table A-3) is true. MAV indicates that there is a response to be received by the computer, so when it becomes set, the unit is ready for its next command after reading back the data from the query that was added to the command string.

When sending the above commands via the RS 232 bus, data flow control must be enabled (XON) for the unit to properly update flash memory.

The *OPC? query is ideal to check if the previous command is complete since it returns either a 1 or 0. It is important that it be sent as a part of the same string as the command that causes a flash update. As an example, sending CAL:SAVE 12/31/2005;*opc? or *opc?;:CAL:SAVE 12/31/2005 are valid command strings. Sending the commands separately will not verify that the previous command is complete. Figure 4-1 is a program written in C, incorporating these techniques.

```
#include <formatio.h>
#include <utility.h>
#include <gpib.h>
#include <ansi_c.h>

/*Overhead for the use of a NATIONAL INSTRUMENTS gpib interface */
int unit_desc;           // handle for the national instruments controller
int GPIbus=0;           // GPIB card 0
int adr=6;              // Power Supply address
char status_byte;       // status byte from the power supply

#define MAV 0x10 /* bit 4 of the status byte is the Message AVailable bit by 488.2 specification */

/* Function Send_with_wait

INPUT: string to be sent to power supply

Description: adds the *OPC? query and performs serial polls to wait for the command to be completed.

*/

int Send_with_wait(char *command);
char snd[501];           // data to be sent to the power supply
char rcv [10];          // data from power supply
int j;

sprintf(snd,"%s;*OPC?,command); // Add *OPC? to the command
// so there is a response from the
// power supply
Send(GPIbus, adr, snd, strlen(snd), 2); // Send the data to the power supply
for (j=0;j<500;j++){ // loop until ready (5 seconds max)
    Delay(.05); // Wait for command to complete
    ibrsp(unit_desc,&status_byte); // get status byte
    if ((status_byte& 0x10) ==0x10) break; // by looking for data in string
Receive (GPIbus, adr, rev, rev_buf_size,10); // so the error queue will not receive a 410 error
}

main( // test code to show operation of function.
    unit_desc=ibdev(GPIbus,adr,adr/256,T100ms,1,0x40a);Delay(.005);
    Send (GPIbus,adr,"VOLT 10;curr .01",sizeof("VOLT 10;curr .01"),NLEND;
    Send_with_wait("*SAV 10");
}
```

FIGURE 4-1. PROGRAMMING EXAMPLE TO VERIFY PREVIOUS COMMAND HAS COMPLETED

Failure to provide an adequate delay can result in:

- Commands that are not processed,
- The following command may be received in error, causing an error in the transmission,
- Unit lock-up requiring power cycling of the unit. If working via the GPIB bus, sending Interface Clear and Device Clear followed by *RST will unlock the unit.

4.2 INITIALIZATION OF THE BIT 4886 CARD

When a BIT 4886 Card is installed in a BOP it must be initialized prior to use. The initialization of the BOP BIT card can be performed via either GPIB or RS 232 ports. The process can be accomplished using the supplied computer program via the GPIB (see PAR. 4.2.1) or by sending SCPI commands using either the RS 232 or GPIB protocol (see PAR. 4.2.2).

4.2.1 INITIALIZATION USING CVI DRIVER - GPIB PORT ONLY

The initialization procedure uses the “soft” front panel which is part of the CVI driver for the BIT 4886. The CVI Driver can be downloaded from the Kepco website at: www.kepcopower.com/drivers.htm by choosing the appropriate model and CVI configuration. The CVI Driver can not be used via the RS 232 Port.

1. Unzip the files and doubleclick on setup.exe to install the driver. The bit_mdac folder will be added to the Start - Programs folder. Doubleclick bit_mdac.exe to run the program, and refer to the visamdac.pdf in the bit_mdac folder for details about using the soft front panel.
2. Connect GPIB cable from the rear of the BOP with BIT 4886 Card installed to a Microsoft Windows-based computer with National Instruments VISA software installed and verify that BOP has standard PC-12 connector installed (Figure 2-2).
3. Install the VISA driver per the text file included with the driver. At the Start-up screen (Figure 4-2) set the correct GPIB Address and click **CONNECT**. Upon successful initialization the initialization window closes and the Power Supply Type field of the Start-up window (Figure 4-2) shows BIT 4886. Click **Continue**.
4. Refer to Figure 4-3 and enter the following information:
 - **Select Model:** e.g., BOP 100-2.
 - **Serial Number:** Enter serial number found on the rear nameplate of BOP power supply.
 - **Option Number:** If unit is a special (modified) unit, enter 5-digit suffix found in the Manual Addendum
 - Press the **Initialize Card** button

NOTE: If initialization fails and an error message is displayed, repeat step 3, making sure that the proper information is entered



FIGURE 4-2. VISA DRIVER START-UP

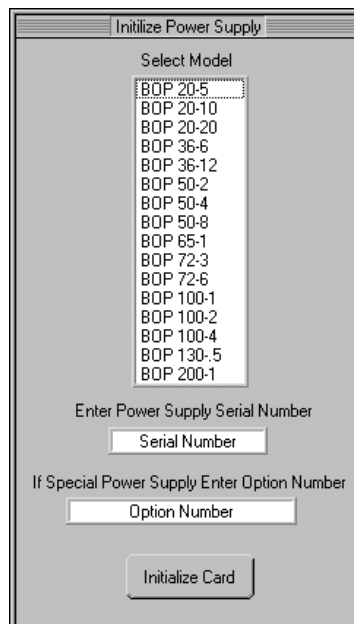

FIGURE 4-3. BIT 4886 CARD INITIALIZATION USING VISA DRIVER

1. After initialization, proceed to PAR. 3.3.2 to calibrate the upgraded unit.

4.2.2 INITIALIZATION USING SCPI COMMANDS AND GPIB PORT

1. With the BOP power off, place the five address switches to the on position (see Figure 2-1 for switch location).
2. Insure a GPIB controller is connected to the BOP via the GPIB cable. Set BOP power to OFF and set the address switches to the proper GPIB address to be used (refer to PAR 2.2.1, Figure 2-1, and Table 2-2 for addresses). Set BOP Power on; it may beep three times indicating it is ready for initialization.
3. Using the GPIB interactive mode, set up the GPIB interface. For a National Instruments card, it is done by the following steps.
 - A. Start the interactive GPIB program.
 - B. Type `ibfind DEVx` where x is the hex address of the BOP.
 - C. Type `ibwrt "*idn?"`
 - D. Type `IBREAD 100`. The GPIB will show the identifier string of the BOP as: **KEPCO, BOP 200-20**, with additional characters indicating the revision level of the firmware.
4. Send the password initialization string of: `SYST:PASS:CEN DEFAULT`.
5. Send the BOP configuration code. The configuration code format is VOLTAGE,CURRENT; for example the 100 Volt, 1 Amp BOP 100-1M is identified as 100,1. The sequence to be sent is: `DIAG:PST 100,1`.

6. Calibrate the unit per PAR. 3.3. Failure to calibrate the unit will result in the *TST? query reporting a FLASH memory error.
7. After the calibration has been completed, the master calibration levels can be established using the following command: **CAL: COPY WORK FACT**.

4.2.3 INITIALIZATION USING SCPI COMMANDS AND RS 232 PORT

1. With the BOP power off, place the five address switches to the on position (see Figure 2-1 for switch location).
2. Set BOP power to OFF and set the address switches to the proper GPIB address to be used (refer to PAR 2.2.1, Figure 2-1, and Table 2-2 for addresses). Set BOP Power on; it may beep three times indicating it is ready for initialization.
3. Set up the RS 232 interface as indicated by the following steps.
 - A. Start the Hyperterminal
 - B. Set Hyperterminal to direct connect at 9600 baud.
 - C. Type ***idn?**
 - D. Unit responds with the identifier string of the BOP, e.g.,: **KEPCO, BOP 200-20**, with additional characters indicating the revision level of the firmware.
4. Send the password initialization string of: **SYST: PASS: CEN DEFAULT**.
5. Send the BOP configuration code. The configuration code format is VOLTAGE,CURRENT; for example the 100 Volt, 1 Amp BOP 100-1M is identified as 100,1. The sequence to be sent is: **DIAG: PST 100,1**.
6. Calibrate the unit per PAR. 3.3. Failure to calibrate the unit will result in the *TST? query reporting a FLASH memory error.
7. After the calibration has been completed, the master calibration levels can be established using the following command: **CAL: COPY WORK FACT**.

4.2.4 PASSWORD SETUP.

To change a password send:

SYST: PASS: CEN DEFAULT

SYST: PASS: NEW DEFAULT new_password

4.2.4.1 FORGOTTEN PASSWORDS

If the password is lost, it is possible to enable the password interface by sending

SYST: PASS: CEN POWERSUPPLIER

Once enabled, the password can be set to DEFAULT by sending

SYST: SEC: OVERRIDE

4.3 BUILT IN TEST

The BIT 4886 card is designed to perform periodic testing of itself, power up testing and commanded testing. The testing is reported to the operator both by errors placed in the SCPI error queue and by issuing audible beeps.

The driver and demonstration soft panel which can be downloaded from the Kepco website at: www.kepcopower.com/drivers.htm provide an easy way to verify BIT 4886 performance. A description of the driver is included as an Adobe Acrobat™ PDF file.

4.3.1 POWER-UP TEST

The power up testing of the BIT 4886 is similar to the *TST command (PAR. A.17). Portions of the card are verified on power-up and errors are indicated by the beep codes listed in Table 4-1. The failed test is repeated indefinitely. The power-up test can be bypassed by placing all DIP switch positions of address switch S1 to up (ON, 1). Once bypassed, the unit beeps on and off at equal intervals to indicate the address switches are set to 1 and the unit is waiting for the address switches to be set to a valid GPIB address.

4.3.2 CONFIDENCE TEST

The SCPI command *TST? Is used to perform a confidence test of the interface. It verifies the microprocessor memory, the timer, optical buffer and reference of the BIT 4886 card. It does not affect the output of the BOP. This command returns a 0 for pass and number from 1 through 1023 to indicate the cause of the error. The test executes each of the subtests even when any one fails. If any test fails a bit is set in the error code which is returned to the user. The error codes returned are listed in Table 4-1

TABLE 4-1. BUILT-IN TEST ERROR CODES

TEST ACTIVE		ERROR CODES			MEANING
*tst?	DIAG:TST?	BIT	VALUE	BEEPS	
Yes	Yes		0		Pass (No error)
Yes	Yes	0	1	1	ROM error
Yes	Yes	1	2	1	RAM error
Yes	Yes	2	4	2	FLASH error -- Perform calibration to correct
Yes	Yes	3	8	3	Optical Buffer Error'
Yes	Yes	4	16	6	Digital Pot error
No	Yes	5	32	5	Loop Back Test error
No	Yes	6	64		Max Voltage Output error
No	Yes	7	128		Min Voltage Output error
No	Yes	8	256		1/4 Scale Voltage error
No	Yes	9	512		1/4 Scale Voltage Readback error

4.3.3 BOP TEST

The DIAG:TST? Command performs a test of the BOP instrument. The test includes the BIT 4886 internal tests of the DAC (Digital to Analog Converter), Limit and Op Amp circuits. If successful it programs the BOP in voltage mode to the positive and negative limits of the device. It also verifies the Limit operation of the unit in current mode by setting the unit for the rated maxi-

imum current delivery and verifies that the voltage limit set at one volt operates correctly. It also tests the readback voltages in both high and low scales.

CAUTION: TO AVOID DAMAGE TO THE LOAD, DISCONNECT THE LOAD BEFORE ISSUING THIS COMMAND. (DURING THE SELF-TEST, THE BOP IS PROGRAMMED TO FULL SCALE POSITIVE AND FULL SCALE NEGATIVE OUTPUT.)

This command returns a 0 for pass, or a number from 1 through 1023 to indicate the cause of the error. The test executes each of the subtests even when any one fails. If any test fails, a bit is set in the error code which is returned to the user. The error codes returned are listed in Table 4-1.

4.4 IEEE 488 (GPIB) BUS PROTOCOL

Table 4-2 defines the interface capabilities of the Interface Card (Talker/Listener) relative to the IEEE 488 (GPIB) bus (reference document *ANSI/IEEE Std 488: IEEE Standard Digital Interface for Programmable Instrumentation*) communicating with a Host Computer–Controller (Talker/Listener).

TABLE 4-2. IEEE 488 (GPIB) BUS INTERFACE FUNCTIONS

FUNCTION	SUBSET SYMBOL	COMMENTS
Source Handshake	SH1	Complete Capability (Interface can receive multiline messages).
Acceptor Handshake	AH1	Complete Capability (Interface can receive multiline messages).
Talker	T6	Basic talker, serial poll, unaddress if MLA (My Listen Address) (one-byte address).
Listener	L4	Basic listener, unaddress if MTA (My Talk Address) (one-byte address).
Service Request	SR1	Complete Capability. The interface sets the SRQ line true if there is an enabled service request condition.
Remote/Local	RL2	No Local lock-out.
Parallel Poll	PP0	No Capability.
Device Clear	DC1	Complete Capability. Controller sends DCL (Device Clear) and SDC (Selected Device Clear) to selected power supply.
Device Trigger	DT1	Complete Capability.
Controller	C0	No Capability.

Tables 4-3 and 4-4 define the messages sent to the Interface Card, or received by the Interface Card, via the IEEE 488 bus in IEEE 488 command mode and IEEE 488 data mode, respectively. These messages are enabled during the “handshake” cycle, with the Interface Card operating as either a Talker or a Listener.

4.5 RS232-C OPERATION

The BIT 4886 card allows the BOP to be operated via an RS232-C terminal, or from a PC using a terminal emulation program. The default settings are as follows:

- Baud rate: 9600
- Parity: None
- Data Bits 8
- Stop Bits 1
- Echo ON
- XON OFF

To change echo or XON/XOFF, refer to PAR. 4.5.2.

TABLE 4-3. IEEE 488 (GPIB) BUS COMMAND MODE MESSAGES

MNEMONIC	MESSAGE DESCRIPTION	COMMENTS
ATN	Attention	Received
DAC	Data accepted	Received or Sent
DAV	Data Valid	Received or Sent
DCL	Device Clear	Received
GET	Group Executive Trigger	Received
IFC	Interface Clear	Received
MLA	My Listen Address	Received
MTA	My Talk Address	Received
OTA	Other Talk Address	Received
RFD	Ready for Data	Received or Sent
SDC	Selected Device Clear	Received
SPD	Serial Poll Disable	Received
SPE	Serial Poll Enable	Received
SRQ	Service Request	Sent
UNL	Unlisten	Received
UNT	Untalk	Received

TABLE 4-4. IEEE 488 (GPIB) BUS DATA MODE MESSAGES

MNEMONIC	MESSAGE DESCRIPTION	COMMENTS
DAB	Data Byte	Received or Sent
END	End	Received or Sent
EOS	End of String	Received or Sent
RQS	Request Service	Sent
STB	Status Byte	Sent

4.5.1 SERIAL INTERFACE

The serial interface behaves like the GPIB interface in that the command is parsed after receiving a control character of either a Line Feed or Carriage Return. The serial interface supports six special control characters. The six special control characters are:

- Escape (1B_H) Causes the input buffer to be cleared. This character is used to ensure that the buffer is empty when the host powers on since it is possible that the Interface Card was previously powered on and received some characters prior to the initialization of the host computer.
- Backspace (08_H) Causes the last character in the input buffer to be removed from the input buffer queue.
- Carriage Return (0D_H) Causes the input buffer to be parsed by the BOP.
- Line Feed (0A_H) Causes the input buffer to be parsed by the BOP.

4.5.2 RS 232 IMPLEMENTATION

The following paragraphs are provided to help the user understand how the RS 232 serial interface is implemented in the BIT 4886. Since the RS 232 protocol does not use a parity bit, the echo mode is the default method used to ensure reliable communication between the command originator (computer) and the BIT 4886, thus avoiding a more complex “handshake” protocol.

When the BIT 4886 is in the RS 232 echo mode it returns all data sent to the host controller. The BIT 4886 provides one additional option that allows handshake communication: the XON XOFF method. In standard echo mode the controller must verify that each character is echoed back by the BIT 4886. As shown in Figure 4-4, there are times when the BIT 4886 does not echo back the character from the controller, requiring that the controller resend the character. By using the handshake option (XON XOFF) the host controller can ensure that serial data interrupts occurring after parsing of the incoming message do not result in lost data.

Figure 4-4 illustrates the default echo mode and the XON XOFF method described in the following paragraphs.

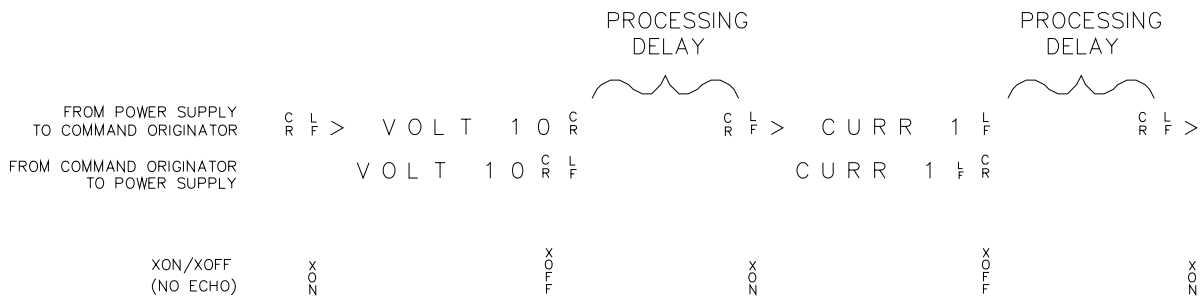

3042536

FIGURE 4-4. RS 232 IMPLEMENTATION

Only seven control characters (characters between 00_H and 1F_H) are acknowledged by the BIT 4886:

- Carriage Return (CR, 0D_H)
- Line Feed (LF, 0A_H)
- Back Space (BS, 08_H)
- Escape (ESC, 01B_H)
- XON (011_H)
- XOFF (013_H)
- CAN (018_H)

BS deletes the last character entered, with the exception of CR or LF characters. Either the CR or LF character acts as the line terminator, initiating parsing of the ASCII data sent to the BIT 4886 by the command originator. When the line is parsed and the commands are sent to the analog processor, the BIT 4886 sends the line terminator sequence CR LF to the command originator.

The ESC character is used for synchronization, causing the BIT 4886 to reset its input buffer and return a CR LF sequence.

The XON character enables the transmitter if XON/XOFF flow control is enabled (see PAR. 4.5.2.2).

The XOFF character stops data transmission if XON/XOFF flow control is enabled (see PAR. 4.5.2.2).

The CAN character resets the receive and transmit pointers and queues.

CAUTION: When the serial port has received an XOFF, the error message *-400, QUE error* will be placed in the queue to indicate the loss of transmitted information due to a received XOFF character. When XON is received, the unit will transmit all data in it's buffer followed by the exclamation character (!). This (!) character is not part of any message from the BIT 4886 and indicates the transmission buffer has been cleared and the BIT 4886 is idle.

All non-control characters are sent via the serial port of the command originator. The control character BS is echoed as BS Space BS. Only the first control character is returned in response to either a CR LF or LF CR character sequence (see Figure 4-4).

4.5.2.1 ECHO MODE

Echo mode is one method of ensuring data is transferred without errors. This mode should only be enabled when errors in operation are detected. Refer to PAR. B.76 to change the setting.

Each byte (character) is echoed back to the sender where it is verified as the same character that was just sent. If the wrong character is echoed back, sending the ESC character clears the line to allow retransmission of the character. It is important that CR and LF characters are NOT sent until the verification process is complete.

When working in echo mode, it is possible to receive the NAK (15 hex) from the BIT 4886. This indicates an unknown quantity of echoed characters have been lost due to a queue overflow problem. The error queue will also contain the *-400, QUE error* message. To prevent this, please insure the received data string does not exceed 127 characters between line terminators and no more than four queries are sent between line terminators in SCPI mode of operation

All non-control characters are sent via the serial port of the command originator.

4.5.2.2 XON XOFF METHOD

The XON XOFF method allows the BIT 4886 to control when the command originator is allowed to send data. The command originator can only send data after the XON (transmission on) character (011_H) has been received; the command originator stops sending data after receiving the XOFF (transmission off) character (013_H), and waits until the XON character is received before sending additional data. Refer to PAR. B.78 to change the setting.

Control characters, either CR or LF, are returned as XOFF CR if echo mode is on, and as XOFF if echo mode is off. XOFF stops data from the command originator and the BIT 4886 returns the normal sequence of CR LF (if echo mode is enabled).

4.5.2.3 ISOLATING RS 232 COMMUNICATION PROBLEMS

A Loop Back test can be executed to aid in isolating RS 232 communication problems. The test is executed via a SCPI command sent over the GPIB interface.

1. Send the command DIAG:LBT? to the unit via the GPIB interface with the Loop Back Test connector (Kepco P/N 195-0111) NOT installed. The response sent over the GPIB will be **FAILED**.
2. Install the Loop Back Test connector (Kepco P/N 195-0111) into the RS 232 port; if this connector is not available, skip this step and proceed to step 3. Send DIAG:LBT? again and read back the answer. if the response is PASSED, the power supply is operating properly. If the response is FAILED, the unit requires repair.
3. To test the integrity of the cable assembly connecting the BIT 4886 RS 232 port to the computer, remove the Loop Back test connector from the BIT 4886 RS 232 port and connect the cable in its place. With the DB9 adapter installed on the opposite end of the cable, connect a short jumper wire between pins 2 and 3 of the adapter connector and repeat the test of step 2 above. If the response is FAILED, the cord is either an improper type (not null modem) or

defective. If the response is PASSED, the cable is correct; remove the jumper and reconnect the cable to the computer.

4. If the loop back connector was not available and steps 1 And 3 were completed successfully, contact Kepco to obtain loop back connector P/N 195-0111 and rerun the test. If each of the above steps is completed successfully, the problem lies in the computer hardware and/or software. If the serial communication is monitored at the computer end, every DIAG:LBT? command will cause the IDN response to be sent to the computer.

4.5.3 USING SCPI COMMANDS FOR RS 232 COMMUNICATION.

The unit must be in remote mode before RS 232 commands affecting the output can be executed (e.g., VOLT 10;OUTP ON). This can be accomplished by sending SYST:REM ON prior to sending any commands that affect the power supply output. (See PAR. B.87 and Figure B-7)

4.6 SCPI PROGRAMMING

SCPI (Standard Commands for Programmable Instruments) is a programming language conforming to the protocols and standards established by IEEE 488.2 (reference document *ANSI/IEEE Std 488.2, IEEE Standard Codes, Formats, Protocols, and Common Commands*). SCPI commands are sent to the Interface Card as output strings within the selected programming language (PASCAL, BASIC, etc.) in accordance with the manufacturer's requirements for the particular GPIB interface card used.

Different programming languages (e.g., BASIC, C, PASCAL, etc.) have different ways of representing data that is to be put on the IEEE 488 bus. It is up to the programmer to determine how to output the character sequence required for the programming language used. Address information (GPIB address) must be included before the command sequence. (See PAR. 2.2.1 to establish the Interface Card GPIB address.)

4.6.1 SCPI MESSAGES

There are two kinds of SCPI messages: program messages from controller to power supply, and response messages from the power supply to the controller. Program messages consist of one or more properly formatted commands/queries and instruct the power supply to perform an action; the controller may send a program message at any time. Response messages consist of formatted data; the data can contain information regarding operating parameters, power supply state, status, or error conditions.

4.6.2 COMMON COMMANDS/QUERIES

Common commands and queries are defined by the IEEE 488.2 standard to perform overall power supply functions (such as identification, status, or synchronization) unrelated to specific power supply operation (such as setting voltage/current). Common commands and queries are preceded by an asterisk (*) and are defined and explained in Appendix A. Refer also to syntax considerations (PARs. 4.6.2 through 4.6.5).

4.6.3 SCPI SUBSYSTEM COMMAND/QUERY STRUCTURE

Subsystem commands/queries are related to specific power supply functions (such as setting output voltage, current limit, etc.) Figure 4-5 is a tree diagram illustrating the structure of SCPI subsystem commands used in the Interface Card with the "root" at the left side, and specific commands forming the branches. The following paragraphs introduce the subsystems; subsystem commands that are defined and explained in Appendix B.

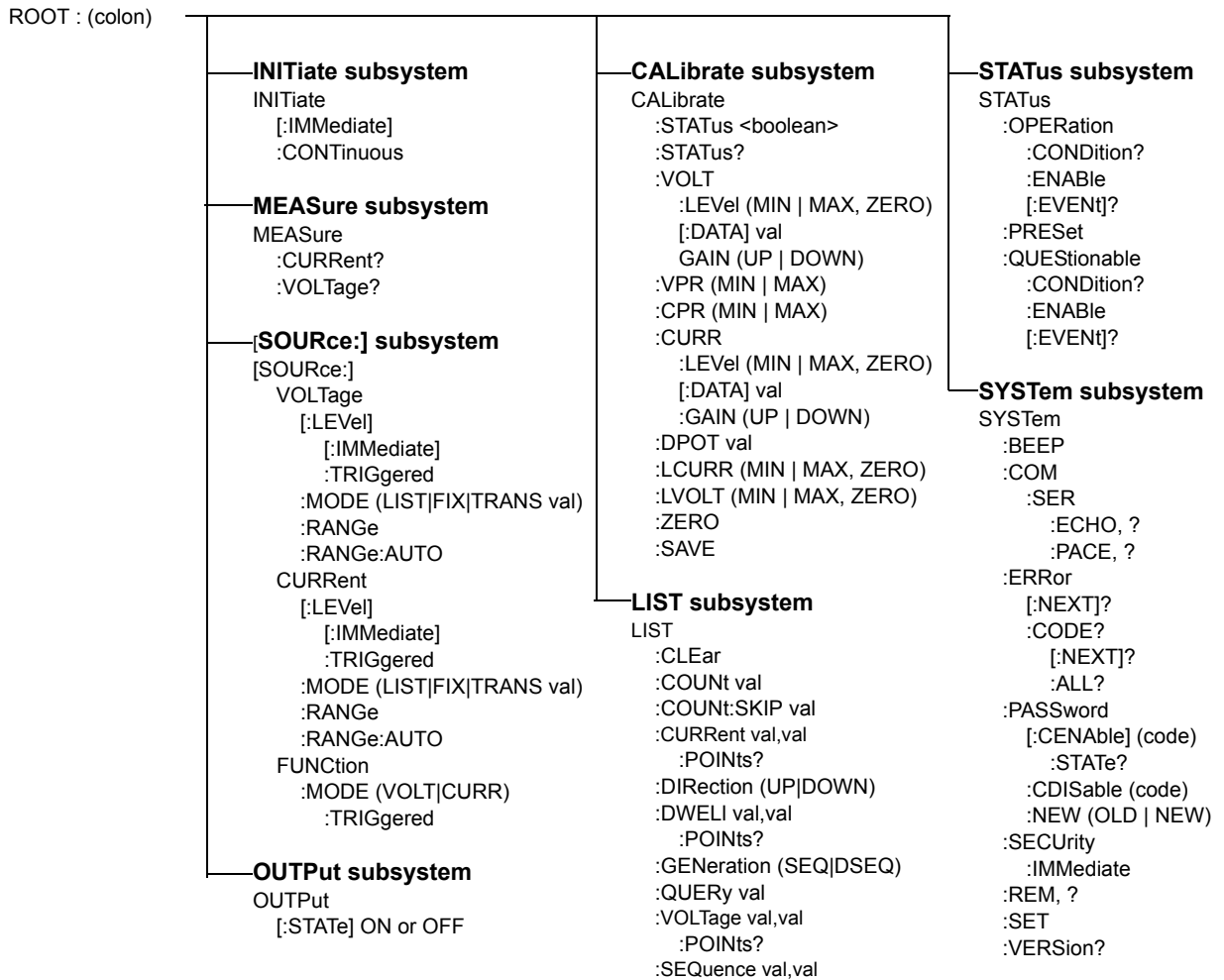

FIGURE 4-5. TREE DIAGRAM OF SCPI COMMANDS USED WITH BIT 4886 INTERFACE CARD

4.6.3.1 INITIATE SUBSYSTEM

This subsystem enables the trigger system. When a trigger is enabled, the triggering action will occur upon receipt of a GPIB <GET>, *TRG or TRIGger command. If a trigger circuit is not enabled, all trigger commands are ignored.

4.6.3.2 MEASURE SUBSYSTEM

This query subsystem returns the voltage and current measured at the power supply's output terminals.

4.6.3.3 [SOURCE:]VOLTAGE AND [SOURCE:]CURRENT SUBSYSTEMS

These subsystems program the output voltage and current of the power supply.

4.6.3.4 OUTPUT SUBSYSTEM

This subsystem enables/disables the power supply output. Voltage and current are determined by the combination of SOURCE subsystem VOLTage and CURRent commands and the load.

4.6.3.5 LIST SUBSYSTEM

The LIST subsystem is used to generate transients, waveforms and execute a series of steps repeatedly. Up to 1002 power supply settings can be stored temporarily. Each setting consists of either a voltage or current value (depending on whether the power supply has been set to Voltage or Current mode), and a corresponding dwell time (the duration those settings are in effect). These settings may be executed in sequence as they are entered, or executed in a user-determined sequence that also allows individual settings to be repeated more than once. In addition, the entire sequence may be repeated for a specific number of times, or run indefinitely until commanded to stop. The sequence can also be run in reverse order to produce inverted waveforms. The allowable dwell time for each step is between 0.0005 and 10 seconds. The following paragraphs provide guidance for using the list commands.

4.6.3.5.1 REQUIRED LIST COMMANDS

There are only five LIST commands, plus either the VOLT:MODE or CURR:MODE command, that are needed to create and execute a list. Use of these required commands is illustrated in Figure B-2 which shows the creation of sawtooth and triangular waveforms. LIST commands are not accepted while a list is running. Send VOLT:MODE FIX (PAR. B.59) or CURR:MODE FIX (PAR. B.50) to stop the list. A list remains in memory until the power is cycled or the LIST:CLEAR command is processed. Therefore, if the original list is unchanged, additional commands can be added to the end of the list without resending all the commands. However, to change parameters of one or more commands within the list, send LIST:CLEAR and then resend the entire list including the changed parameters. To execute the list again, either VOLT:MODE LIST or CURR:MODE LIST must be sent again.

LIST:VOLT (PAR. B.45) or LIST:CURR (PAR. B.31). These commands establish the points (steps) of a list which program output voltage or current. A list can only be either a voltage list or a current list, so the points in a list must be made with either LIST:VOLT XXXX or LIST:CURR XXXX. Mixing of these commands within a list is not allowed.

LIST:CLEAR (PAR. B.26). Always precede a new list with this command. A list remains in memory until the power is cycled or the LIST:CLEAR command is processed.

LIST:DWELL (PAR. B.36). Defines the dwell time for each point in a list. In many instances it is easier to use one dwell time and repeat a specific point multiple times to generate longer duration pulses. Remember, if more than one LIST:DWELL is sent, there must be a LIST:DWELL for each voltage or current point in the list.

LIST:COUNT (PAR. B.27) Defines how many times a list is executed. 0 equals indefinite; when a count of 0 is used, either *RST, VOLT:MODE FIX or CURR:MODE FIX must be used to stop the list. *RST will cause the output to be set off and the unit is set to Voltage mode. VOLT:MODE FIX or CURR:MODE FIX stops the list immediately; the point being executed when the list is stopped will be present at the BOP output.

4.6.3.5.2 OTHER REQUIRED COMMANDS

VOLT:MODE LIST (PAR. B.59) or CURR:MODE LIST (PAR. B.50). These commands start the list and VOLT:MODE FIX (PAR. B.59) or CURR:MODE FIX (PAR. B.50) stop the list. LIST com-

mands are not accepted while a list is running. If LIST:COUNT is between 1 and 255, when the count decrements to 0, the list stops and the unit automatically moves to VOLT:MODE FIXED or CURR:MODE FIXED state. To execute the list again, either VOLT:MODE LIST or CURR:MODE LIST must be sent again.

4.6.3.5.3 OTHER USEFUL COMMANDS

LIST:COUNT:Skip (PAR. B.29). This command provides the ability to execute the initial points only once whenever a list is run. It is used to set initial preconditions prior to running a repetitive sequence.

LIST:DIR (PAR. B.34) This command changes the order of the list.

LIST:VOLT:POINTS? (PAR. B.47) or LIST:CURR:POINTS? (PAR. B.33) These queries return the number of points in a list and provide a simple way to insure that all points entered were properly processed and as intended.

4.6.3.5.4 OPTIONAL COMMANDS

Most commands have associated Queries (?) These are useful for troubleshooting/debugging lists but are not needed in most cases.

The LIST:SEQ command is provided for backward compatibility. It is not recommended to be used in any new designs as it may be eliminated at some point in the future.

4.6.3.6 STATUS SUBSYSTEM

This subsystem programs the power supply status register. The power supply has two groups of status registers: Operation and Questionable. Each group consists of three registers: Condition, Enable, and Event.

4.6.3.7 SYSTEM SUBSYSTEM

This subsystem is used to establish system settings Program Message Structure.

4.6.4 PROGRAM MESSAGE STRUCTURE

SCPI program messages (commands from controller to power supply) consist of one or more *message units* ending in a *message terminator* (required by Kepco power modules). The message terminator is not part of the syntax; it is defined by the way your programming language indicates the end of a line (such as a “newline” or “end-of-line” character). The message unit is a keyword consisting of a single command or query word followed by a message terminator (e.g., CURR?<NL> or TRIG<end-of-line>). The message unit may include a data parameter after the keyword separated by a space; the parameter is usually numeric (e.g., CURR 5<NL>), but may also be a string (e.g., OUTP ON<NL>). Figure 4-6 illustrates the message structure, showing how message units are combined. The following subparagraphs explain each component of the message structure.

NOTE: An alternative to using the message structure for multiple messages defined in the following paragraphs is to send each command as a separate line. In this case each command must use the full syntax shown in Appendix B.

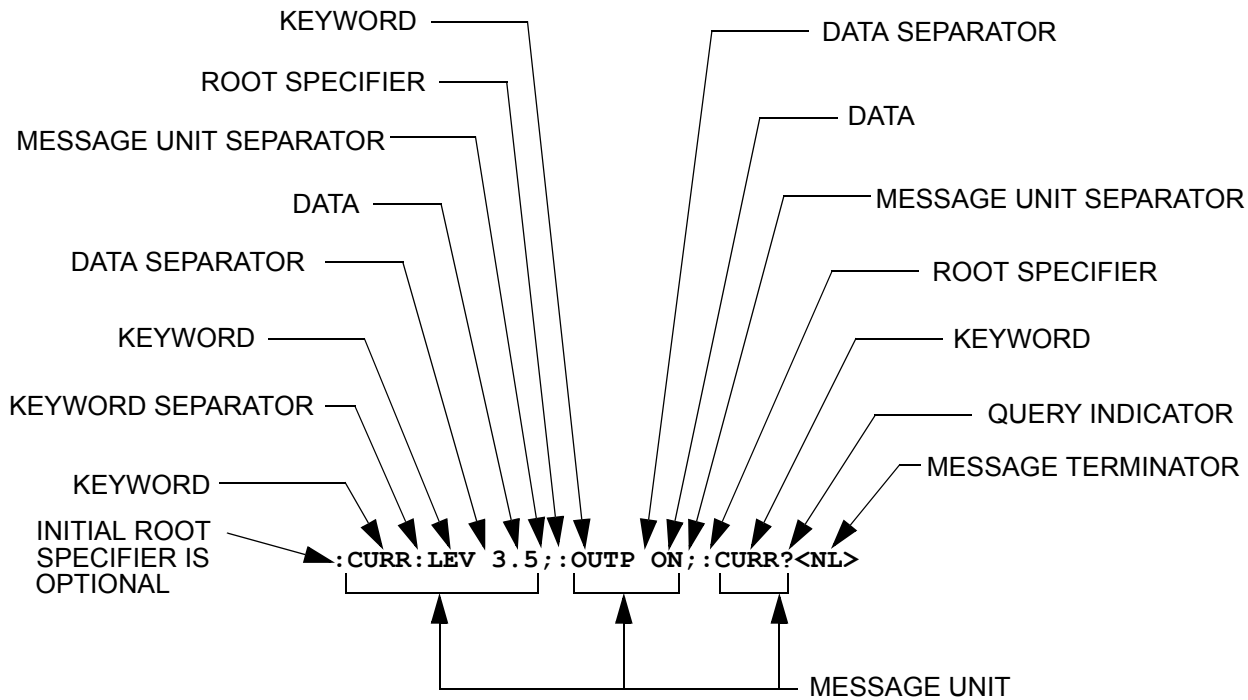

FIGURE 4-6. MESSAGE STRUCTURE

4.6.4.1 KEYWORD

Keywords are instructions recognized by a decoder within the Interface Card, referred to as a “parser.” Each keyword describes a command function; all keywords used by the Interface Card are listed in Figure 4-5.

Each keyword has a long form and a short form. For the long form the word is spelled out completely (e.g. STATUS, OUTPUT, VOLTAGE, and TRIGGER are long form keywords). For the short form only the first three or four letters of the long form are used (e.g., STAT, VOLT, OUTP, and TRIG).

To identify the short form and long form in this manual, keywords are written in upper case letters to represent the short form, followed by lower case letters indicating the long form (e.g., IMMEDIATE, EVENT, and OUTPUT). The parser, however, is not sensitive to case (e.g., outp, OutP, OUTPUT, ouTPut, or OUTp are all valid).

You must use the rules above when using keywords. Using an arbitrary short form such as ENABL for ENAB (ENABLE) or IMME for IMM (IMMEDIATE) will result in an error. Regardless of which form chosen, you must include all the letters required by that form.

4.6.4.2 KEYWORD SEPARATOR

If a command has two or more keywords, adjacent keywords must be separated by a colon (:) which acts as the keyword separator (e.g., CURR:LEV:TRIG). The colon can also act as a root specifier (paragraph 4.6.4.7).

4.6.4.3 QUERY INDICATOR

The question mark (?) following a keyword is a query indicator. This changes the command into a query. If there is more than one keyword in the command, the query indicator follows the last keyword. (e.g., `VOLT?` and `MEAS:CURR?`).

4.6.4.4 DATA

Some commands require data to accompany the keyword either in the form of a numeric value or character string. Data always follows the last keyword of a command or query (e.g., `VOLT:LEV:TRIG 14` or `SOUR:VOLT? MAX`).

4.6.4.5 DATA SEPARATOR

Data must be separated from the last keyword by a space (e.g., `VOLT:LEV:TRIG 14` or `SOUR:VOLT? MAX`).

4.6.4.6 MESSAGE UNIT SEPARATOR

When two or more message units are combined in a program message, they must be separated by a semicolon (;) (e.g., `VOLT 15;MEAS:VOLT?` and `CURR 12;CURR:TRIG 12.5`).

4.6.4.7 ROOT SPECIFIER

The root specifier is a colon (:) that precedes the first keyword of a program message. This places the parser at the root (top left, Figure 4-5) of the command tree. Note the difference between using the colon as a keyword separator and a root specifier in the following examples:

`VOLT:LEV:IMM 16` The root specifier is not necessary for the first keyword and has been omitted. Both colons are keyword separators.

`:CURR:LEV:IMM 4` Even though it is not required, it is still correct to include the root specifier (first colon). The other two are keyword separators.

`VOLT:LEV 6;:CURR:LEV 15` The root specifier for VOLT is not necessary because it is the first keyword in the string and has not been included. The second colon is the root specifier for CURR and is required; if it is missing an error will result. The first and third colons are keyword separators.

`:INIT ON;:TRIG;:MEAS:CURR?:VOLT?` The first three colons are root specifiers. The fourth colon is a keyword separator.

4.6.4.8 MESSAGE TERMINATOR

The message terminator defines the end of a message. Three message terminators are permitted:

- new line (<NL>), ASCII 10 (decimal) or 0A (hex)
- carriage return (<CR>), ASCII 13 (decimal) or 0D (hex)
- both of the above (<CR> <NL>). If both are sent, the second is null and has no effect.

Your GPIB interface card software will automatically send a message terminator. For example, the HP BASIC OUTPUT statement inserts <NL> after the last data byte. When binary data is

exchanged, <END> must be used. The combination <NL><END> terminator can be used for all data except binary data.

NOTE: Kepco power modules *require* a message terminator at the end of each program message. The examples shown in this manual assume a message terminator will be added at the end of each message. Where a message terminator is shown it is represented as <NL> regardless of the actual terminator character.

4.6.5 UNDERSTANDING THE COMMAND STRUCTURE

Understanding the command structure requires an understanding of the subsystem command tree illustrated in Figure 4-5. The "root" is located at the top left corner of the diagram. The parser goes to the root if:

- a message terminator is recognized by the parser
- a root specifier is recognized by the parser

Optional keywords are enclosed in brackets [] for identification; optional keywords can be omitted and the power supply will respond as if they were included in the message. The root level keyword [SOURCE] is an optional keyword. Starting at the root, there are various branches or paths corresponding to the subsystems. The root keywords for the Interface Card are :INITiate, :MEASure, :OUTPut, [:SOURCE], :STATus, and :SYSTEM. Because the [SOURCE] keyword is optional, the parser moves the path to the next level, so that VOLTage, CURRent, and FUNction commands are at the root level.

Each time the parser encounters a keyword separator, the parser moves to the next indented level of the tree diagram. As an example, the STATus branch is a root level branch that has three sub-branches: OPERation, PRESet, and QUEStionable. The following illustrates how SCPI code is interpreted by the parser:

STAT:PRES<NL>

The parser returns to the root due to the message terminator.

STAT:OPER?;PRES<NL>

The parser moves one level in from STAT. The next command is expected at the level defined by the colon in front of OPER?. Thus you can combine the following message units STAT:OPER? and STAT:PRES;

STAT:OPER:COND?;ENAB 16<NL>

After the OPER:COND? message unit, the parser moves in one level from OPER, allowing the abbreviated notation for STAT:OPER:ENAB.

4.6.6 PROGRAM MESSAGE SYNTAX SUMMARY

- Common commands begin with an asterisk (*).
- Queries end with a question mark (?).
- Program messages consist of a root keyword and, in some cases, one or more message units separated by a colon (:) followed by a message terminator. Several message units of a program message may be separated by a semicolon (;) without repeating the root keyword.

- If a program message has more than one message unit, then a colon (:) must precede the next keyword in order to set the parser back to the root (otherwise the next keyword will be taken as a subunit of the previous message unit).

e.g., the command `meas:volt?;curr?` will read output voltage and output current since both `volt?` and `curr?` are interpreted as subunits of the `meas` command.

- Several commands may be sent as one message; a line feed terminates the message. Commands sent together are separated by a semicolon (;). The first command in a message starts at the root, therefore a colon (:) at the beginning is not mandatory.

e.g., the command `meas:volt?;curr?` will read output voltage and output current, however the command `meas:volt?;:curr?` will read actual output voltage and *programmed current* since the colon preceding `curr?` indicates that `curr?` is not part of the `meas` command and starts at the root.

- UPPER case letters in mnemonics are mandatory (short form). Lower case letters may either be omitted, or must be specified completely (long form)
e.g., `INSTrument` (long form) has the same effect as `INST` (short form).
- Commands/queries may be given in upper/lower case (long form)
e.g., `SoURce` is allowed.
- Text shown between brackets [] is optional.
e.g., `[SOUR:]VOLT[:LEV]:TRIG` has the same effect as `VOLT:TRIG`

4.6.7 SCPI PROGRAM EXAMPLE

Figure 4-7 is an example of a program written in C using SCPI commands to program a BOP Power Supply. The program illustrated is for a configuration using a National Instruments GPIB interface card. (It will be necessary to consult the manufacturer's data to achieve comparable functions with an interface card from a different manufacturer.) This program sets output voltage (Voltage mode) or voltage limit (Current mode) to 5V, and current limit (Voltage mode) or output current (Current mode) to 1A, then reads the measured (actual) voltage and current, then prints the measurements.

4.7 ENHANCED OPERATION

The following paragraphs describe options that will permanently modify the behavior of the BIT 4886 and associated BOP power supply. Although these options use SCPI commands, they are not intended to be used during normal programming of the BOP output.

The commands described in the following paragraphs affect only RAM variables. The power up state of the variables is retrieved from the FLASH EEPROM. The command `MEMORY:UPDATE` can be used to copy this RAM information to the FLASH EEPROM. The `WINDOW` variable is stored using the command `MEM:UPDATE SHUTDOWN` and the other variables, including the `DIAG:SAV` command, use the command `MEMORY:UPDATE INTERFACE`

```

/*****
/*   Sample Program (written in C) for KEPCO power supply using   */
/*   National Instruments GPIB interface card                     */
/*****

#include <stdio.h>
#include "decl.h"
char rd_str[80];           // Input buffer
char dat_str[80];         // Output buffer
int bd,adr;
main() {
    adr = ibfind("DEV6");           // Open DEV6 (defined by IBCONF)
    bd = ibfind ("GPIB0");         // Open GPIB card
    ibsic (bd);                   // Send Interface Clear
    strcpy(dat_str,"OUTPUT ON");   // SCPI default is Output off
    ibwrt(adr,dat_str,strlen(dat_str)); // Power supply is
                                    // in voltage mode
                                    // outputing 0 volts
    strcpy(dat_str,"VOLT 5;CURR 1"); // Define a set command
    ibwrt(adr,dat_str,strlen(dat_str)); // Send string to power supply
    strcpy(dat_str,"MEAS:VOLT?;CURR?"); // Define a measure command
    ibwrt(adr,dat_str,strlen(dat_str)); // Send string to power supply
    strset(rd_str,'\0');          // Clear input buffer
    ibrd(adr,rd_str,64);          // Read result of measure
    printf("received : %s\n",rd_str); // Print voltage and current
}

/*****

```

FIGURE 4-7. TYPICAL EXAMPLE OF INTERFACE CARD PROGRAM USING SCPI COMMANDS

4.7.1 ERROR DETECTION

The BIT 4886 card has the ability to alter the way the unit responds to detection of load and settings errors. The default behavior is for the BIT 4886 to measure the main channel and verify that it is within the specified channel tolerances of the BOP, setting the appropriate bits in the Status Questionable register. This default behavior is established by the SYST:SEC:IMM command and the factory default window of 32 LSBs.

The default behavior can be modified using the DIAG:ERR, DIAG:ONL, DIAG:OFFL AND DIAG:WIN commands listed in Table 4-5 so that device errors are generated for conditions such as window exceeded, output current limit at setting and output current exceeding a hard limit. These errors can also be used to force the unit to go to an output off state upon detecting the errors. The behavior is altered, the new setting is stored in RAM and it remains in effect until a power off/power on cycle. The settings can be saved for power up by sending the MEMORY:UPDATE SHUTDOWN command. Error responses are listed in Table 4-5.

4.7.2 LIMIT CHANNEL CONTROL

The unit supports three limit settings for the output off state. The standard configuration is for the limits to be set to the minimum levels which causes the output not to vary beyond the BOX limits defined in the BOP manual. The limits can also be set to maximum or 110% of rated voltage or current. This is useful for battery operation. These limit settings are established by the DIAG:OUTPut command. With other types of devices, it is possible to set the output off limit channels to be at any level by using the DIAG:OFFLimit commands to establish the limit for the

output off state. DIAG:OUTP n_H (see Table 4-5) controls the limit DAC values when the output is set to OFF; $n = 0$ is the default. This sets both voltage and current limit channels to 0 when the output is off. $n = 1$ sets voltage limit to maximum when the output is off. $n = 2$ sets the current limit to the maximum when the output is off. Bits 2 and 3 of the hex character allow the DIAG:OFFLimit commands to establish a specific voltage limit and current limit, respectively, when the output is off. Bits 0 and 2 or bits 1 and 3 should not be set at the same time since the maximum setting will override the value specified by DIAG:OFFLimit. The SYST:SEC:IMM command sets DIAG:OUTP $n = 0$. The variables are stored in non-volatile EEPROM by the command MEMORY:UPDATE INTERFACE.

4.7.3 USING AND SAVING SYSTEM VARIABLES

The DIAG:SAV command prepares the variables established by the SYST:SET command see (PAR. B.90) to be stored and used for subsequent power up cycles. However, executing SYST:SEC:IMM (PAR. B.89) restores the following configuration for subsequent power up cycles: LF0, DC0, RO0. In addition to initializing all the variables (except password) to the default state, SYST:SEC:IMM clears the SAV setup area and performs a PACK of the memory partitions (see PAR. 4.7.4).

Saving LF1 means that the unit will provide a line feed if the buffer is empty and a read is performed. Saving LF0 means that each string sent to the GPIB port causes a null string to be transmitted. The null string is a single Line feed character. This command is useful during program debug as a read without a query will not hold up the bus.

Saving DC0 means that DCL and SDC have no effect on the device (power supply) except to clear internal status registers. Saving DC1 means that DCL and SDC commands will function the same as the *RST command: the output is set to 0 Volts, 0 Amperes, voltage mode is selected and the output is set to OFF (unless RO1 is also set).

Saving RO0 causes the *RST command to set the output to 0 Volts and 0 Amps and sets output to OFF, requiring an OUTP ON command to be sent before voltage/current commands are present at the output. Saving RO1 causes *RST to set the output to ON and sets the output to 0 Volts and 0 Amps. Subsequent VOLT and CURR commands affect the output directly without having to send OUTP ON. The OUTP ON and OUTP OFF commands function normally to turn the output on and off.

4.7.4 FLASH MEMORY EEPROM OPERATION

The unit's configuration, voltage and current, saved setups (*SAV and *RCL command) and Calibration values are stored in Flash Memory. Since the Flash EEPROM cannot be modified by writing a single data byte, the block must be erased and then the data written into the correct locations.

The Bit 4886 card accomplishes this by partitioning the Flash memory. As the amount of Flash memory used becomes larger with each subsequent data update, the Flash memory can fill up and needs to be compressed. The compression of the Flash EEPROM, called packing, is automatically handled by the BIT 4886 microprocessor's code. The packing process can take a half a second to accomplish. Because it is automatically executed, it can occur after any *SAV, Memory:UPDATE, or save of Calibration. When the memory is out of space, the internal microprocessor copies the live data to a backup flash area, erases the main flash data area, copies the current control variables into this clean space and then erases the backup flash area. The pack process can take 500 milliseconds to complete. Packing is automatically invoked during power up initialization if the BIT 4886 card finds that any storage area is over 90% utilized.

The following statistics are a guide as to when a MEMORY PACK will occur.

- Save area - Approximately 300 *SAV operations can be completed before a PACK will occur automatically.
- Variable area - around 30 updates can be completed prior to an automatic PACK occurring. Variable areas also include serial number updates and password updates.
- Calibration - 16 calibrations can be saved before a PACK is required.

If the memory is over 80% full, the user can also initiate packing by sending the command MEMORY:PACK. Issuing a MEMORY:PACK command if the memory is less than 80% full will have no effect. Because this command may take a long time to complete, it is recommended that the user send MEMORY:PACK;*OPC?. The computer can then perform serial polls to wait for the command to complete. The command will be complete when the serial poll byte indicates there is data in the output buffer. (bit 4 set in the returned status byte).

TABLE 4-5. ENHANCED OPERATION - ERROR RESPONSE

COMMAND	QUERY	DESCRIPTION
DIAG:ERR:CURR xx (xx =hex values from 00 to FF)	DIAG:ERR:CURR?	Allows both current protect and current limit functionality. Bit 7 - when set will establish a fixed Current Limit level when output is ON. Bit 6 - when set enables the current protection error logic. Bit 5 - when set enables Current Protect error bit in ESR/ESE register Bit 4 - when set causes the power up and reset state of the ESE register to be as follows: ESE - 72 if bit 5 set, 8 if not set. Bit 3 - when set allows a current protect error to create an error message of "303 - Current above Protection limit." Bit 2 - when set causes a current protect error to set the output to off. Bit 1 - when sets allows a current measurement in current mode to generate a "Device Error" message. Bit 0 - when set enables a current measurement error in current mode to shut down unit. The query provides one byte which indicates the current limit setting.
DIAG:ERR:VOLT xx (xx =hex values from 00 to FF)	DIAG:ERR:VOLT?	Allows voltage protect and voltage limit functionality. Bit 7 - when set establishes a fixed Voltage Limit level when output is ON. Bit 6 - when set enables the voltage protection error logic. Bit 3 - when set allows a voltage protect error to create an error message of "304 - Voltage above Protection limit" Bit 2 - when set causes a voltage protect error to set the output to off. Bit 1 - when set allows a voltage measurement error in voltage mode to generate a "Device Error" message. Bit 0 - when set allows voltage "device error" message (see bit 1) to set the output to off. The query provides one byte which indicates the voltage limit setting.
DIAG:OFFLimit:CURR xx (xx = decimal value)	DIAG:OFFLimit:CURR?	The decimal value allows the user to establish the actual current limit DAC (digital to analog converter) setting when the output is off and the unit is in voltage mode. This variable is only used when bit 4 of the DIAG:OUTP register is set. The value is calculated using the equation: $\text{Current expected} / (\text{Current max} * 1.1) * 256.$ The DVS standard setting is 128 derived from $(1.1 / 2.2) * 256.$ The query provides one byte which indicates the actual DAC current limit setting.

TABLE 4-5. ENHANCED OPERATION - ERROR RESPONSE (CONTINUED)

COMMAND	QUERY	DESCRIPTION
DIAG:OFFLimit:VOLT xx (xx = decimal value)	DIAG:OFFLimit:VOLT?	The decimal value allows the user to establish the actual voltage limit DAC (digital to analog converter) setting when the output is off and the unit is in current mode. This variable is only used when bit 3 of the DIAG:OUTP register is set. The value is calculated using the equation: $\text{Voltage expected} / \text{Voltage max} * 1.1) * 256$ The DVS standard setting is 0. The query provides one byte which indicates the actual DAC current limit setting.
DIAG:ONLimit:CURR xx (xx = decimal value)	DIAG:ONLimit:CURR?	The decimal value allows the user to establish the actual current limit DAC (digital to analog converter) setting when the output is on and the unit is in voltage mode. This variable is only used when bit 7 of the DIAG:ERR:CURR register is set. The value is calculated using the equation: $\text{Current expected} / (\text{Current max} * 1.1) * 256.$ The DVS standard setting is 128 derived from $(1.1 / 2.2) * 256$. The query provides one byte which indicates the actual DAC current limit setting.
DIAG:ONLimit:VOLT xx (xx = decimal value)	DIAG:ONLimit:VOLT?	The decimal value allows the user to establish the actual voltage limit DAC (digital to analog converter) setting when the output is on and the unit is in current mode. This variable is only used when bit 7 of the DIAG:ERR:VOLT register is set. The value is calculated using the equation: $\text{Voltage expected} / \text{Voltage max} * 1.1) * 256$ The DVS standard setting is 0. The query provides one byte which indicates the actual DAC current limit setting.
DIAG:OUTP n (n = hex character)	DIAG:OUTP? (Returns hex character)	DIAG:OUTP n controls the limit DAC values when the output is set to OFF. The values can either be set to maximum or to a user determined limit value (using the DIAG:OFFLimit commands. The SYST:SEC:IMM command sets DIAG:OUTP n = 0. DIAG:OUTP 0 = the default. This sets both voltage and current limit channels to 0 when the output is off. The four bits of the hex character are defined as follows: Bit 0 = 1 sets voltage limit to maximum when in Voltage mode and the output is off. Bit 1 = 1 sets current limit to maximum when in Current mode and the output is off. Bit 2 = 1 sets voltage limit to value determined by the DIAG:OFFLimit:VOLT command when the output is off. Bit 3 = 1 sets current limit to value determined by the DIAG:OFFLimit:CURR command when the output is off. For example, DIAG:OUTP 3 = sets both voltage and current limit to maximum. This can be useful for battery applications where the limit channel can allow the battery to discharge the battery voltage. Using both the maximum and DIAG:OFFLimit options (e.g., bits 0 and 2) at the same time is not recommended - the maximum value overrides the DIAG:OFFLimit setting.
DIAG:SAV	n/a	DIAG:SAV stores variables established by SYST:SET. (See PAR. 4.7.3 and B.82.)
DIAG:WIN xx (xx = hex value from 10 to 40) ¹	DIAG:WIN? (Returns window value xx (hex))	Allows user to specify value in LSB's for error window used for detection of output voltage or output current measurement errors (default = 32). Error window value can only be set between 16 (10 Hex) and 64 (40 Hex) using one two-digit hex character (xx) ¹ . Query returns 2-digit hex character xx.

TABLE 4-5. ENHANCED OPERATION - ERROR RESPONSE (CONTINUED)

COMMAND	QUERY	DESCRIPTION
DIAG:LEADING xx (xx is the time in half milliseconds increments) (hex)	DIAG:LEADING? returns xx (hex), the time in half milliseconds increments)	<p>xx establishes max dwell time for a two-step list. If the dwell time DD for the two-step list exceeds xx, a step is inserted with voltage = 0V for (DD - xx). MSTs default = 50.</p> <p>Consider the following:</p> <p>LIST:VOLT 0,5 Two step list, 0V then 5V. LIST:DWEL .05 Dwell time of 50 ms LIST:COUNT 0 Repeat continuously. OUTP ON Output enabled. VOLT:MODE LIST Run program</p> <p>The above list would normally produce a continuous square wave, 50ms at 0V, 50ms at 5V (Fig A). If DIAG:LEADING 50 (40 ms) is issued, the square wave changes to 60ms at 0V, 40ms at 5V as follows: the first 1/2 cycle = 50ms at 0V, the second 1/2 cycle = 40ms (the limit set by DIAG:LEADING) at 5V, then 10ms (50 - 40 = 10) at 0V (Fig B). If LIST:VOLT 0,5 is changed to LIST:VOLT -5,5 both 1/2 cycles will show 10ms steps at 0V (Fig C).</p> <p>3042752</p>

1 The default window value of 32 indicates a 32 LSB margin for error during readback. The value for Readback is arrived at by taking 16 samples of voltage or current and averaging them. A readback error is produced when the calculated readback value (with calibration constants applied) exceeds the maximum readback (calculated readback + error window) or minimum readback (calculated readback - error window). Increasing the error window can avoid undesired errors. For example, in cases where the LIST command is used to produce a square wave output, overshoot inherent in the characteristics of the power supply can sometimes cause the readback average to increase enough to cause a readback error. Increasing the error window allows the square wave to be generated without producing an error.

4.7.4.1 CALIBRATION STORAGE

The BIT 4886 maintains the calibration tables in Flash Memory until a PACK is executed. There are six calibration areas maintained in Flash Memory: Working, Prior, Oldest, Factory, Master, and First.

The calibration can be copied to another area using the CAL:COPY command. The syntax is as follows: CAL:COPY (source) (destination) where (source) and (destination) refer to the areas of Flash memory where calibration data is stored, designated as: WORKing, PRIor, OLDest, FAC-Tory, MASTer, FIRst. Source refers to the calibration area that is to be copied, destination to the area that the calibration will be copied into.

The Master calibration should never be overwritten. Factory, Master, and First are set to the same values when a BIT 4886 card is factory-installed in a BOP power supply. The Working calibration is the active calibration. Each time a CAL:SAV is executed, the values are saved in the Working (active) area. At the same time, the values previously stored in Working are moved to Prior, and the values previously stored in Prior are moved to Oldest. The values previously stored in Oldest are no longer available. Table 4-6 illustrates calibration storage and the use of the CAL:COPY command. An example is shown in PAR. 4.2

TABLE 4-6. CALIBRATION STORAGE

COMMAND	WORKing	PRior	OLDest	FACTory	MASTer	FIRst
1. CAL:SAVE	Cal 1 values			factory cal.	Master cal.	First cal.
2. CAL:SAVE	Cal 2 values	Cal 1 values		No Change	No Change	No Change
3. CAL:SAVE	Cal 3 values	Cal 2 values	Cal 1 values	No Change	No Change	No Change
4. CAL:SAVE	Cal 4 values	Cal 3 values	Cal 2 values	No Change	No Change	No Change
5. CAL:COPY FACTory WORKing	factory cal.	Cal 4 values	Cal 3 values	No Change	No Change	No Change
6. CAL:COPY PRior WORKing	Cal 4 values	factory cal.	Cal 4 values	No Change	No Change	No Change

APPENDIX A - SCPI COMMON COMMAND/QUERY DEFINITIONS

A.1 INTRODUCTION

This appendix defines the SCPI common commands and queries used with the BIT 4886 Interface Card. Common commands and queries are preceded by an asterisk (*) and are defined and explained in paragraphs A.2 through A.18, arranged in alphabetical order. Table A-1 provides a quick reference of all SCPI common commands and queries used in the Interface Card.

TABLE A-1. IEEE 488.2 COMMAND/QUERY INDEX

COMMAND	PAR.	COMMAND	PAR.
*CLS	A.2	*RST	A.11
*ESE, ?	A.3, A.4	*SAV	A.12
*ESR?	A.5	*SRE, ?	A.13, A.14
*IDN?	A.6	*STB?	A.15
*OPC, ?	A.7, A.8	*TRG	A.16
*OPT?	A.9	*TST?	A.17
*RCL	A.10	*WAI	A.18

A.2 *CLS — CLEAR STATUS COMMAND

***CLS**

Syntax: *CLS

Description: **Clears status data.** Clears the error queue of the instrument. Forces power supply to “operation complete idle” and “operation complete query” state. Clears all Event Registers summarized in Status Byte Register without affecting the corresponding Enable Registers: Standard Event Status Register (ESR), Operation Status Event Register, Questionable Status Event Register, and Status Byte Register (STB). Related commands: *OPC *OPC?. (See example, Figure A-1.)

A.3 *ESE — STANDARD EVENT STATUS ENABLE COMMAND

***ESE**

Syntax: *ESE <integer> where <integer> = positive whole number: 0 to 255 per Table A-2.
Default Value: 0

Description: **This command programs the standard Event Status Enable register bits.** The contents function as a mask to determine which events of the Event Status Register (ESR) are allowed to set the ESB (Event Summary Bit) of the Status Byte Register. Enables the Standard events to be summarized in the Status Byte register (1 = set = enable function, 0 = reset = disable function). All of the enabled events of the standard Event Status Enable register are logically ORed to cause ESB (bit 5) of the Status Byte Register to be set (1 = set = enable, 0 = reset = disable). (See example, Figure A-1.)

TABLE A-2. STANDARD EVENT STATUS ENABLE REGISTER AND STANDARD EVENT STATUS REGISTER BITS

CONDITION	NU	NU	CME	EXE	DDE	QUE	NU	OPC
BIT	7	6	5	4	3	2	1	0
VALUE	128	64	32	16	8	4	2	1

NU (Not Used)
 CME Command Error
 EXE Execution Error
 DDE Device Dependent Error
 QUE Query Error
 OPC Operation Complete

*ESE?

A.4 *ESE? — STANDARD EVENT STATUS ENABLE QUERY

Syntax: *ESE? Return value: Integer> value per Table A-2.

Description: **Returns the mask stored in the Standard Event Status Enable Register.** Contents of Standard Event Status Enable register (*ESE) determine which bits of Standard Event Status register (*ESR) are enabled, allowing them to be summarized in the Status Byte register (*STB). All of the enabled events of the Standard Event Status Enable Register are logically ORed to cause ESB (bit 5) of the Status Byte Register to be set (1 = set = enable function, 0 = reset = disable function). (See example, Figure A-1.)

*ESR?

A.5 *ESR? — EVENT STATUS REGISTER QUERY

Syntax: *ESR?
Return value: <integer> (Value = contents of Event Status register as defined in Table A-2.)

Description: **Causes the power supply to return the contents of the Standard Event Status register. After it has been read, the register is cleared.** The Standard Event Status register bit configuration is defined in Table A-2 (1 = set, 0 = reset). The error bits listed in Table A-2 are also related to error codes produced during parsing of messages and to errors in the power supply (see PAR. B.80)

- Any 1xx type error sets the Command error bit (5) see.
- Any 2xx type error sets the Execution error bit (4).
- Any 3xx type error sets the Device error bit (3). The Device error bit will be set when Current Error or Voltage Error is detected and the corresponding Status Questionable bit is set (see PAR. B.28).
- Any 4xx type error sets the Query error bit (2).

Related Commands: *CLS, *ESE, *OPC. (See example, Figure A-1.)

*IDN?

A.6 *IDN? — IDENTIFICATION QUERY

Syntax: *IDN?
Return value: Character string

Description: **Identifies the instrument.** This query requests identification. The power supply returns a string which contains the manufacturer name, the model, the serial number and the firmware level. The character string contains the following fields: <Manufacturer>, <Model>, <Voltage>, <Current>, <Serial Number>, <Main revision>-<Flash revision> where: <Manufacturer> = KEPCO, <Model> = BIT 4886, <Serial Number> = SSSSSS <date> = (see CAL:SAVE DATE, PAR. B.11) <Main revision>=n.m, e.g, 1.0) ><Firmware revision>=n.m (n.m revision, e.g, 1.0) (See example, Figure A-1.)

*OPC

A.7 *OPC — OPERATION COMPLETE COMMAND

Syntax: *OPC

Description: **Causes power supply to set status bit 0 (Operation Complete) when pending operations are complete** This command sets Standard Event Status Register bit 0 (see Table A-2) to "1" when all previous commands have been executed and changes in output level have been completed. This command does not prevent processing of subsequent commands, but bit 0 will not be set until all pending operations are completed. (1 = set = enable function, 0 = reset = disable function). (See example, Figure A-1.) As an example, the controller sends command(s), then sends *OPC. If controller then sends *ESR?, the power supply responds with either a "0" (if the power supply is busy executing the programmed commands), or a "1" (if the previously programmed commands are complete). (See example, Figure A-1.)

*OPC?

A.8 *OPC? — OPERATION COMPLETE QUERY

Syntax: *OPC?

Return value: <1> (ASCII) placed in output queue when power supply has completed operation.

Description: **Indicates when pending operations have been completed.** When all pending operations are complete (all previous commands have been executed and changes in output level have been completed) a "1" is placed in the Output Queue. Subsequent commands are inhibited until the pending operations are completed. *OPC? is intended to be used at the end of a command line so that the application program can monitor the bus for data until it receives the "1" from the power supply Output Queue. (See example, Figure A-1.)

*CLS	Power supply clears status data.
*ESE 60	Power supply enables bits 5, 4, 3 and 2, allowing command error, execution error, device dependent error and query error to set the Event Status Summary bit when an STB command is executed.
*ESE?	Returns 60, (value of the mask) verifying that bits 5, 4, 3 and 2 are enabled.
*ES	Unknown command will set command error (Bit 5).
*ESR?	Returns 32 (bit 5 set), indicating Command Error has occurred since the last time the register was read.
*IDN?	Power supply returns: KEPCO, BIT 4886 100-2 123456 1.8-1.8
*OPC	Allows status bit 0 to be set when pending operations complete
VOLT 21;CURR 3	Sets output voltage to 21V, output current to 3A
*ESR?	Returns 129 (128 + 1, power on, bit 7 = 1, operation complete, bit 1 = 1)
*ESR?	Returns 0 (event status register cleared by prior *ESR?)
VOLT 15;CURR 5;*OPC?	Sets output voltage to 15V, output current to 5A, puts "1" on output bus when command operations are complete.
*RST	Power supply reset to power on default state.
*SRE 40	When ESB or QUES bits are set (Table A-3), the Request for Service bit will be set.
*SRE?	Returns the value of the mask (40).
*STB?	For example, the Power supply responds with 96 (64 + 32) if MSS and the Event Status Byte (Table A-3) summary bit have been set. The power supply returns 00 if no bits have been set.
VOLT 25	Power supply voltage commanded to 25V.
VOLT:TRIG 12	Programs power supply voltage to 12V when *TRG received.
INIT	Trigger event is initialized.
*TRG	Power supply reverts to commanded output voltage of 12V. ** LOAD DISCONNECTED
*TST?	Power supply executes self test and responds with 0 if test completed successfully, with 1 if test failed.

FIGURE A-1. GPIB COMMANDS

*OPT?

A.9 *OPT? — OPTIONS QUERY

Syntax: *OPT?
Returns string determined by power supply model.

Description: **Causes the power supply to return an ASCII string which defines the functionality of the power supply.** The functionality is defined as follows:

STRING DATA	MEANING
CAL	Support for CALibrate is present.
RL1	Commands sent over GPIB cause unit to enter remote mode (except for MEASure).
MEM	Indicates the number of memory steps supported.
LST	Indicates the number of LIST steps supported.

*RCL

A.10 *RCL — RECALL COMMAND

Syntax: *RCL <integer> (1 to 99)

Description: **Restores power supply to previously defined levels of output voltage, output current and triggers.** This command selects one of the 99 power supply memory locations, each of which stores values for output current, and output voltage and trigger levels. Executing a *RCL recalls the previously defined trigger settings from memory and places them in the trigger control section of the BIT 4886. Executing a second *RCL will cause the values in the trigger control section to be moved to the bit 4886 output channel, allowing the power supply to operate with the recalled trigger information. The following parameters are affected by *RCL: VOLT:TRIG, CURR:TRIG, and FUNC:MODE:TRIG.

*RST

A.11 *RST — RESET COMMAND

Syntax: *RST

Description: **Resets power supply to the power on default state.** The power supply output set to off (see DIAG:OUTP, Table 4-5, to establish the “off” state parameters) and the power supply is programmed to the power on values of the following parameters: CURR[:LEV][:IMM] = 0, VOLT[:LEV][:IMM] = 0, MODE = VOLT. If the power supply is in either an overvoltage or overcurrent state, this condition is reset by *RST. After sending *RST it is necessary to send OUTPUT ON for programmed values to appear at the output. The *RST command always returns the mode to Voltage and the range to automatic.(See example, Figure A-1.)

*SAV

A.12 *SAV — SAVE COMMAND

Syntax: *SAV <integer> (1 to 99)

Description: **Saves the present state of output voltage, output current and trigger values, to the specified memory location.** This command stores the present state of the power supply to one of 99 memory locations in Flash Memory (see PAR. 4.7.4). The following parameters are stored by *SAV: VOLT:TRIG, CURR:TRIG, and FUNC:MODE:TRIG. The stored values can be restored by the *RCL command.

*SRE

A.13 *SRE — SERVICE REQUEST ENABLE COMMAND

Syntax: *SRE<integer> where <integer> = value from 0 - 255 per Table A-3, except bit 6 cannot be programmed.

Description: **Sets the condition of the Service Request Enable register.** The Service Request Enable register determines which events of the Status Byte Register are summed into the MSS (Master Status Summary) and RQS (Request for Service) bits. RQS is the service request bit that is cleared by a serial poll, while MSS is not cleared when read. A “1” (1 = set = enable, 0 = reset = disable) in any Service Request Enable register bit position enables the corresponding Status Byte bit to set the RQS and MSS bits. All the enabled Service Request Enable register bits then are logically ORed to cause Bit 6 of the Status Byte Register (MSS/RQS) to be set. Related Commands: *SRE?, *STB?. (See example, Figure A-1.)

TABLE A-3. SERVICE REQUEST ENABLE AND STATUS BYTE REGISTER BITS

CONDITION	OPER	MSS RQS	ESB	MAV	QUES	ERR QUE	NU	NU
BIT	7	6	5	4	3	2	1	0
VALUE	128	64	32	16	8	4	2	1

OPER Operation Status Summary
MSS Master Status Summary
RQS Request for Service
ESB Event Status Byte summary
MAV Message available
QUES QUEStionable Status Summary
ERR QUE 1 or more errors occurred (see
 PAR. B.80)
NU (Not Used)

A.14 *SRE? — SERVICE REQUEST ENABLE QUERY

***SRE?**

Syntax: *SRE? Response: <integer> = value from 0 - 255 per Table A-3.

Description: **Reads the Service Enable Register.** Used to determine which events of the Status Byte Register are programmed to cause the power supply to generate a service request (1 = set = function enabled, 0 = reset = function disabled). Related Commands: *SRE, *STB? (See example, Figure A-1.)

A.15 *STB? — STATUS BYTE REGISTER QUERY

***STB?**

Syntax: *STB? Response: <integer> value from 0 to 255 per Table A-3.

Description: **Reads Status Byte Register without clearing it.** This Query reads the Status Byte Register (bit 6 = MSS) without clearing it (1 = set = function enabled, 0 = reset = function disabled). The register is cleared only when subsequent action clears all set bits. MSS is set when the power supply has one ore more reasons for requesting service. (A serial poll also reads the Status Byte Register, except that bit 6 = RQS, not MSS; and RQS will be reset.) Related Commands: *SRE, *SRE?. (See example, Figure A-1.)

A.16 *TRG — TRIGGER COMMAND

***TRG**

Syntax: *TRG

Description: **Triggers the power supply to be commanded to preprogrammed values of output current and voltage.** When the trigger is armed (checked by examining WTG bit in Status Operational Condition register), *TRG generates a trigger signal. The trigger will change the output of the power supply to the output voltage and current levels specified by VOLT:TRIG and CURR:TRIG commands and clear the WTG bit in the Status Operation Condition register. If INIT:CONT has been issued, the trigger subsystem is immediately rearmed for subsequent triggers, and the WTG bit is again set to 1. *TRG or GET are both addressed commands (only devices selected as listeners will execute the command). Related Commands: ABOR, INIT, TRIG, CURR:TRIG, VOLT:TRIG. (See example, Figure A-1.)

A.17 *TST? — SELF TEST QUERY

***TST?**

Syntax: *TST? Returned value: 0 or non-zero (0 = pass test, non-zero = fail test)

Description: **Power Supply test.** This query causes the power supply to do a self test and provide the controller with pass/fail results. A 0 is returned if the unit passes the test. If the unit fails, a number is returned to indicate the cause of the error. The test executes each of the subtests even when any one fails. If any test fails an error code bit is set which is returned to the user. The error codes returned are listed in Table 4-1.

A.18 *WAI — WAIT-TO-CONTINUE COMMAND

***WAI**

Syntax: *WAI Response:

Description: **Causes the power supply to wait until all previously issued commands and queries are complete before executing subsequent commands or queries.** This command can be used to guarantee sequential execution of commands and queries. When all pending operations are complete (all previous commands have been executed, changes in output level have been completed), the WAI command is completed and execution of subsequent commands can continue.

APPENDIX B - SCPI COMMAND/QUERY DEFINITIONS

B.1 INTRODUCTION

This appendix defines the SCPI subsystem commands and queries used with the BIT 4886 Interface Card. Subsystem commands are defined in PAR. B.4 through B.92, arranged in groups as they appear in the tree diagram, Figure 4-5. Table B-1 provides a quick reference of all SCPI subsystem commands and queries used in the Interface Card.

TABLE B-1. SCPI SUBSYSTEM COMMAND/QUERY INDEX

COMMAND	PAR.	COMMAND	PAR.
CAL:CPR	B.3	[SOUR:]LIST:VOLT:POIN?	B.47
CAL:STAT, ?	B.4, B.5	[SOUR]:CURR, ?	B.48, B.49
CAL:CURR	B.6	[SOUR]:CURR:MODE, ?	B.50, B.51
CAL:DATA	B.7	[SOUR]:CURR:RANG, ?	B.52, B.53
CAL:DPOT	B.8	[SOUR]:CURR:RANG:AUTO	B.54
CAL:LCURR	B.9	[SOUR]:CURR:TRIG?	B.55, B.56
CAL:LVOLT	B.10	[SOUR]:VOLT	B.57, B.58
CAL:SAVE	B.11	[SOUR]:VOLT:MODE, ?	B.59, B.60
CAL:VOLT	B.12	[SOUR]:VOLT:RANG, ?	B.61, B.62
CAL:VPR	B.13	[SOUR]:VOLT:RANG:AUTO	B.63
CAL:ZERO	B.14	[SOUR]:VOLT:TRIG	B.64, B.65
INIT[:IMM]	B.15	STAT:OPER:COND?	B.66
INIT:CONT, ?	B.16, B.17	STAT:OPER:ENAB, ?	B.67, B.68
MEAS:CURR?	B.18	STAT:OPER[:EVEN]?	B.69
MEAS:VOLT?	B.19	STAT:PRES	B.70
OUTP[:STAT], ?	B.20, B.21	STAT:QUES[:EVEN]?	B.71
[SOUR:]FUNC:MODE, ?	B.22, B.23	STAT:QUES:COND?	B.72
[SOUR:]FUNC:MODE:TRIG, ?	B.24, B.25	STAT:QUES:ENAB, ?	B.73, B.74
[SOUR:]LIST:CLE	B.26	SYST:BEEP	B.75
[SOUR:]LIST:COUN, ?	B.27, B.28	SYST:COM:SER:ECHO, ?	B.76, B.77
[SOUR:]LIST:COUN:SKIP, ?	B.29, B.30	SYST:COM:SER:PACE, ?	B.78, B.79
[SOUR:]LIST:CURR, ?	B.31, B.32	SYST:ERR?	B.80
[SOUR:]LIST:POIN?	B.33	SYST:ERR:CODE?	B.81, B.82
[SOUR:]LIST:DIR, ?	B.34, B.35	SYST:PASS CEN, CDIS	B.83, B.84
[SOUR:]LIST:DWEL, ?	B.36, B.37	SYST:PASS:STAT	B.86
[SOUR:]LIST:DWEL:POIN?	B.38	SYST:REM, ?	B.87, B.88
[SOUR:]LIST:GEN, ?	B.39, B.40	SYST:SEC	B.89
[SOUR:]LIST:QUER, ?	B.41, B.42	SYST:SET, ?	B.90, B.91
[SOUR:]LIST:SEQ, ?	B.43, B.44	SYST:VERS?	B.92
[SOUR:]LIST:VOLT, ?	B.45, B.46		
NOTE: Commands listed above that are followed by *, "?" have a related query.			

B.2 NUMERICAL VALUES

The SCPI data parser on the BIT 4886 supports a maximum of 8 digits after the decimal point and a maximum integer of 4×10^8 . Any values greater than these are not processed by the device and no error is generated. The largest string that can be received or transmitted by the BIT 4886 is 253 characters.

All numerical data is returned in scientific notation, digits with decimal point and Exponent, e.g., 2.71E1 for 27.1 after calibration constants have been applied. Thus, for example, VOLT 14;VOLT? may return 1.39997E1 which indicates that the unit has been calibrated to provide 13.9997V for a programmed value of 14V, within the calculation accuracy of the BIT 4886. Error “-120” results from syntactical errors, e.g., the exponent exceeds 8, a letter is identified, etc. Error “-222” is produced if the value exceeds the range of acceptable values for the parameter.

B.3 CALibrate:CPRotect COMMAND

CAL:CPR

Syntax: Short Form: CAL:CPR {MIN | MAX}
Long Form: CALibrate:CPRotect {MIN | MAX}

Description: **Selects Current Protection limit calibration, only effective with power supply in Calibrate status.** CAL:CPR MAX selects maximum positive current protection limit calibration. CAL:CPR MIN selects maximum negative current protection limit calibration. **Related Commands:** CAL:STAT, CAL:ZERO, CAL:DATA, CAL:SAVE.

B.4 CALibrate:STATus COMMAND

CAL:STAT

Syntax: Short Form: CAL:STAT <boolean>
Long Form: CALibrate:STATus <boolean>
where boolean = 0 or OFF, 1 or ON

Description: **Sets the power supply to Calibrate status.** <boolean> 1 or ON causes power supply to enter Calibrate status. <boolean> 0 or OFF causes power supply to exit Calibrate status. If the wrong password was not enabled, error message -224 is posted to the queue. **Related Commands:** CAL:STAT, CAL:VOLT, CAL:CURR, CAL:ZERO, CAL:DATA, CAL:DPOT, CAL:SAVE. (See example, Figure B-1.)

B.5 CALibrate[:STATus]? QUERY

CAL[:STAT]?

Syntax: Short Form: CAL:STAT? Long Form: CALibrate:STATus?
Return Value: <DATA>

where DATA = ZERO-ZERO, VOLT-ZERO, VOLT-MAX, VOLT-MIN, CURR-ZERO, CURR-MAX, CURR-MIN, or OFF.

Description: **Identifies whether the power supply is in Calibrate status and indicates which calibration step is active.** OFF indicates power supply is not in Calibrate status. ZERO-ZERO indicates power supply is at 0V, 0A, waiting for connection of load resistor. VOLT-ZERO indicates zero offset voltage adjustment is active. VOLT-MAX indicates maximum voltage adjustment is active. VOLT-MIN indicates minimum (negative) voltage adjustment is active. CURR-ZERO indicates zero offset current adjustment is active. CURR-MAX indicates maximum current adjustment is active. CURR-MIN indicates minimum (negative) current adjustment is active. **Related Commands:** CAL:STAT, CAL:VOLT, CAL:CURR, CAL:ZERO, CAL:DATA, CAL:DPOT, CAL:SAVE. (See example, Figure B-1.)

SYST:PASS:CEN 1234	If password set to 1234, enables commands requiring password.
CAL:STAT 1	Power supply enters Calibrate status.
CAL:STAT?	Returns ZERO-ZERO indicating power supply in Calibrate status.
CAL:VOLT ZERO	Voltage Zero Calibration selected.
CAL:VOLT MAX	Voltage positive Calibration selected.
CAL:DPOT 1	Output voltage increased by 10 LSB.
CAL:VOLT MIN	Voltage negative Calibration selected.
CAL:DATA -2	Output voltage decreased by 2 LSBs.
CAL:ZERO	Output voltage and current set to zero.
---	* User connects shunt and connects DVM to output.
CAL:CURR ZERO	Current Zero Calibration selected.
CAL:DPOT -1	Output current decreased by 10 LSB.
CAL:CURR MIN	Current negative Calibration selected.
CAL:DPOT 1	Output current increased by 10 LSB.
CAL:CURR MAX	Current positive Calibration selected.
CAL:DATA -1	Output current decreased by 1 LSB.
CAL:SAVE	Calibration values saved.
CAL:STAT 0	Power supply exits Calibrate mode.
CAL:STAT?	Returns 0 indicating power supply not in Calibrate status
---	* User disconnects shunt and DVM.

FIGURE B-1. USING CALIBRATION COMMANDS AND QUERIES

B.6 CALibrate:CURRENT COMMAND

CAL:CURR

Syntax: Short Form: CAL:CURR {MIN | MAX | ZERO}
 Long Form: CALibrate:CURR {MIN | MAX | ZERO}

Description: **Selects Current calibration, only effective with power supply in Calibrate status.**
 CAL:CURR ZERO selects Current Zero Calibration. CAL:CURR MIN selects Current Full Scale Negative Calibration. CAL:CURR MAX selects Current Full Scale Positive Calibration. Normally Current Zero is done first, then Current Full Scale Positive Calibration. **Related Commands:** CAL:STAT, CAL:VOLT, CAL:CURR, CAL:ZERO, CAL:DATA, CAL:DPOT, CAL:SAVE. (See example, Figure B-1.)

B.7 CALibrate:DATA COMMAND

CAL:DATA

Syntax: Short Form: CAL:DATA {N} Long Form: CALibrate:DATA {N}

Description: **Provides fine adjustment of output during calibration only; Increases or decreases output by N LSB's.** CAL:CURR -N decreases output by N LSBs. CAL:CURR N increases output by N LSBs. This command is used during calibration to adjust the output for zero calibration as well as full scale calibration. This command is only effective if Calibration status is active. **Related Commands:** CAL:STAT, CAL:VOLT, CAL:LVOLT, CAL:LCURR, CAL:CURR, CAL:DPOT, CAL:ZERO, CAL:SAVE. (See example, Figure B-1.)

B.8 CALibrate:DPOT COMMAND

CAL:DPOT

Syntax: Short Form: CAL:DPOT {N} Long Form: CALibrate:DPOT {N}

Description: **Provides coarse adjustment of the output during calibration to within 5% of maximum and 2% of nominal; increases or decreases output by 50 LSB increments.** Acceptable values of N are within ±32, corresponding to ±1600 (50 x 32) LSB's. CAL:DPOT -N decreases output voltage by N LSBs. CAL:VOLT N increases output voltage by N LSBs. This command is used during calibration to adjust the output for Zero calibration as well as Full Scale Positive calibration. Output voltage is monitored on a calibrated digital multimeter and increased or decreased as required using this command. Output current is monitored on a calibrated digital multimeter (reading voltage at the sense terminals of the shunt resistor) and increased or decreased as required using this command. This command is only effective if Calibration status and either Voltage Zero, Voltage Maximum. Current Zero or Current Maximum calibration are active. CAL:STAT, CAL:VOLT, CAL:LVOL, CAL:VOLT, CAL:CURR, CAL:DATA, CAL:ZERO, CAL:SAVE. (See example, Figure B-1.)

B.9 CALibrate:LCURR COMMAND

CAL:LCURR

Syntax: Short Form: CAL:LCURR {MIN | MAX | ZERO}
Long Form: CALibrate:LCURR {MIN | MAX | ZERO}

Description: **Selects low current range (1/4 scale) Current calibration, only effective with power supply in Calibrate status.** CAL:LCURR ZERO selects Low Current Range Zero Calibration. CAL:LCURR MIN selects Low Current Range Full Scale Negative Calibration. CAL:LCURR MAX selects Low Current Range Full Scale Positive Calibration. Normally Low Current Range Zero is done first, then Low Current Range Full Scale Positive Calibration. **Related Commands:** CAL:STAT, CAL:VOLT, CAL:CURR, CAL:ZERO, CAL:DATA, CAL:DPOT, CAL:SAVE. (See example, Figure B-1.)

B.10 CALibrate:LVOLT COMMAND

CAL:LVOLT

Syntax: Short Form: CAL:LVOLT {MIN | MAX | ZERO}
Long Form: CALibrate:LVOLT {MIN | MAX | ZERO}

Description: **Selects low voltage range (1/4 scale) Voltage calibration, only effective with power supply in Calibrate status.** CAL:LVOLT ZERO selects Low Voltage Range Zero Calibration. CAL:LVOLT MIN selects Low Voltage Range Full Scale Negative Calibration. CAL:LVOLT MAX selects Low Voltage Range Full Scale Positive Calibration. Normally Low Voltage Range Zero is done first, then Low Voltage Range Full Scale Positive Calibration. **Related Commands:** CAL:STAT, CAL:VOLT, CAL:CURR, CAL:ZERO, CAL:DATA, CAL:DPOT, CAL:SAVE. (See example, Figure B-1.)

B.11 CALibrate:SAVE COMMAND

CAL:SAVE

Syntax: Short Form: CAL:SAVE Long Form: CALibrate:SAVE
Short Form: CAL:SAVE DATE <string> Long Form: CALibrate:SAVE DATE <string>
where DATE is optional allowing <string> of up to 12 contiguous characters identifying calibration date to be saved. Active DATE <string> is returned by *IDN? query.

Description: **Saves computed calibration values in non-volatile memory.** This command saves only the calibration values computed after entering Calibration status. If, for example, only Voltage calibration was performed, these are the only values saved. These values are stored in Flash Memory (see PAR. 4.7.4). Previous values are not lost, and can be restored (see PAR. 4.7.4.1). This command should be the last command before exiting Calibrate status. CAL:STAT, CAL:DATA, CAL:DPOT, CAL:VOLT, CAL:CURR, CAL:ZERO. (See example, Figure B-1.)

B.12 CALibrate:VOLTage COMMAND

CAL:VOLT

Syntax: Short Form: CAL:VOLT {MIN | MAX | ZERO}
Long Form: CALibrate:VOLT {MIN | MAX | ZERO}

Description: **Selects Voltage calibration, only effective with power supply in Calibrate status.** CAL:VOLT ZERO selects Voltage Zero Calibration. CAL:VOLT MIN selects Voltage Full Scale Negative Calibration. CAL:VOLT MAX selects Voltage Full Scale Positive Calibration. Normally Voltage Zero is done first, then Voltage Full Scale Positive Calibration. **Related Commands:** CAL:STAT, CAL:VOLT, CAL:CURR, CAL:ZERO, CAL:DATA, CAL:DPOT, CAL:SAVE. (See example, Figure B-1.)

B.13 CALibrate:VPRotect COMMAND

CAL:VPR

Syntax: Short Form: CAL:VPR {MIN | MAX}
Long Form: CALibrate:VPRotect {MIN | MAX}

Description: **Selects Voltage Protection limit calibration, only effective with power supply in Calibrate status.** CAL:VPR MAX selects maximum positive voltage protection limit calibration. CAL:VPR MIN selects maximum negative voltage protection limit calibration. **Related Commands:** CAL:STAT, CAL:ZERO, CAL:DATA, CAL:SAVE.

B.14 CALibrate:ZERO COMMAND

CAL:ZERO

Syntax: Short Form: CAL:ZERO Long Form: CALibrate:ZERO

Description: **Sets output to zero while calibration equipment connections are changed.** This command is used when changing from Voltage to Current calibration or vice-versa. CAL:ZERO sets output voltage and current to zero. The user then connects or disconnects the shunt resistor or the digital voltmeter from the output terminals of the power supply as required for the subsequent Voltage or Current calibration. The next command should select the new parameter to be calibrated. **Related Commands:** CAL:STAT, CAL:VOLT, CAL:CURR, CAL:SAVE. (See example, Figure B-1.)

B.15 INITiate[:IMMEDIATE] COMMAND

INIT[:IMM]

Syntax: Short Form: INIT[:IMM] Long Form: INITiate[:IMMEDIATE]

Description: **Enables a single trigger.** This command enables a single trigger. A *TRG command completes the sequence. Upon receipt of the *TRG command, the power supply will return to the commanded values of voltage and current established by the VOLT:TRIG and CURR:TRIG commands. After a *TRG command has been received, subsequent *TRG commands have no effect unless preceded by INIT or INIT:CONT ON. Related Commands: *TRG, TRIG. (See example, Figure B-4.)

B.16 INITiate:CONTInuous COMMAND

INIT:CONT

Syntax: Short Form: INIT:CONT {ON | OFF} or {1 | 0} (1 = on, 0 = off)
Long Form: INITiate:CONTInuous {ON | OFF} or {1 | 0} (1 = on, 0 = off)

Description: **INIT:CONT ON enables continuous triggers.; INIT:CONT OFF disables continuous triggers.** If INIT:CONT is OFF, then INIT[:IMM] arms the trigger system for a single trigger. If INIT:CONT is ON, then the trigger system is continuously armed and INIT[:IMM] is redundant. Executing *RST command sets INIT:CONT to ON. (See example, Figure B-4.)

B.17 INITiate:CONTInuous QUERY

INIT:CONT?

Syntax: Short Form: INIT:CONT? Long Form: INITiate:CONTInuous?
Return Value: 1 or 0

Description: **Determines whether continuous triggers are enabled or disabled.** Power supply returns value of INIT:CONT flag: "1" = continuous triggers are enabled (INIT:CONT ON); "0" = continuous triggers disabled (INIT:CONT OFF). (See example, Figure B-4.)

B.18 MEASure[:SCALar]:CURRent[:DC]? QUERY

MEAS:CURR?

Syntax: Short Form: MEAS[:SCAL]:CURR[:DC]?
Long Form: MEASure[:SCALar]:CURRent[:DC]?
Return Value: <num_value> (digits with decimal point and Exponent)

Description: **Measures actual current.** This query returns the actual value of output current (measured at the output terminals) as determined by the programmed value of voltage and current and load conditions. (See example, Figure B-4.)

B.19 MEASure[:VOLTage][:SCALar][:DC]? QUERY

MEAS:VOLT?

Syntax: Short Form: MEAS[:SCAL]:VOLT[:DC]?
Long Form: MEASure[:SCALar]:VOLTage[:DC]?
Return Value: <num_value> (digits with decimal point and Exponent)

Description: **Measures actual voltage.** This query returns the actual value of output voltage (measured at the output terminals) as determined by the programmed value of voltage and current and load conditions. (See example, Figure B-4.)

B.20 OUTPut[:STATe] COMMAND

OUTP

Syntax: Short Form: OUTP[:STAT] <boolean> Long Form: OUTPut[:STATe] <boolean>
<boolean>=(0 or OFF, 1 or ON)

Description: **Enables or disables the power supply output.** Upon power up the power supply is in Local mode: the output is always on and the front panel controls affect the unit's operation. Upon entering Remote mode, the default state is OUTP OFF; OUTP ON must be executed to enable the output. When OUTP OFF is executed, the programmed values of voltage and current are saved, then voltage and current are programmed to 0. When OUTP ON is executed, the power supply output is restored to the previously saved programmed values. The saved values of voltage and current can be viewed by VOLT? and CURR? queries. Related Commands: OUTP?.

B.21 OUTPut[:STATe] QUERY

OUTP?

Syntax: Short Form: OUTP[:STAT]? Long Form: OUTPut[:STATe]?
Return Value: <int_value> (0 or 1)

Description: **Indicates whether power supply output is enabled or disabled.** Returns 0 if output disabled, returns 1 if output enabled. Related Commands: OUTP.

B.22 [SOURCE:]FUNCTION:MODE COMMAND

FUNC:MODE

Syntax: Short Form: FUNC:MODE {VOLT | CURR} Long Form: [SOURCE:]FUNCTION:MODE {VOLT | CURR}

Description: **Establishes the operating mode of the power supply.** VOLT = Voltage mode. CURR = Current mode. FUNC:MODE VOLT commands power supply to Voltage mode, FUNC:MODE CURR commands power supply to Current mode. Commanded mode establishes parameters (voltage or current) monitored for error conditions. Actual mode depends upon load conditions. When commanded to Voltage mode, if load conditions cause the power supply to try to exceed the current limit, the unit will flag an error condition. When commanded to Current mode, if load conditions cause the power supply to try to exceed the voltage limit, the unit will flag an error condition. If VOLT:MODE or CURR:MODE is set to TRANS, FUNC:MODE command automatically changes the mode to FIXEd. (See example, Figure B-4.)

B.23 [SOURCE:]FUNCTION:MODE? QUERY

FUNC:MODE?

Syntax: Short Form: FUNC:MODE? Long Form: [SOURCE:]FUNCTION:MODE?

Return value: 0 (voltage mode) or 1 (current mode)

Description: **Returns the operating mode of the power supply.** 0 = Voltage mode. 1 = Current mode.

B.24 [SOURCE:]FUNCTION:MODE:TRIGger

FUNC:MODE:TRIG

Syntax: Short Form: FUNC:MODE:TRIG {VOLT | CURR}
Long Form: [SOURCE:]FUNCTION:MODE:TRIGger {VOLT | CURR}

Description: **Establishes the operating mode of the power supply when a TRIGger command is sent.** VOLT = Voltage mode. CURR = Current mode. This command establishes the operating mode for triggers which is to be saved or recalled using *SAV or *RCL command. FUNC:MODE:TRIG VOLT commands power supply to Voltage mode when a TRIGger command is sent, FUNC:MODE:TRIG CURR commands power supply to Current mode when a TRIGger command is sent. If VOLT:MODE or CURR:MODE is set to TRANS, FUNC:MODE:TRIG command automatically changes the mode to FIXEd. (See example, Figure B-5.)

B.25 [SOURCE:]FUNCTION:MODE:TRIGger? QUERY

FUNC:MODE:TRIG?

Syntax: Short Form: FUNC:MODE:TRIG? Long Form: [SOURCE:]FUNCTION:MODE:TRIGger?

Return value: 0 = voltage mode or 1 = current mode

Description: **Returns the operating mode which the power supply will enter when a trigger command is sent.** VOLT = Voltage mode. CURR = Current mode. (See example, Figure B-5.)

B.26 [SOURCE:]LIST:CLEAr COMMAND

LIST:CLE

Syntax: Short Form: LIST:CLE Long Form: LIST:CLEAr>

Description: **Clears all list entries by setting all pointers to 0.** Also sets LIST:DIR to UP, LIST:GEN to DSEQ, Related Commands: All LIST commands (See example, Figures B-2 and B-3.)

B.27 [SOURCE:]LIST:COUNt COMMAND

LIST:COUN

Syntax: Short Form: LIST:COUN<int_value 0 to 255> Long Form: LIST:COUNt> <int_value 0 to 255>

Description: **Establishes how many times the list is executed.** Allows user to establish how many times the list (established by LIST:GEN DSEQ or LIST:GEN SEQ and LIST:SEQ) is executed. The order (from beginning to end or from end to beginning) is determined by LIST:DIR. For LIST:COUN 0, the unit will execute the sequence indefinitely until either a VOLT:MODE FIXED, or PROG:STOP command is received. Commands: LIST:GEN, LIST:SEQ, LIST:DIR. (See example, Figures B-2 and B-3.)

B.28 [SOURCE:]LIST:COUNt? QUERY

LIST:COUN?

Syntax: Short Form: LIST:COUNt? Long Form: LIST:COUNt?
Return Value: <int_value>

Description: **Identifies how many times the list will be executed.** Returns value set by LIST:COUN command. (See example, Figure B-3.)

B.29 [SOURCE:]LIST:COUNT:SKIP COMMAND

LIST:COUN:SKIP

Syntax: Short Form: LIST:COUN:SKIP nn Long Form: LIST:COUNT:SKIP nn
 nn = <int_value 0 to 255>

Description: **Allows beginning steps of list-generated waveform to be run once, then ignored.**

When a list is to be repeated using LIST:COUNT, this command allows the user to skip the first nn steps once the full set has been executed. After the first iteration (which executes all steps), the first nn steps are skipped. The LIST:COUN:SKIP command allows the user to precondition a list-generated waveform by setting unique conditions at the beginning that are not repeated for the rest of the repetitions. LIST:CLEAR sets nn to 0. Only works in LIST:DIR UP mode; if LIST:DIR DOWN is issued, this command has no effect. Related Commands: LIST:COUN, LIST:COUN:SKIP?, LIST:SEQ, LIST:DIR, LIST:CLEAR. (See example, Figures B-2 and B-3.)

B.30 [SOURCE:]LIST:COUNT:SKIP? QUERY

LIST:COUN:SKIP?

Syntax: Short Form: LIST:COUN:SKIP? Long Form: LIST:COUNT:SKIP?
 Return Value: <int_value>

Description: **Identifies how many steps will be skipped the first time the list is executed.** Returns value set by LIST:COUN:SKIP command. (See examples, Figure B-3.)

B.31 [SOURCE:]LIST:CURRENt COMMAND

LIST:CURRE

Syntax: Short Form: LIST:CURRE <exp_value>, <exp_value>, . . . (to max of 1002 data points)
 Long Form: LIST:CURREnt <exp_value>, <exp_value>, . . . (to max of 1002 data points)
 <exp_value> = digits with decimal point and Exponent, e.g., 2.71E1 for 27.1

Description: **Adds the current value (in Amps) to list.** This command sequentially adds LIST:CURREnt values to the main channel List Data Table locations illustrated in Table B-2. Starting location is indicated by LIST:CURRE:POIN? These locations correspond to the default sequence (LIST:GEN DESQ). The maximum number of entries is 1002. Since the input buffer of the BIT 4886 has a limit of 253 characters, multiple commands are necessary to complete the full 1002 entries of the list. If LIST:VOLT has any entries, an error message: -221, "Settings conflict" is posted in the error queue. Related Commands: LIST:CURRE:POIN?. (See example, Figure B-3.)

TABLE B-2. LIST DATA TABLE

Location (DSEQ)	0	1	2	3	4	5	6	7	8	9	10	11	12	13	14	15	16	17	1001
Main Channel (commanded mode) LIST:CURREnt or LIST:VOLTage																			
LIST:DWELI																			

NOTE: FUNC:MODE determines whether main channel is for voltage or current. FUNC:MODE CURRE must precede LIST:CURRE commands, FUNC:MODE VOLT must precede LIST:VOLT commands

B.32 [SOURCE:]LIST:CURREnt? QUERY

LIST:CURRE?

Syntax: Short Form: LIST:CURRE? Long Form: LIST:CURREnt?
 Return Value: <value1>, <value2>, . . . to <value16>

Description: **Identifies the parameters (main channel) entered for the list.** Starting at location established by LIST:QUERY, returns comma-separated list of up to 16 values indicating the main channel parameters entered, i.e., the contents of main channel locations of Table B-2. Related Commands: LIST: CURRE, LIST:QUERY. If LIST:VOLT has any entries, an error message: -221, "Settings conflict" is posted in the error queue. (See example, Figure B-3.)

B.33 [SOURCE:]LIST:CURREnt:POINtS? QUERY

LIST:CURRE:POIN?

Syntax: Short Form: LIST:CURRE:POIN? Long Form: LIST:CURREnt:POINtS?
 Return Value: <value> (0 to 1001)

Description: **Identifies the total number of points in a list and the next location to be filled by LIST:CURRE command.** The LIST:CURRE pointer is initially at 0 via LIST:CLEAR. For each data point entered by a LIST:CURRE command the list pointer is incremented. If LIST:CURRE:POIN? returns 5, the LIST:CURRE pointer is at 5, indicating there are 6 data points comprising the list. If LIST:VOLT has any entries, an error message: -221, "Settings conflict" is posted in the error queue. Related Commands: LIST:CURRE. (See example, Figure B-3.)

B.34 [SOURCE:]LIST:DIRrection COMMAND

LIST:DIR

Syntax: Short Form: LIST:DIR (UP|DOWN) Long Form: LIST:DIRrection (UP|DOWN)

Description: **Allows the list to be executed from beginning to end (UP) or from end to the beginning (DOWN).** *RST or LIST:CLEar sets the list to the UP direction (beginning to end). Works with both LIST:GEN DSEQ and LIST:GEN SEQ commands. Related Commands: LIST:GEN. LIST:SEQ, LIST:DWEL?. (See example, Figures B-2 and B-3.)

B.35 [SOURCE:]LIST:DIRrection? QUERY

LIST:DIR?

Syntax: Short Form: LIST:DIR? Long Form: LIST:DIRrection?
Return Value: <value> (UP or DOWN)

Description: **Identifies the direction (up or down) for executing the list established by LIST:DIR.** Related Commands: LIST: DIR. (See example, Figure B-3.)

B.36 [SOURCE:]LIST:DWELI COMMAND

LIST:DWEL

Syntax: Short Form: LIST:DWEL <value> (0.0005 to 10),<value>,<value>, . . . to maximum of 1002 values
Long Form: LIST:DWELI <value> (0.0005 to 10),<value>,<value>, . . . to maximum of 1002 values

Description: **Determines how long the main channel parameters will be active.** Sets time value (from 0.0005 to 10) in seconds for List:Dwell locations illustrated in Table B-2. These locations are associated with the corresponding main channel locations illustrated in Table B-2. The main channel is determined by FUNC:MODE, either current (FUNC:MODE CURR) or voltage (FUNC:MODE VOLT) if LIST:DWEL is entered for only location 0, that time duration will apply to all steps when either VOLT:MODE LIST or CURR:MODE LIST is executed. Related Commands: VOLT:MODE, FUNC:MODE, LIST:CURR, LIST:VOLT, LIST:DWEL?, LIST:SEQ. (See example, Figures B-2 and B-3.)

B.37 [SOURCE:]LIST:DWELI? QUERY

LIST:DWEL?

Syntax: Short Form: LIST:DWEL? Long Form: LIST:DWELI?
Return Value: <value>

Description: **Identifies the dwell times entered for the list.** Starting at location established by LIST:QUERY, returns comma-separated list of up to 16 values indicating the dwell time parameters entered. i.e., the contents of LIST:DWEL locations of Table B-2. Related Commands: LIST: DWEL, LIST:QUERY. (See example, Figure B-3.)

B.38 [SOURCE:]LIST:DWELI:POINts? QUERY

LIST:DWEL:POIN?

Syntax: Short Form: LIST:DWEL:POIN? Long Form: LIST:DWELI:POINts?
Return Value: <value> (0 to 1001)

Description: **Identifies the number of locations for which time values have been entered and the next location to be filled by a LIST:DWEL command.** If LIST:DWEL:POIN? returns 6, dwell times have been entered for locations 0 through 5 and location 6 is the next to be filled by a LIST:DWEL command. LIST:DWEL, LIST:DWEL:POIN. (See example, Figure B-3.)

SIMPLE STAIRCASE SAWTOOTH WAVEFORM EXAMPLE

*RST Resets power supply to the default state.
CURR 1 Sets programmed current to 1A.
LIST:CLE Clears all list entries by setting all pointers to 0.
LIST:VOLT -5,-4,-3,-2, -1,0,1,2,3,4,5 Create 10 steps that increases from -5V to +5V.
LIST:DWEL 2 Set the dwell time for each step to 2 seconds.
LIST:COUN 10 Determines that the list will be repeated 10 times when executed.
OUTP ON Turns the BOP output on.
VOLT:MODE LIST Initiates execution of the list.

Upon sending VOLT:MODE LIST, the unit outputs a sawtooth waveform that increases from -5V to +5V and repeats 10 times. Each step is 1V with a dwell time of 2 seconds. There is an abrupt change from +5V to -5V each time the list transitions from the last step to the first step of the waveform. After the waveform repeats 10 times, the list stops running and the unit output will be +5V (the last step in the list). The total list running time is equal to:

$10 \text{ (from LIST COUN)} \times 11 \text{ (total number of list steps)} \times 2 \text{ seconds (dwell time of each step)} = 220 \text{ seconds}$

To invert the waveform, when the list stops running, add the following command between OUTP ON and VOLT:MODE LIST above.

LIST:DIR DOWN List direction is from the end to the beginning of the list.

Upon sending VOLT:MODE LIST, the unit outputs an inverted sawtooth waveform that is similar to the non inverted waveform, except it decreases from +5V to -5V and abruptly returns to +5V. After the waveform repeats 10 times, the list stops running and the unit output will be -5V (the first step in the list, and the last step executed). The total list running time is the same as before the direction was reversed.

SIMPLE STAIRCASE TRIANGLE WAVEFORM EXAMPLE

*RST Resets power supply to the default state
CURR 1 Sets programmed current to 1A
LIST:CLE Clears all list entries by setting all pointers to 0.
LIST:VOLT 0,1,2,3,4,5,6,7,8,9,10 Create 11 steps that increase from 0V to +10V.
LIST:VOLT 9,8,7,6,5,4,3,2,1,0 Create 10 steps that decrease from +9V to 0V. The 21-step list forms a triangle stair waveform that first increases from 0V to +10V and then decreases to 0V.
LIST:DWEL 2 Sets the dwell time for each step to 2 seconds.
LIST:COUN 10 Determines that the list will be repeated 10 times when executed.
OUTP ON Turns the BOP output on
VOLT:MODE LIST Initiates execution of the list.

The unit outputs a triangle stair waveform, that increases from 0V to +10V and then decrease to 0V. The waveform repeats 10 times. Each step is 1V with a dwell time of 2 seconds. The waveform stays at 0V for 4 seconds because for each repetition, the last step of the decreasing list and the first step of the increasing list are both 2 seconds at 0V. When the list stops running, the output will be 0V (the last step of the list). The total list running time is equal to:

$10 \text{ (from LIST COUN)} \times 21 \text{ (total number of list steps)} \times 2 \text{ seconds (dwell time of each step)} = 420 \text{ seconds}$

To eliminate the first step and make the waveform times even, when the list stops running, add the following command between OUTP ON and VOLT:MODE LIST above.

LIST:COUN:SKIP 1 Skip first step (0V level) after the first iteration

Upon sending VOLT:MODE LIST, the unit outputs a triangle stair waveform, that is identical to the original, except that the first step (0V) is only executed for the first iteration. After 10 repetitions the list stops running and the output is 0V. The total list running time is equal to:

$10 \text{ (from LIST COUN)} \times 20 \text{ (total number of repeated list steps)} \times 2 \text{ seconds (dwell time of each step)} = 400 \text{ seconds} + 2 \text{ seconds (dwell time of first step, run only once)} = 402 \text{ seconds.}$

FIGURE B-2. USING LIST COMMANDS FOR SAWTOOTH AND TRIANGLE WAVEFORMS

NOTES:	Examples below are intended only to illustrate command functions. Refer to PAR. 4.1.1 for programming techniques to optimize performance.
FUNC:MODE VOLT	Initializes the power supply mode to be voltage.
LIST:CLEAR	Initializes the list processor to add entries, clears main channel (LIST:CURR or LIST:VOLT) and LIST:DWEL data tables (Table B-2) and List Sequence table (Table B-3).
LIST:DWELL .010	Sets the time duration for location 0 to be 0.010 second (Since dwell times for the rest of the locations in this sample list are not entered before running the list, the dwell time will be 0.010 second for all locations).
LIST:VOLT -20,-18,-16,-14,-12,-10,-8,-6,-4,-2,0	Starting at location 0 (-20), up to location 10 (0), fills the list with 11 data points.
LIST:VOLT:POIN?	Returns 11. Indicates that 11 data points have been entered, and location 11 is the next location to be filled (for the 12th data point).
NOTE: See PAR. B.2 for format and accuracy of all numerical data returned.	
LIST:QUERY?	Returns 0 (pointer cleared by LIST:CLE).
LIST:VOLT?	Returns -20,-18,-16,-14,-12,-10,-8,-6,-4,-2,0 (the contents of locations 0 through 10). (See PAR. B.2 for format and accuracy of numerical data.)
LIST:VOLT 2,4,6,8,10,12,14,16,18,20	Adds 10 points to the list (location 11 through 20). List now has 21 points.
LIST:VOLT:POIN?	Returns 21 (the next location to be filled by LIST:VOLT).
LIST:VOLT?	Returns -20,-18,-16,-14,-12,-10,-8,-6,-4,-2,0,2,4,6,8 (the contents of locations 0 through 15).
LIST:GEN SEQUENCE	Enables the execution of a user-determined sequence list
LIST:SEQ 0, 0, 0, 0,1,2,3,4,5,6,7,8,9,10,11,12,13,14,15,16,17,18,19,20	Establishes the user-determined sequence.
LIST:SEQ 19,18,17,16,15,14,13,12,11,10,9,8,7,6,5,4,3,2,1,0	Continues the user-determined list sequence. The SEQ values entered mean that if LIST:GEN SEQ is issued, the list will execute location 0 four times (-20V for 40 milliseconds) location 1 through 20 and 19 through 0 (10 milliseconds each) for a total of 44 data points when VOLT:MODE LIST is issued.
LIST:SEQ?	Returns 0,0,0,0,1,2,3,4,5,6,7,8,9,10,11,12 (LIST:SEQ locations 0 through 15).
LIST:QUERY 16	Start LIST queries from location 16.
LIST:SEQ?	Returns 13,14,15,16,17,18,19,20,19,18,17,16,15,14,13,12 (LIST:SEQ locations 16 through 31).
LIST:QUERY 32	Start LIST queries from location 32.
LIST:SEQ?	Returns 11,10,9,8,7,6,5,4,3,2,1,0 (LIST:SEQ locations 32 through 43).
LIST:COUNT 100	Specifies that when VOLT:MODE LIST is issued, the user-determined sequence will be executed 100 times. (44 steps in the list will be executed 100 times)
LIST:COUN:SKIP 4	Specifies that the first 4 steps of the sequence will only be executed the first time through the list. For the subsequent 99 iterations established by LIST:COUNT 100, location 0 (-20V) will last 10 milliseconds.
CURR 1;VOLT -20	initializes the BOP output.
OUTPUT ON	Turns the output on (BOP now provides -20 volts)
VOLT:MODE LIST	Executes the list. For 40 milliseconds the BOP outputs -20V, then output a staircase triangle wave from -20V to +20V and back down to -20V. This staircase will have a uniform spacing between voltage changes of 10 milliseconds and will repeat 100 times.
VOLT?	Returns -20 (the last step in the list set the unit to -20V).
LIST:GEN?	Returns SEQ to indicate the list will be executed in the user-determined order entered by LIST:SEQ (Table B-3).

FIGURE B-3. USING LIST COMMANDS AND QUERIES (SHEET 1 OF 2)

LIST:GEN DSEQ	Changes the list to execute sequentially from locations 0 through 20).
LIST:COUN:SKIP?	Returns 4. Skip first 4 steps after the first time through count.
LIST:COUN:SKIP 0	Specifies no steps to be skipped after the first time through the count.
LIST:COUNT?	Returns 100.
LIST:COUNT 10	Determines that the list will be repeated 10 times when executed.
LIST:COUNT?	Returns 10.
VOLT:MODE LIST	Initiates execution of the list. The unit outputs a sawtooth waveform that increases from -20V to +20V and repeats 10 times. There is an abrupt change from +20V to -20V each time the list transitions from location 20 to location 0.
VOLT?	Returns 20, (the last step in the list set the unit to 20V.
LIST:VOLT:POIN?	Returns 21 (the next location to be filled by LIST:VOLT).
LIST:VOLT 10,0,-10	Add 3 points to the list (location 21 through 23).
LIST:COUN?	Returns 10 indicating that the list will be repeated 10 times when executed.
LIST:DIR?	Returns UP (the default.)
LIST:DIR DOWN	Reverses the sequence order.
VOLT:MODE LIST	The list (24 steps) is executed. The output starts at -10V, goes to 0V, to 10V to 20V then decreases to -20V in 2V steps and repeats 10 times. The sawtooth is similar to the previous sawtooth, except the waveform is inverted and the abrupt change from -20 to +20 is executed in three steps of 10 volts.
LIST:GEN?	Returns DSEQ (default sequence))
LIST:GENERATION:SEQ	Changes sequence to user determined sequence.
VOLT:MODE:LIST	The original list of 4400 points will be executed (without the three new steps.)
LIST:QUERy 0	Sets query pointer to zero.
LIST:DWEL:POIN?	Returns 1 indicating the next dwell time will be entered in location 1.
LIST:DWELL .01,.01,.01,.01,.01,.01,.01,.01,.01	Enters dwell time of 0.01 seconds in locations 1 through 9.
LIST:DWELL 1	Enters dwell time of 1 second in location 10.
VOLT:MODE LIST	the list is not executed, the unit returns error -221,Settings Error indicating the lists are not balanced.
LIST:DWELL:POINTS?	Returns 11 to indicate the dwell list has 11 entries
LIST:VOLT:POINTS?	Returns 24 to indicate the voltage list has 24 entries.
LIST:DWELL .01,.01,.01,.01,.01,.01,.01,.01,.01,.1,.1,.1	Dwell times are entered in locations 11 through 23.
DWELL:POINTS?	Returns 24 indicating there are now 24 step dwell times on the list.
LIST:QUER?	Returns 0 indicating list queries will start from location 0
LIST:QUER 18	Causes list queries to start at location 18
LIST:DWEL?	Returns .01,.01,.01,.1,.1,.1 (the dwell times for locations 18 through 23.
LIST:VOLT?	Returns 16,18,20,10,0,-10
LIST COUNT 0	List will repeat indefinitely.
VOLT:MODE LIST	The list is executed. Staircase wave now consists of 24 steps of .01 seconds except for the 0V step (location 10) which outputs 0V for 1 second. The end of the staircase has three steps of 0.1 second.
LIST:GEN?	Returns error -221,Settings Error because a LIST command cannot be executed while the LIST is still being executed.
VOLT:MODE FIX	Stops execution of the list
VOLT?	VOLT?Returns -20 (the last step in the list set the unit to -20V.
VOLT: -4	Programs output to -4V
VOLT:MODE TRAN .05	Prepares for a voltage transient lasting 0.05 seconds.
VOLT:RANG 4	Sets unit to 1/4 scale (e.g., for BOB 20-20M, maximum voltage now 5V.
VOLT: 3	Output goes to +3V for 0.05 second, then returns to -4V.

FIGURE B-3. USING LIST COMMANDS AND QUERIES (SHEET 2 OF 2)

LIST:GEN

B.39 [SOURCE:]LIST:GENERATION COMMAND

Syntax: Short Form: LIST:GEN (SEQ | DSEQ)
 Long Form: LIST:GENERATION (SEQUENCE | DSEQUENCE)

Description: **Establishes the order for executing the list.** Selects either default sequence (DSEQ) or a user-determined sequence (SEQ).

DSEQ is the default sequence shown in Table B-2 and Table B-3, 0 through 1001. When LIST:GEN DSEQ is issued, the data points are executed in order either from beginning (location 0) to end (the last location with data, up to location 1001), or from end to beginning (location 0). The order is established by LIST:DIR command.

SEQ allows the list to be executed by an arbitrary sequence (up to 512 steps) determined by LIST:SEQ and LIST:DIR. Related Commands: LIST:SEQ, LIST:DIR. (See example, Figure B-3.)

TABLE B-3. LIST SEQUENCE TABLE

LOCATION	0	1	2	3	4	5	6	7	8	9	10	11	12	13	14	15	16	17	511	512		1001
DSEQ	0	1	2	3	4	5	6	7	8	9	10	11	12	13	14	15	16	17				1001
SEQ																				NOT AVAILABLE		

LIST:GEN?

B.40 [SOURCE:]LIST:GENERATION? QUERY

Syntax: Short Form: LIST:GEN? Long Form: LIST:GENERATION?
 Return Value: <value> (SEQ or DSEQ)

Description: **Identifies the sequence for executing the list.** Returns DSEQ for the default sequence, SEQ for user-determined sequence. Related Commands: LIST:GEN. (See example, Figure B-3.)

LIST:QUER

B.41 [SOURCE:]LIST:QUERY COMMAND

Syntax: Short Form: LIST:QUER <int_value>
 Long Form: LIST:QUERY <int_value>
 int_value = 0 to 1001

Description: **Determines first location to be queried by LIST:SEQ? query.** Related Commands: LIST:SEQ?, LIST:QUER?. (See example, Figure B-3.)

LIST:QUER?

B.42 [SOURCE:]LIST:QUERY? QUERY

Syntax: Short Form: LIST:SEQ? Long Form: LIST:SEQUENCE?
 Return Value: <int_value>

Description: **Identifies first location to be queried by LIST:SEQ?, LIST:VOLT?, LIST:CURR?, LIST:DWEL? queries.** Related Commands: LIST:QUER, LIST:SEQ. (See example, Figure B-3.)

LIST:SEQ

B.43 [SOURCE:]LIST:SEQUENCE COMMAND

Syntax: Short Form: LIST:SEQ <int_value>, <int_value>, etc. to max. of 512 locations
 Long Form: LIST:SEQUENCE <int_value>, <int_value>, etc. to max. of 512 locations
 int_value = 0 to 511

Description: **Determines the order to execute data points of the list when LIST:GEN SEQ is issued. The LIST:SEQ command is provided for backward compatibility. It is not recommended to be used in any new designs as it may be eliminated at some point in the future.** Integer values fill the SEQ cells of the List Sequence Table (see Table B-3) in order, starting at location 0. For example, for a list with five points, if LIST:SEQ 4,2,1,3,0 is followed by LIST:GEN SEQ, the list will start from data point 4 (see Table B-2), then execute points 2, 1, 3, 0. (On the other hand, if LIST:GEN DSEQ is issued, data points are executed sequentially starting at 0, then 1, 2, 3, 4.) SEQ steps can be arranged to repeat steps in any order; for example a 17-step sequence for a list having five data points may be as follows: LIST SEQ 0,1,2,3,4,5,4,3,2,1,0,5,5,1,1,1 Related Commands: LIST:GEN, LIST:DIR, LIST:COUN, LIST:COUN:SKIP. (See example, Figure B-3.)

LIST:SEQ?

B.44 [SOURCE:]LIST:SEQUENCE? QUERY

Syntax: Short Form: LIST:SEQ? Long Form: LIST:SEQUENCE?
 Return Value: <value1>, <value2>, . . . to <value16>

Description: **Identifies the user-determined sequence for executing the list.** Starting at location established by LIST:QUERY, returns comma-separated list of up to 16 values indicating the user-determined sequence for executing the list, i.e., the contents of the SEQ locations of Table B-3. Related Commands: LIST:SEQ, LIST:QUERY. (See example, Figure B-3.)

B.45 [SOURCE:]LIST:VOLTage COMMAND

LIST:VOLT

Short Form: LIST:VOLT[:LEV] <exp_value>, <exp_value>, . . . (to max of 1002 data points)

Long Form: LIST:VOLTage[:LEVel] <exp_value>, <exp_value>, . . . (to max of 1002 data points)
<exp_value> = digits with decimal point and Exponent, e.g., 2.71E1 for 27.1

Description: **Adds the voltage value (in Volts) to list.** This command sequentially adds LIST:VOLTage values to the main channel List Data Table locations illustrated in Table B-2. LIST:CLE sets starting location to 0. Next location indicated by LIST:VOLT:POIN? These locations correspond to the default sequence (LIST:GEN DESQ) The maximum number of entries is 1002. Since the input buffer of the BIT 4886 has a limit of 253 characters, multiple commands are necessary to complete the full 1002 entries of the list. If LIST:CURR has any entries, an error message: -221, "Settings conflict" is posted in the error queue. Related Commands: LIST:VOLT:POIN?, FUNC:MODE, LIST:CLE, *RST. (See example, Figures B-2 and B-3.)

B.46 [SOURCE:]LIST:VOLTage? QUERY

LIST:VOLT?

Syntax: Short Form: LIST:VOLT? Long Form: LIST:VOLTage?
Return Value: <value1>, <value2>, . . . to <value16>

Description: **Identifies the parameters (main channel) entered for the list.** Starting at location established by LIST:QUERY, returns comma-separated list of up to 16 values indicating the main channel parameters entered. i.e., the contents of the main channel locations of Table B-2. Related Commands: LIST:VOLT, LIST:QUERY. If LIST:CURR has any entries, an error message: -221, "Settings conflict" is posted in the error queue. (See example, Figure B-3.)

B.47 [SOURCE:]LIST:VOLTage:POINts? QUERY

LIST:VOLT:POIN?

Syntax: Short Form: LIST:VOLT:POIN? Long Form: LIST:VOLTage:POINts?
Return Value: <value> (0 to 1001)

Description: **Identifies the total number of points in a list and the next location to be filled by LIST:VOLT command.** The LIST:VOLT pointer is initially at 0 via *RST or LIST:CLE. For each data point entered by a LIST:VOLT command the list pointer is incremented. If LIST:VOLT:POIN? returns 5, the LIST:VOLT pointer is at 5 indicating there are 5 data points comprising the list (locations 0 through 4) and location 5 is the next to be filled. If LIST:CURR has any entries, an error message: -221, "Settings conflict" is posted in the error queue. Related Commands: LIST:VOLT. (See example, Figure B-3.)

B.48 [SOURCE:]CURRent[:LEVel][:IMMEDIATE][:AMPLitude] COMMAND

CURR

Syntax: Short Form: [SOUR:]CURR[:LEV][:IMM][:AMP] <exp_value>
Long Form: [SOURCE:]CURRent[:LEVel][:IMMEDIATE][:AMPLitude] <exp_value>
<exp_value> = digits with decimal point and Exponent, e.g., 2.71E1 for 27.1

Description: **Sets programmed current level at power supply output.** This command programs output current to a specific value; actual output current will depend on load conditions. If CURR:RANG is set to 4, any data that exceeds 1/4 of I_{MAX} causes error message -222 "data out range" to be posted to the error queue (See example, Figure B-4.)

B.49 [SOURCE:]CURRent[:LEVel][:IMMEDIATE][:AMPLitude] QUERY

CURR?

Syntax: Short Form: [SOUR:]CURR[:LEV][:IMM][:AMP]? MIN, MAX
Long Form: [SOURCE:]CURRent[:LEVel][:IMMEDIATE][:AMPLitude]? MIN, MAX
Return Value: <exp_value> = digits with decimal point and Exponent, e.g., 2.71E1 for 27.1

Description: **Returns either the programmed value, maximum value, or minimum value of current.** The CURR? query returns the programmed value of current. Actual output current will depend on load conditions. The CURR?MAX query returns the maximum current allowed for a particular model. CURR?MIN returns minimum current allowed for power supply (always negative). **Related Commands:** CURR. (See example, Figure B-4.)

- NOTES: 1. The power supply is assumed to be operating in Voltage mode.
 2. Examples below are intended only to illustrate command functions. Refer to PAR. 4.1.1 for programming techniques to optimize performance.

OUTP ON	Turns the output on.
VOLT 21; CURR 1.5	Since power supply is in voltage mode, output is programmed to go to 21V, current limit 1.5A.
INIT:CONT ON	Continuous triggers enabled.
INIT:CONT?	Power supply returns "1."
VOLT:TRIG 15;CURR:TRIG 3	Power supply output programmed to return to 15V, current limit 3A upon receipt of trigger.
*TRG	Power supply output returns to 15V,current limit 3A.
VOLT 21; CURR 5E-2	Power supply output programmed to go to 21V, current limit 0.05A.
MEAS:VOLT?	If actual value of output voltage is 20.9V, power supply returns 2.09E1.
MEAS:CURR?	If actual value of output current is 0.0483A, power supply returns 4.83E-2.
FUNC:MODE CURR	Establishes Current mode as power supply operating mode.
VOLT 21; CURR 1.1	Power supply programmed to voltage limit 21V, 1.1A.
CURR?	Returns 1.1.
FUNC:MODE VOLT	Establishes Voltage mode as power supply operating mode.
CURR:TRIG?	Returns 3 (current value established by CURR:TRIG).
VOLT:TRIG?	Returns 15 (voltage value established by VOLT:TRIG).
TRIG	Power supply output returns to 15V, current limit 3A.
INIT:CONT 0	Triggers disabled.
INIT:CONT?	Power supply returns "0."
VOLT 0	Power supply output programmed to go to 0V.
MEAS:VOLT?	Returns 0. (measured output voltage).
VOLT?	Returns 0.(programmed output voltage).
CURR?	Returns 1.5 (programmed current).
MEAS:CURR?	Returns 0. (measured output current).
CURR:RANG 4	Set the current range to 1/4 of full scale. The maximum current for a 100-1 BOP is now 0.25ampere.
CURR .3	Selecting a range greater than 0.25 results in no change of output current.
CURR .2	Sets power supply to deliver 0.2 ampere at 0.024% accuracy.
CURR AUTO	The power supply remains in 1/4 scale.
CURR .5	Sets the output to be 1/2 ampere in the high range.
CURR:RANG?	Unit returns a 1 indicating unit range.is full scale.

FIGURE B-4. PROGRAMMING THE OUTPUT

B.50 [SOURce:]CURREnt:MODE COMMAND

CURR:MODE

Syntax: Short Form: [SOUR:]CURR:MODE (FIX | LIST | TRAN) nn
 Long Form: [SOURce:]CURREnt:MODE (FIXed | LIST | TRANSient) nn
 nn = <value> = time in seconds for transient

Description: **Allows the user to execute or stop a list, or to execute a transient.** The default mode is FIXed: the power supply executes commands normally, and LIST commands can be issued to establish the parameters and sequence of a list.

When CURR:MODE LIST is issued, a list is executed (See LIST commands and Figure B-3). While the list is being executed, LIST commands are not accepted and will produce a command error. Issuing CURR:MODE FIX while the list is running will stop the execution of the list and return power supply to settings in effect prior to running the list. If the list runs to completion, the settings of the last step of the list will be in effect.

CURR:MODE TRANS nn causes the next CURR: command to produce a transient pulse of nn seconds duration, after which the current reverts back to the previous setting (Similar to VOLT:MODE TRANS (see PAR. B.59 for examples). If the time nn exceeds 10 seconds, error message -222 "data out range" is posted to the error queue. **Related Commands:** LIST commands. (See example, Figures B-2 and B-3.)

B.51 [SOURce:]CURRent:MODE? QUERY**CURR:MODE?**

Syntax: Short Form: [SOUR:]CURR[:LEV]:MODE?
 Long Form: [SOURce:]CURRent[:LEVel]:MODE?
Return value: FIXED or LIST or TRANS

Description: **Identifies active current mode.** Returns LIST while list is being executed. Returns TRANSIENT after CURR:MODE:TRAN command has been issued, but before CURR: or *TRG command executes the transient. Returns FIXED while in fixed (default) mode of operation. **Related Commands:** LIST commands. (Similar to VOLT:MODE?, see Figure B-3.)

B.52 [SOURce:]CURRent[:LEVel]RANGe COMMAND**CURR:RANG**

Syntax: Short Form: [SOUR:]CURR[:LEV]:RANG <value>
 Long Form: [SOURce:]CURRent[:LEVel]:RANGe <value>
 <value> = 1 (full scale) or 4 (1/4 scale)

Description: **Allows the user to specify the operating range for control of output current.** Range = 1 allows control of output current from 0 to full scale. Range = 4 allows the full range of the 16 bit D to A converter to control 1/4 of the full scale output current. This command will generate a command warning error if the unit is not in current mode. It will be remembered until a func:mode command is processed. (See example, Figure B-4.)

B.53 [SOURce:]CURRent[:LEVel]RANGe? QUERY**CURR:RANG?**

Syntax: Short Form: [SOUR:]CURR[:LEV]:RANG?
 Long Form: [SOURce:]CURRent[:LEVel]:RANGe?

Description: **Identifies programmed current range.** Returns 1 (full scale) or 4 (1/4 scale) (See example, Figure B-4.)

CURR:RANG:AUTO**B.54 [SOURce:]CURRent[:LEVel]RANGe:AUTO COMMAND**

Syntax: Short Form: [SOUR:]CURR[:LEV]:RANG:AUTO <boolean>
 Long Form: [SOURce:]CURRent[:LEVel]:RANGe:AUTO <boolean>
 <boolean> = 1 (on) or 0 (off)

Description: **Allows the user to specify automatic range for control of output voltage or current.** Upon power up or upon receiving *RST, automatic ranging is selected. Automatic ranging can be turned off by VOLT:RANG:AUTO 0, CURR:RANG:AUTO 0, VOLT:RANG 1 or 4, or CURR:RANG 1 or 4. When automatic ranging is set, the correct range is automatically selected based on the programmed parameter. If the programmed parameter is more than 1/4 of nominal full scale, full scale is selected; if equal to or less than 1/4 of full scale, the 1/4 scale range is selected. For example, if auto ranging is set for a unit with 100V nominal output operating in voltage mode, a programmed voltage of up to 25.0V automatically selects range to 1/4 scale, while programming anything above 25.0V selects full scale. Function is identical to VOLT:RANG:AUTO.

B.55 [SOURce:]CURRent[:LEVel]TRIGgered[:AMPLitude] COMMAND**CURR:TRIG**

Syntax: Short Form: [SOUR:]CURR[:LEV]:TRIG[:AMP] <exp_value>
 Long Form: [SOURce:]CURRent[:LEVel]:TRIGgered[:AMPLitude] <exp_value>
 <exp_value> = digits with decimal point and Exponent, e.g., 2.71E1 for 27.1

Description: **Programs current value to be transferred to output by *TRG or TRIG commands.** This command can be used to reset many power supplies to preselected parameters by issuing a single *TRG or TRIG command. Actual output current will depend on load conditions. If the value exceeds the maximum for the model being programmed, error message -222, "Data out of range" is posted in output queue. **Related Commands:** CURR, *TRG, TRIG (See example, Figure B-5.)

B.56 [SOURce:]CURRent[:LEVel]TRIGgered[:AMPLitude]? QUERY**CURR:TRIG?**

Syntax: Short Form: [SOUR:]CURR[:LEV]:TRIG[:AMP]?
 Long Form: [SOURce:]CURRent[:LEVel]:TRIGgered[:AMPLitude]?
Return Value: <exp_value> = digits with decimal point and Exponent, e.g., 2.71E1 for 27.1

Description: **Returns the current value established by CURR:TRIG command.** (See example, Figure B-5.)

- NOTES: 1. The power supply is assumed to be operating in Voltage mode.
 2. Examples below are intended only to illustrate command functions. Refer to PAR. 4.1.1 for programming techniques to optimize performance.

*RST	BOP goes to 0 volts, 0 amperes, Voltage mode.
VOLT 10;CURR 1	The voltage is placed in memory of the BOP. No Output Changes.
OUTP ON	Turns on Output, 10 Volts up to 1 ampere will be delivered.
VOLT:TRIG 1;CURR:TRIG 2	Trigger is placed in RAM.
*SAV 6	Volt 1, Current 2 and Volt mode stored in Memory location 6.
*TRG	No action - Trigger control not sent.
VOLT:TRIG 3;FUNC:MODE:TRIG CURR	No action - Trigger placed in RAM.
*SAV 7	Volt 3, curr 2, current mode saved in location 7
*RCL 6;VOLT:TRIG?	BOP returns 1 (= 1V) (saved value of memory 6)
FUNC:MODE:TRIG?	BOP returns 0 (= trigger will command voltage mode)
*RCL 6;VOLT?	BOP returns 1 (output voltage now set to 1V.).
*RCL 7;;INIT;:VOLT:TRIG?	Enables the trigger capability, unit returns 3 (= 3V)
*TRG	The voltage is set to 3, and the unit mode changes to Current
FUNC:MODE:TRIG?;:FUNC MODE VOLT	Unit switches to voltage mode. Returns 1 (= trigger will command current mode.
FUNC:MODE:TRIG?	Unit returns 0 indicating Voltage mode trigger in effect.

FIGURE B-5. USING RECALL AND TRIGGER FUNCTIONS

B.57 [SOURce:]VOLTage[:LEVel][:IMMediate][:AMPlitude] COMMAND

VOLT

Syntax: Short Form: [SOUR:]VOLT[:LEV][:IMM][:AMP] <exp_value>
 Long Form: [SOURce:]VOLTage[:LEVel][:IMMediate][:AMPlitude] <exp_value>
 <exp_value> = digits with decimal point and Exponent, e.g., 2.71E1 for 27.1

Description: **Sets programmed voltage level at power supply output.** This command programs output voltage to a specific value; actual output voltage will depend on load conditions. If the value exceeds the maximum for the model being programmed, error message -222, "Data out of range" is posted in output queue. (See example, Figure B-4.)

B.58 [SOURce:]VOLTage[:LEVel][:IMMediate][:AMPlitude]? QUERY

VOLT?

Syntax: Short Form: [SOUR:]VOLT[:LEV][:IMM][:AMP]? {MIN | MAX}
 Long Form: [SOURce:]VOLTage[:LEVel][:IMMediate][:AMPlitude]? {MIN | MAX}

Description: **Identifies programmed voltage, maximum allowable voltage, or minimum voltage (always 0).** The VOLT? query returns the programmed value of voltage. Actual output voltage will depend on load conditions. The VOLT?MAX query returns the maximum voltage allowed for a particular model. VOLT?MIN returns minimum voltage allowed for power supply (always negative). **Related Commands:** VOLT. (See example, Figure B-4.)

B.59 [SOURce:]VOLTage:MODE COMMAND

VOLT:MODE

Syntax: Short Form: [SOUR:]VOLT:MODE (FIX | LIST | TRAN) nn
 Long Form: [SOURce:]VOLTage:MODE (FIXed | LIST | TRANsient) nn
 nn = <value> = time in seconds for transient

Description: **Allows the user to execute or stop a list, or to execute a transient.** The default mode is FIXed: the power supply executes commands normally, and LIST commands can be issued to establish the parameters and sequence of a list.

When VOLT:MODE LIST is issued, a list is executed (See LIST commands and Figure B-3). While the list is being executed, LIST commands are not accepted and will produce a command error. Issuing VOLT:MODE FIX while the list is running will stop the execution of the list and return power supply to settings in effect prior to running the list. If the list runs to completion, the settings of the last step of the list will be in effect.

VOLT:MODE TRANn nn causes the next VOLT: command to produce a transient pulse of nn seconds duration, after which the voltage reverts back to the previous setting. E.g., VOLT:25 sets the output to 25 volts, and VOLT:MODE TRAN .02 primes the unit for a transient of 0.02 seconds. When VOLT:10 is issued, the power supply output goes to 10V for 0.02 seconds, then reverts to 25V. Similarly, sending VOLT:TRIG 14, VOLT:MODE TRAN .05 and *TRG causes the output to go to 14V for 0.05 seconds, then revert to 25V. **Related Commands:** LIST commands. (See example, Figures B-2 and B-3.)

B.60 [SOURce:]VOLTage:MODE? QUERY

VOLT:MODE?

Syntax: Short Form: [SOUR:]VOLT[:LEV]:MODE?
Long Form: [SOURce:]VOLTage[:LEVel]:MODE?
Return value: FIXED or LIST or TRANS

Description: **Identifies active voltage mode.** Returns LIST while list is being executed. Returns TRANSIENT after VOLT:MODE TRAN nn command has been issued, but before VOLT: or *TRG command executes the transient. Returns FIXED while in fixed (default) mode of operation. **Related Commands:** LIST commands. (See example, Figure B-3.)

B.61 [SOURce:]VOLTage[:LEVel]:RANGe COMMAND

VOLT:RANG

Syntax: Short Form: [SOUR:]VOLT[:LEV]:RANG <value>
Long Form: [SOURce:]VOLTage[:LEVel]:RANGe <value>
<value> = 1 (full scale) or 4 (1/4 scale)

Description: **Allows the user to specify the operating range for the active mode (either voltage or current).** When in voltage mode this command establishes the voltage range, in current mode it establishes the current range. Range = 1 allows control of output voltage or current from 0 to full scale. Range = 4 allows the full range of the 16 bit D to A converter to control 1/4 of the full scale output voltage or current to provide greater accuracy. This command overrides VOLT:RANG:AUTO and turns auto ranging off. (Similar to CURR:RANG shown in Figure B-4.)

B.62 [SOURce:]VOLTage[:LEVel]RANGe? QUERY

VOLT:RANG?

Syntax: Short Form: [SOUR:]VOLT[:LEV]:RANG?
Long Form: [SOURce:]VOLTage[:LEVel]:RANGe?
Return value: 1 (full scale) or 4 (1/4 scale)

Description: **Identifies active range.** Returns 1 (full scale) or 4 (1/4 scale) (Similar to CURR:RANG? shown in Figure B-4.)

VOLT:RANG:AUTO

B.63 [SOURce:]VOLTage[:LEVel]RANGe:AUTO COMMAND

Syntax: Short Form: [SOUR:]VOLT[:LEV]:RANG:AUTO <boolean>
Long Form: [SOURce:]VOLTage[:LEVel]:RANGe:AUTO <boolean>
<boolean> = 1 (on) or 0 (off)

Description: **Allows the user to specify automatic range for control of output voltage or current.** Upon power up or upon receiving *RST, automatic ranging is selected. Automatic ranging can be turned off by VOLT:RANG:AUTO 0, CURR:RANG:AUTO 0, VOLT:RANG 1 or 4, or CURR:RANG 1 or 4. When automatic ranging is set, the correct range is automatically selected based on the programmed parameter. If the programmed parameter is more than 1/4 of nominal full scale, full scale is selected; if equal to or less than 1/4 of full scale, the 1/4 scale range is selected. For example, if auto ranging is set for a unit with 100V nominal output operating in voltage mode, a programmed voltage of up to 25.0V automatically selects range to 1/4 scale, while programming anything above 25.0V selects full scale. Function is identical to CURR:RANG:AUTO.

B.64 [SOURce:]VOLTage[:LEVel]:TRIGgered[:AMPLitude] COMMAND ?

VOLT:TRIG

Syntax: Short Form: [SOUR:]VOLT[:LEV]:TRIG[:AMP] <exp_value>
Long Form: [SOURce:]VOLTage[:LEVel]:TRIGgered[:AMPLitude] <exp_value>
<exp_value> = digits with decimal point and Exponent, e.g., 2.71E1 for 27.1

Description: **Programs voltage value to be transferred to output by *TRG or TRIG commands.** Actual output voltage will depend on load conditions. If the value exceeds the maximum for the model being programmed, error message -222, "Data out of range" is posted in output queue. If value exceeds VOLT:LIM:HIGH value, a value corresponding to the voltage limit will be programmed. (See example, Figure B-5.)

B.65 [SOURce:]VOLTage[:LEVel]:TRIGgered[:AMPLitude]? QUERY

VOLT:TRIG?

Syntax: Short Form: [SOUR:]VOLT[:LEV]:TRIG[:AMP]?
Long Form: [SOURce:]VOLTage[:LEVel]:TRIGgered[:AMPLitude]?
Return Value: <exp_value> = digits with decimal point and Exponent, e.g., 2.71E1 for 27.1

Description: **Returns value established by VOLT:TRIG command representing voltage value to be programmed by *TRG or TRIG command.** (See example, Figure B-5.)

B.66 STATus:OPERation:CONDition QUERY

STAT:OPER:COND?

Syntax: Short Form: STAT:OPER:COND? Long Form: STATus:OPERation:CONDition?

Return Value: <int_value> 0 to 1313 (1 + 32 + 256 + 1024).

Description: **Returns the value of the Operation Condition Register (see Table B-4).** The Operation Condition Register contains unlatched real-time information about the operating conditions of the power supply. Bit set to 1 = function enabled (active, true); bit reset to 0 = function disabled (inactive, false). (See example, Figure B-6.)

TABLE B-4. OPERATION CONDITION REGISTER, OPERATION ENABLE REGISTER, AND OPERATION EVENT REGISTER BITS

CONDITION	NU	CC	NU	CV	NU	NU	NU	NU
BIT	15-11	10	9	8	7 - 6	5	4 - 1	0
VALUE	32,768 - 2048	1024	512	256	128 - 64	32	16 - 2	1

CC - POWER SUPPLY IN CURRENT MODE
 CV - POWER SUPPLY IN VOLTAGE MODE
 NU NOT USED

B.67 STATus:OPERation:ENABle COMMAND

STAT:OPER:ENAB

Syntax: Short Form: STAT:OPER:ENAB <int_value> 0 to 1313 (1 + 32 + 256 + 1024)
 Long Form: STATus:OPERation:ENABle <int_value> 0 to 1313 (1 + 32 + 256 + 1024)

Description: **Sets Operation Enable Register.** The Operation Enable Register is a mask for enabling specific bits in the Operation Event Register which will cause the operation summary bit (bit 7) of the Status Byte register to be set. Bit set to 1 = function enabled (active, true); bit reset to 0 = function disabled (inactive, false). The operation summary bit is the logical OR of all the enabled bits in the Operation Event register. (See example, Figure B-6.)

B.68 STATus:OPERation:ENABle? QUERY

STAT:OPER:ENAB?

Syntax: Short Form: STAT:OPER:ENAB? Long Form: STATus:OPERation:ENABle?

Return Value: <int_value> 0 to 1313 (1 + 32 + 256 + 1024).

Description: **Reads Operation Enable Register (see Table B-4).** Returns value of Operation Enable Register bits. Bit set to 1 = function enabled (active, true); bit reset to 0 = function disabled (inactive, false). (See example, Figure B-6.)

B.69 STATus:OPERation[:EVENT]? QUERY

STAT:OPER?

Syntax: Short Form: STAT:OPER[:EVENT]? Long Form: STATus:OPERation[:EVENT]?

Return Value: <int_value> 0 to 1313 (1 + 32 + 256 + 1024).

Description: **Indicates changes in conditions monitored by Operational Event Register (see Table B-4).** Returns the value of the Operation Event register. The Operation Event register is a read-only register which holds (latches) all events that occur. Reading the Operation Event register clears it. (See example, Figure B-6.)

B.70 STATus:PRESet COMMAND

STAT:PRES

Syntax: Short Form: STAT:PRES Long Form: STATus:PRESet

Description: **Disables reporting of all status events.** This command sets all bits of the Operation Condition (Table B-4) and Questionable Condition Registers to 0, preventing all status events from being reported. (See example, Figure B-6.)

NOTES: 1. The power supply is assumed to be operating in Voltage mode.
 2. Examples below are intended only to illustrate command functions. Refer to PAR. 4.1.1 for programming techniques to optimize performance.

STAT:PRES	Operation Condition and Questionable Condition registers are reset.
STAT:QUES:ENAB 12228	Allows latching of CE and VE bits.
STAT:OPER:ENAB 1280	Mask enabled for CC and CV bits.
STAT:OPER:ENAB?	Returns 1280 (256 + 1024) (CC and CV bits set).
INIT:CONT ON	Continuous triggers enabled.
STAT:OPER:COND?	Power supply returns 256 to indicate that power supply is in Voltage mode.
STAT:OPER?	Returns 256, indicating that since the last reading of the Operation Event Register the power supply has entered Voltage mode.
STAT:OPER?	Returns 0 indicating no changes since previous reading of the Operation Event register.
STAT:QUES?	Returns 0 (no questionable conditions occurred since previous reading
	--- OVERCURRENT CONDITION OCCURS
SYST:ERR?	Power supply returns 0, "No error" message.
*RST::VOLT 5;CURR 1;OUTP ON	The BOP is in Voltage mode and delivering 5 Volts.
*ESR?	Bop returns a 0 - all functions are normal.
FUNC:MODE CURR	BOP is in Current mode but Limit Light is on.
*ESR?;STAT:QUES:COND?	BOP returns 8;4097 - Current error.
*ESR?;STAT:QUES?	BOP returns 0;4096 - no new errors, Current Error.
*ESR?;STAT:QUES?	BOP returns 0;0 - no new errors.
MEAS:CURR?;VOLT?	BOP returns 1.0E-4;5.00003E0 - Voltage is 5 volts.
STAT:QUES:COND?	BOP returns 4097 - error still in effect.
	Short is applied to the BOP.
*ESR?;STAT:QUES:COND?	BOP returns 0;1 - Current mode is selected.
MEAS:VOLT?;CURR?	BOP returns.1E-4;1.00003E0 - Current is 1 amperes.
FUNC:MODE VOLT;*ESR?	BOP switches mode, returns 3 - settling.
*ESR?;STAT:QUES?	BOP returns 8;8194.
	Short is removed from the BOP output.
STAT:QUES:COND?	BOP returns 2, voltage mode operation OK.

FIGURE B-6. USING STATUS COMMANDS AND QUERIES

B.71 STATus:QUESTIONable[:EVENT]? QUERY

STAT:QUES?

Syntax: Short Form: STAT:QUES[EVEN]? Long Form: STATus:QUESTIONable[EVENT]?

Return Value: <int_value> actual register value

Description: **Indicates the latched condition of the Questionable Event register.** Returns the value of the Questionable Event register (see Table B-5). The Questionable Event register is a read-only register which holds (latches) all events. Only bits 13 and 12 are latched in the Status Questionable Event register. Bits 0 and 1 of the Status Questionable Condition Register are not latched in the power supply. Reading the Questionable Event register clears it. (See example, Figure B-6.)

TABLE B-5. QUESTIONABLE EVENT REGISTER, QUESTIONABLE CONDITION REGISTER AND QUESTIONABLE CONDITION ENABLE REGISTER BITS

CONDITION	NU	CE	VE	NU	CM	VM
BIT	15-14	13	12	11 - 2	1	0
VALUE	32,768 -16,359	8192	4096	2048 - 4	2	1

CE CURRENT ERROR
 VE VOLTAGE ERROR
 CM CURRENT MODE
 VM VOLTAGE MODE
 NU NOT USED

B.72 STATus:QUEStionable:CONDition? QUERY**STAT:QUES:COND?**

Syntax: Short Form: STAT:QUES:COND? Long Form: STATus:QUEStionable:CONDition?

Return Value: <int_value> actual register value

Description: **Returns the value of the Questionable Condition Register (see Table B-5).** The Questionable Condition Register contains unlatched real-time information about questionable conditions of the power supply. Bit set to 1 = condition enabled (active, true); bit reset to 0 = condition disabled (inactive, false). Bits 1 or 0 may be both be set, indicating the power supply is settling after a voltage change. (See example, Figure B-6.)

B.73 STATus:QUEStionable:ENABle COMMAND**STAT:QUES:ENAB**

Syntax: Short Form: STAT:QUES:ENAB <int_value> Long Form: STATus:QUEStionable:ENABle <int_value>

Description: **Programs Questionable Condition Enable Register (see Table B-5).** The Questionable Condition Enable Register determines which conditions are allowed to set the Questionable Condition Register; it is a mask for enabling specific bits in the Questionable Event register that can cause the questionable summary bit (bit 3) of the Status Byte register to be set. The questionable summary bit is the logical OR of all the enabled bits in the Questionable Event register. Bit set to 1 = function enabled (active, true); bit reset to 0 = function disabled (inactive, false). (See example, Figure B-6.)

B.74 STATus:QUEStionable:ENABle? QUERY**STAT:QUES:ENAB?**

Syntax: Short Form: STAT:QUES:ENAB? Long Form: STATus:QUEStionable:ENABle?

Return Value: <int_value> actual register value

Description: **Reads Questionable Condition Enable Register (see Table B-5).** Power supply returns value of Questionable Condition Enable Register, indicating which conditions are being monitored. Bit set to 1 = function enabled (active, true); bit reset to 0 = function disabled (inactive, false). **Related Commands:** STAT:QUES?. (See example, Figure B-6.)

B.75 SYSTem:BEEP COMMAND**SYST:BEEP**

Syntax: Short Form: SYST:BEEP Long Form: SYSTem:BEEP

Description: **Causes the unit to emit a brief audible tone.**

B.76 SYSTem:COMMunication:SERial:ECHO COMMAND**SYST:COMM:SER:ECHO**

Syntax: Short Form: SYST:COMM:SER:ECHO {ON | OFF}
Long Form: SYSTem:COMMunication:SERial:ECHO {ON | OFF}

Description: **Enables (ON) or disables (OFF) echo mode (see PAR. 4.5.2.1)** Sending ON causes all subsequent characters to be echoed back. Sending OFF turns off the character echo after the next line terminator character. The *RST command has no effect on echo status. See PAR. 4.1.1.2 and Figure 4-1 for special programming considerations.

B.77 SYSTem:COMMunication:SERial:ECHO? QUERY**SYST:COMM:SER:ECHO?**

Syntax: Short Form: SYST:COMM:SER:ECHO?
Long Form: SYSTem:COMMunication:SERial:ECHO?
Return Value: {ON | OFF}

Description: **Identifies whether echo mode is active (ON) or disabled (OFF) (see PAR. 4.5.2.1).**

B.78 SYSTem:COMMunication:SERial:PACE COMMAND**SYST:COMM:SER:PACE**

Syntax: Short Form: SYST:COMM:SER:PACE {NONE | XON}
Long Form: SYSTem:COMMunication:SERial:PACE {NONE | XON}

Description: **Enables (XON) or disables (NONE) data flow control via the serial interface (see PAR. 4.5.2.2).** See PAR. 4.1.1.2 and Figure 4-1 for special programming considerations.

B.79 SYSTem:COMMunication:SERial:PACE? QUERY**SYST:COMM:SER:PACE?**

Syntax: Short Form: SYST:COMM:SER:PACE {NONE | XON}
Long Form: SYSTem:COMMunication:SERial:PACE {NONE | XON}
Return Value: {XON | NONE}

Description: **Identifies whether data flow control via the serial interface is enabled (XON) or disabled (NONE) (see PAR. 4.5.2.2).** See PAR. 4.1.1.2 and Figure 4-1 for special programming considerations.

B.80 SYSTem:ERRor? QUERY**SYST:ERR?**

Syntax: Short Form: SYST:ERR? Long Form: SYSTem:ERRor?
 Return Value: <int_value,string>

Description: **Posts error messages to the output queue.** Returns the next error number followed by its corresponding error message string from the instrument error queue. The error queue is a FIFO (first in, first out) buffer that stores errors as they occur. As it is read, each error is removed from the queue and the next error message is made available. When all errors have been read, the query returns 0,"No error". If more errors are accumulated than the queue can hold, it will overflow. The oldest errors stay in the queue but the most recent errors are discarded. The last error in the queue will be -350,"Too many errors." Error messages are defined in Table B-6.

B.81 SYSTem:ERRor:CODE? QUERY**SYST:ERR:CODE?**

Syntax: Short Form: SYST:ERR:CODE? Long Form: SYSTem:ERRor:CODE?

Description: **Returns the three character error code without the ASCII definition string.** The error codes are defined in table B-6 (See example, Figure B-8.)

B.82 SYSTem:ERRor:CODE:ALL? QUERY**SYST:ERR:CODE:ALL?**

Syntax: Short Form: SYST:ERR:CODE:ALL? Long Form: SYSTem:ERRor:CODE:ALL?
 Return Value:

Description: **Returns a comma-separated list of all error codes.** A maximum of 15 codes will be returned; if the queue is empty, the power supply returns 0.

B.83 SYSTem:PASSword:CENable COMMAND**SYST:PASS:CEN**

Syntax: Short Form: SYST:PASS:CEN <val>
 Long Form: SYSTem:PASSword:CENable <val>

Description: **Sets the password enable state if the value matches the current password.** This command allows other commands such as DIAG:SAV and CALibrate to operate.

B.84 SYSTem:PASSword:CDISable COMMAND**SYST:PASS:CDIS**

Syntax: Short Form: SYST:PASS:CDIS <val> Long Form: SYSTem:PASSword:CDISable <val>
 Description: **Clears the password enable state if the <value> matches the current password.**

B.85 SYSTem:PASSword:NEW COMMAND**SYST:PASS:NEW**

Syntax: Short Form: SYST:PASS:NEW <old password>,<new password>
 Long Form: SYSTem:PASSword:NEW <old password>,<new password>

Description: **Establishes new password.** The old (current) password is checked, then replaced by the new password. (See example, Figure B-8.)

B.86 SYSTem:PASSword:STATe? QUERY**SYST:PASS:STAT?**

Syntax: Short Form: SYST:PASS:STAT? Long Form: SYSTem:PASSword:STATe?
 Return Value: <int_value> 0 or 1

Description: **Returns a 1 if the password state is enabled or a 0 if it is disabled.**

B.87 SYSTem:REMote COMMAND**SYST:REM**

Syntax: Short Form: SYST:REM {ON | OFF} or {1 | 0}
 Long Form: SYSTem:REMote {ON | OFF} or {1 | 0}

Description: **Used during serial (RS 232) communication to set the unit to remote (1 or ON) or local (0 or OFF) mode.** This command must be issued prior to commands that affect the power supply output (e.g., VOLT 10;:OUTP ON) to ensure the unit is in remote mode. See PAR. 4.5.3 and Figure B-7.

B.88 SYSTem:REMote? QUERY**SYST:REM?**

Syntax: Short Form: SYST:REM? Long Form: SYSTem:REMote?
 Return Value: {1 | 0}

Description: **Identifies whether unit is in remote mode (1) or local mode (0) during serial (RS 232) communication.** See PAR. 4.5.3 and Figure B-7.

B.89 SYSTem:SECurity:IMMediate COMMAND

SYST:SEC:IMM

Syntax: Short Form: SYST:SEC:IMM

Long Form: SYSTem:SECurity:IMMediate

Description: **Initializes all NVRAM variables to factory defaults.** Empties all memory locations.

*IDN?	Unit responds with KEPCO,BOP 20-20,E1234,1.66 (typical).
OUTP?	Unit responds with 0 indicating output is off
SYST:REM?	Unit responds with 0 indicating unit is in local mode.
SYST:REM 1	PUTS UNIT IN REMOTE MODE.
OUTP ON	Enables output
OUTP?	Unit responds with 1 (output on).
SYST:REM 0	Unit set to local mode.

FIGURE B-7. SETTING THE UNIT TO REMOTE MODE VIA SERIAL (RS 232) PORT

TABLE B-6. ERROR MESSAGES

ERROR MESSAGE	ESR ERROR BIT SET (SEE PAR. A.5)	EXPLANATION
0,"No error"	None	No error
-100,"Command error"	Command Error bit 5	Command and data understood, but more information included which is not recognized.
-120,"Numeric data error"	Command Error bit 5	Expected number but other characters were detected.
-203,"Command Protected"	Execution error bit 4	Password must be CENabled.
-221,"Settings Conflict"	Execution error bit 4	Calibration state not enabled but CALibrate command received.
-222,"Current, Voltage or Data out of range"	Execution error bit 4	Value (current or voltage) exceeds power supply rating or (data) exceeds acceptable command parameters.
-223,"Too Much Data"	Execution error bit 4	During a LIST command, the list became full, preventing all the data from being added to the list.
-226,"Lists not same length"	Execution error bit 4	During a LIST command, number of DWEL list entries was not equal to 1 and did not match number of LIST:VOLT or LIST:CURR entries.
-240,"Hardware error"	Execution error bit 4	Power supply did not respond to command.
-301,"Voltage Error"	Device Error bit 3 ⁽¹⁾	Voltage output not within error window; unit set to output off -- only valid for DIAG:ERR 1, 2 or 3 mode (see PAR. 4.7.1 and Table 4-5).
-302,"Current Error"	Device Error bit 3 ⁽¹⁾	Current output not within error window; unit set to output off -- only valid for DIAG:ERR 1, 2 or 3 mode (see PAR. 4.7.1 and Table 4-6).
-311,"Memory Error"	Device Error bit 3 ⁽¹⁾	*SAV (save), *RCL (recall), or CALibrate:STORe error.
-350,"Queue Overflow"	Device Error bit 3 ⁽¹⁾	Error queue was full, error events have been lost.
-400,"QueryError"	Query Error bit 2	Data requested was lost due to 253 character limit of BIT 4886 output buffer.
-420,"Query Unterminated"	Query Error bit 2	Controller sent query but did not accept data from power supply. See VOLT? (PAR. B.58), CAL:SAVE (PAR. B.58) commands
(1)	The Device error bit may be set when the status monitoring functions of the power supply detect an overvoltage/undervoltage condition.	

B.90 SYSTem:SET COMMAND

SYST:SET

Syntax: Short Form: SYSTem:SET {CM0 | CM1 | DC0 | DC1 | LF0 | LF1 | RO0 | RO1}
Long Form: SYSTem:SET {CM0 | CM1 | DC0 | DC1 | LF0 | LF1 | RO0 | RO1}

Description: **Establishes Device Clear, Line Feed, and Reset functions. Sending SYST:SEC:IMM sets LF1, DC0, and RO0 (as if CM0 was sent)**

DC0	Device Clear functions per IEEE 488.2 Standard: No effect on the device (power supply), only clears internal status registers.
DC1	Device Clear functions identical to *RST: Output set to 0V, voltage mode and output set to OFF except if RO1 (see below) is set.
LF0	Line Feed not provided upon empty buffer condition.
LF1	Line Feed provided if buffer is empty and a read is performed.
RO0	*RST and power up set output to OFF, 0V, 0A, voltage mode.
RO1	*RST sets output to ON, 0V, 0A, voltage mode. Subsequent VOLT and CURR commands are immediately present at the output without sending OUTP ON (OUTP OFF and OUTP ON function normally to turn the output off or on).
CM0	Establishes DC0, LF0, RO0 conditions described above (SCPI 1997 Standard compliance).
CM1	Establishes DC1, LF1, RO1 conditions described above. (Compatible with software versions 1.2 and earlier.) (See example, Figure B-8.)

B.91 SYSTem:SET? QUERY

SYST:SET?

Syntax: Short Form: SYST:SET? Long Form: SYSTem:SET?
Return Value: DC<n>,LF<n>,RO<n> where n = 0 or 1

Description: **Identifies functions established by SYST:SET command.** (See example, Figure B-8.)

B.92 SYSTem:VERSion? QUERY

SYST:VERS?

Syntax: Short Form: SYST:VERS? Long Form: SYSTem:VERSion?
Return Value: <int_value>.<int_value> (YYYY.V)

Description: **Identifies SCPI Version implemented.** Returns SCPI Version number:
YYYY = year, V = Revision number for specified year. (See example, Figure B-8.)

SYST:VERS?	Unit returns 1997
SYST:SET?	Unit returns DC0,LF0,RL0
SYST:PASS:NEW DEFAULT,OKAY	Unit changes password to be OKAY
SYST:SET LF1,RL1,DC1	Configures BIT 4886 card as BIT 4882 (see PAR. 1.3.1).
DIAG:SAV;:SYST:ERR:CODE?	BOP returns -231 indicating command is protected
SYST:PASS:CEN OKAY	Password enabled commands are accepted
DIAG:SAV	Unit saves the LF1 state for next power on cycle.

FIGURE B-8. USING SYSTEM COMMANDS AND QUERIES

