

# OPERATOR'S MANUAL

## KLN 750W, 1500W, 3000W PROGRAMMABLE D-C POWER SUPPLY LOW PROFILE

KEPCO INC.  
An ISO 9001 Company.

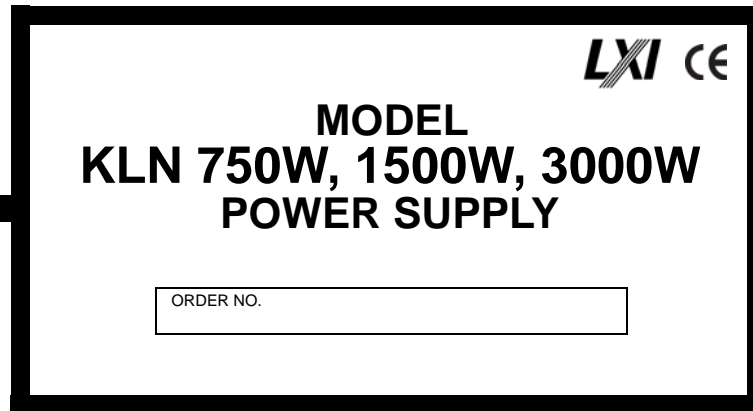

### IMPORTANT NOTES:

- 1) This manual is valid for the following Firmware Versions:  
FIRMWARE VERSION NOTE.  
Main Control 1.70 and higher
- 2) A Change Page may be included at the end of the manual. All applicable changes and revision number changes are documented with reference to the equipment serial numbers. Before using this Instruction Manual, check your equipment firmware version number to identify your model. If in doubt, contact your nearest Kepco Representative, or the Kepco Documentation Office in New York, (718) 461-7000, requesting the correct revision for your particular model and firmware version number.
- 3) The contents of this manual are protected by copyright. Reproduction of any part can be made only with the specific written permission of Kepco, Inc.

Data subject to change without notice.

©2017, KEPCO, INC  
P/N 243-1339-r14





# OPERATOR SAFETY INSTRUCTIONS

Read these safety instructions, as well as the applicable installation and operating instructions contained in this manual before using the power supply.



Do not touch the output terminals. The output is dangerous. Electric shock can cause injury or death.

Do not remove the cover or disassemble the unit. There are no operator serviceable components or adjustments inside the unit. High voltage components inside the unit can cause serious injury even with input power disconnected.

Service must be referred to authorized personnel. Using the power supply in a manner not specified by Kepco, Inc. may impair the protection provided by the power supply. Observe all safety precautions noted throughout this manual. Table 1-6 lists symbols used on the power supply or in this manual where applicable.



# TABLE OF CONTENTS

SECTION	PAGE
<b>SECTION 1 - INTRODUCTION</b>	
1.1	Scope of Manual ..... 1-1
1.2	General Description..... 1-1
1.3	Specifications ..... 1-2
1.4	Local Control ..... 1-12
1.5	Remote Control ..... 1-12
1.6	Analog Control..... 1-12
1.7	Features ..... 1-12
1.7.1	Digital Calibration..... 1-12
1.7.2	Protection..... 1-12
1.7.3	Saving and Recalling Settings ..... 1-12
1.7.4	Parallel and Series Configurations ..... 1-12
1.7.5	Miscellaneous Features..... 1-13
1.8	Equipment Supplied ..... 1-13
1.9	Accessories ..... 1-14
1.10	Safety ..... 1-15
<b>SECTION 2 - INSTALLATION</b>	
2.1	Unpacking and Inspection ..... 2-1
2.2	Terminations and Controls ..... 2-1
2.3	Preliminary Operational Check..... 2-4
2.4	Installation ..... 2-6
2.4.1	Rack Mounting 750W Models..... 2-6
2.4.1.1	Mounting One 750W 1/2-rack Unit in 19-inch Rack..... 2-6
2.4.1.2	Mounting Two 750W 1/2-rack Units in 19-inch Rack..... 2-7
2.4.2	Rack Mounting 1500W Models..... 2-8
2.4.3	Rack Mounting 3000W Models..... 2-8
2.5	Wiring Instructions..... 2-8
2.5.1	Safety Grounding..... 2-8
2.5.2	Source Power Connections ..... 2-9
2.5.3	D-C Output Grounding..... 2-9
2.5.4	Power Supply/Load Interface..... 2-10
2.5.5	Load Connection - General..... 2-10
2.5.6	Load Connection Using Local Sensing..... 2-12
2.5.7	Load Connection Using Remote Sensing..... 2-13
2.6	Cooling ..... 2-14
2.7	Setting up the unit ..... 2-14
2.7.1	Setup for Local Operation..... 2-14
2.7.2	Setup for Remote Operation via RS-485..... 2-14
2.7.3	Setup for Remote Operation via USB)..... 2-15
2.7.4	Setup for Remote Operation via GPIB (IEEE 488) ..... 2-15
2.7.5	Setup for Remote Operation via LAN ..... 2-16
2.8	Multiple Unit Configurations ..... 2-17
2.8.1	Series Connections..... 2-17
2.8.2	Parallel Connections..... 2-19
<b>SECTION 3 - OPERATION</b>	
3.1	General..... 3-1
3.2	Power Supply Basics..... 3-2
3.2.1	Turning the Power Supply On..... 3-4
3.2.2	Menu Structure ..... 3-6
3.3	Local Mode Operation ..... 3-6
3.3.1	Setting Local/Remote Mode ..... 3-6
3.3.1.1	Front Panel Lockout..... 3-8
3.3.2	Set Voltage or Overvoltage Protection (OVP) ..... 3-8
3.3.3	Set Current or Overcurrent Protection (OCP)..... 3-8

# TABLE OF CONTENTS

SECTION		PAGE
3.3.4	OVP/OVC Operation and Recovery.....	3-9
3.3.5	Enabling/Disabling DC Output Power .....	3-9
3.3.6	Storing Power Supply Output Settings.....	3-9
3.3.7	Recalling Power Supply Output Settings .....	3-10
3.3.8	Output Mode (Voltage Set: Direct or Enter) .....	3-10
3.3.9	Power On Setting.....	3-11
3.3.10	Rise Time (Ramp up).....	3-11
3.3.11	Fall Time (Ramp Down).....	3-11
3.3.12	Memory Flag.....	3-12
3.3.13	Beep.....	3-12
3.3.14	Display Brightness .....	3-12
3.3.15	I/O Select .....	3-13
3.3.16	RS-485 Baud Rate.....	3-13
3.3.17	GPIO Address (GPIO Interface Only).....	3-13
3.3.18	RS-485 Address.....	3-14
3.3.19	DHCP Function On/Off Control (LAN Interface Only) .....	3-14
3.3.20	DNS Function On/Off Control (LAN Interface Only).....	3-16
3.3.21	Set/View 1st Part of IP Address (LAN Interface Only) .....	3-16
3.3.22	Set/View 2nd Part of IP Address (LAN Interface Only).....	3-17
3.3.23	Set/View 3rd Part of IP Address (LAN Interface Only).....	3-17
3.3.24	Set/View 4th Part of IP Address (LAN Interface Only).....	3-18
3.3.25	Set/View 1st Part of Subnet Mask Address (LAN Interface Only) .....	3-18
3.3.26	Set/View 2nd Part of Subnet Mask Address (LAN Interface Only) .....	3-19
3.3.27	Set/View 3rd Part of Subnet Mask Address (LAN Interface Only) .....	3-19
3.3.28	Set/View 4th Part of Subnet Mask Address (LAN Interface Only) .....	3-19
3.3.29	Set/View 1st Part of Gateway Address (LAN Interface Only) .....	3-20
3.3.30	Set/View 2nd Part of Gateway Address (LAN Interface Only) .....	3-20
3.3.31	Set/View 3rd Part of Gateway Address (LAN Interface Only).....	3-20
3.3.32	Set/View 4th Part of Gateway Address (LAN Interface Only) .....	3-21
3.3.33	Set/View 1st Part of DNS Address (LAN Interface Only).....	3-21
3.3.34	Set/View 2nd Part of DNS Address (LAN Interface Only).....	3-21
3.3.35	Set/View 3rd Part of DNS Address (LAN Interface Only) .....	3-22
3.3.36	Set/View 4th Part of DNS Address (LAN Interface Only).....	3-22
3.3.37	Parallel/Serial Master/Slave Setup .....	3-22
3.3.38	External Control of Output On/Off.....	3-23
3.3.39	Enable Voltage Control via Programming Control Port.....	3-23
3.3.40	Enable Current Control via Programming Control Port.....	3-23
3.3.41	Calibration Access .....	3-24
3.3.42	View Serial Number .....	3-24
3.3.43	View Main Control Version.....	3-24
3.3.44	View Hardware Version .....	3-24
3.3.45	View 1st Part of MAC Address (LAN Interface Only).....	3-24
3.3.46	View 2nd Part of MAC Address (LAN Interface Only).....	3-25
3.3.47	View 3rd Part of MAC Address (LAN Interface Only) .....	3-25
3.3.48	Reset.....	3-25
3.3.49	IP Address Reset (RST1) .....	3-26
3.3.50	Viewing Error Codes .....	3-26
3.4	Series/Parallel Operation.....	3-26
3.4.1	Series Operation .....	3-26
3.4.2	Discontinuing Series Operation .....	3-27
3.4.3	Parallel Operation .....	3-28
3.4.4	Discontinuing Parallel Operation.....	3-29
3.5	Analog Remote Mode Programming .....	3-29
3.5.1	Remote Output On/off .....	3-29
3.5.2	Remote Emergency Shutdown .....	3-29

# TABLE OF CONTENTS

SECTION	PAGE
3.5.3	Remote Control of Output Voltage Using an analog signal ..... 3-30
3.5.4	Remote Control of Output Current Using an analog signal ..... 3-30
3.5.5	Recalling Previously Stored Setting Using Programming Control Port..... 3-30
3.5.6	Monitoring Output Status Using Programming Control Port..... 3-30
3.5.6.1	Monitor Output Voltage or Current..... 3-30
3.5.6.2	Monitor Unit Status ..... 3-31
3.6	Digital Remote Mode Programming ..... 3-31
3.6.1	RS-485 Operation..... 3-31
3.6.2	GPIB Operation (If Option Installed)..... 3-31
3.6.2.1	IEEE 488 (GPIB) Bus Protocol ..... 3-32
3.6.3	LAN Operation (If Option Installed)..... 3-34
3.6.3.1	Network Status..... 3-35
3.6.3.2	Viewing and/or Changing IP Configuration ..... 3-35
3.6.3.3	Changing LAN Password..... 3-37
3.6.3.4	Instrument Control ..... 3-37
3.6.3.5	Operation Via HyperTerminal. .... 3-38
3.7	SCPI Programming ..... 3-39
3.7.1	SCPI Messages ..... 3-40
3.7.2	Common Commands/Queries ..... 3-40
3.7.3	SCPI Subsystem Command/query Structure ..... 3-40
3.7.3.1	Calibrate Subsystem..... 3-40
3.7.3.2	Display Subsystem ..... 3-40
3.7.3.3	Fetch Subsystem ..... 3-40
3.7.3.4	Output Subsystem ..... 3-40
3.7.3.5	Source Subsystem..... 3-40
3.7.3.6	System Subsystem ..... 3-40
3.7.4	Understanding The Command Structure ..... 3-41

## SECTION 4 - CALIBRATION

4.1	General..... 4-1
4.2	Equipment Required..... 4-1
4.3	Voltage Calibration Procedure ..... 4-1
4.4	Current Calibration Procedure..... 4-3

## APPENDIX A - SCPI COMMON COMMAND/QUERY DEFINITIONS

A.2	*CLS — Clear Status Command..... A-1
A.3	*IDN? — Identification Query ..... A-1
A.4	*RST — Reset Command ..... A-1
A.5	*TST? — Self Test Query..... A-1

## APPENDIX B - SCPI COMMAND/QUERY DEFINITIONS

B.1	Introduction..... B-1
B.2	Numerical Values ..... B-1
B.3	DISP:CONTRast Command..... B-1
B.4	DISP:CONTRast? Query ..... B-2
B.5	FETCh? Query ..... B-2
B.6	MEASure:ADDRes? Query ..... B-2
B.7	MEASure:CURRent? Query..... B-2
B.8	MEASure:VOLTagE? Query..... B-2

# TABLE OF CONTENTS

SECTION		PAGE
B.9	OUTPut Command.....	B-3
B.10	OUTPut? Query .....	B-3
B.11	OUTPut:PON Command .....	B-3
B.12	OUTPut:PON? Query .....	B-3
B.13	OUTPut:PROtection:CLEar Command .....	B-3
B.14	SOURce:CURRent Command.....	B-4
B.15	SOURce:CURRent? Query .....	B-4
B.16	SOURce:CURRent:PROtection:LEVel Command .....	B-4
B.17	SOURce:CURRent:PROtection:LEVel? Query .....	B-4
B.18	SOURce:CURRent:PROtection:STATe Command .....	B-4
B.19	SOURce:CURRent:PROtection:STATe? Query.....	B-4
B.20	SOURce:CURRent:PROtection:TRIPped? Query.....	B-5
B.21	SOURce:LIST:DTIME Command .....	B-5
B.22	SOURce:LIST:DTIME? Query.....	B-5
B.23	SOURce:LIST:RTIME Command.....	B-5
B.24	SOURce:LIST:RTIME? Query.....	B-5
B.25	SOURce:MEMory:CLS Command.....	B-5
B.26	SOURce:MEMory:CURRent:X Command .....	B-5
B.27	SOURce:MEMory:CURRent:X? Query.....	B-6
B.28	SOURce:MEMory:LIST:X? Query .....	B-6
B.29	SOURce:MEMory:RECall:X Command .....	B-6
B.30	SOURce:MEMory:VOLTag:e:X Command .....	B-6
B.31	SOURce:MEMory:VOLTag:e:X? Query .....	B-6
B.32	SOURce:VOLTag:e Command .....	B-6
B.33	SOURce:VOLTag:e? Query .....	B-7
B.34	SOURce:VOLTag:e:LIMit:LOW Command.....	B-7
B.35	SOURce:VOLTag:e:LIMit:LOW? Query .....	B-7
B.36	SOURce:VOLTag:e:PROtection:LEVel Command.....	B-7
B.37	SOURce:VOLTag:e:PROtection:LEVel? Query .....	B-7
B.38	SOURce:VOLTag:e:PROtection:TRIPped? Query .....	B-8
B.39	SYSTem:BEEP Command .....	B-8
B.40	SYSTem:BEEP? Query.....	B-8
B.41	SYSTem:COMMunicate:LAN:DHCP Command .....	B-8
B.42	SYSTem:COMMunicate:LAN:DHCP? Query.....	B-8
B.43	SYSTem:COMMunicate:LAN:DNS Command.....	B-8
B.44	SYSTem:COMMunicate:LAN:DNS? Query .....	B-9
B.45	SYSTem:COMMunicate:LAN:DNS:AUTO Command.....	B-9
B.46	SYSTem:COMMunicate:LAN:DNS:AUTO? Query .....	B-9
B.47	SYSTem:COMMunicate:LAN:GATEway Command .....	B-9
B.48	SYSTem:COMMunicate:LAN:GATEway? Query .....	B-9
B.49	SYSTem:COMMunicate:LAN:IP Command.....	B-9
B.50	SYSTem:COMMunicate:LAN:IP? Query .....	B-10
B.51	SYSTem:COMMunicate:LAN:IPAdDress Command .....	B-10
B.52	SYSTem:COMMunicate:LAN:IPAdDress? Query.....	B-10
B.53	SYSTem:COMMunicate:LAN:MAC? Query.....	B-10
B.54	SYSTem:COMMunicate:LAN:RESet Command .....	B-10
B.55	SYSTem:COMMunicate:LAN:SMAS Command .....	B-10
B.56	SYSTem:COMMunicate:LAN:SMAS? Query.....	B-11
B.57	SYSTem:COMMunicate:LAN:TELnet:PORT Command .....	B-11
B.58	SYSTem:COMMunicate:LAN:TELnet:PORT? Query.....	B-11
B.59	SYSTem:ERRor? Query .....	B-11
B.60	SYSTem:KLOCK Command.....	B-12
B.61	SYSTem:KLOCK? Query .....	B-12
B.62	SYSTem:LOCal Command .....	B-13
B.63	SYSTem:REMote Command .....	B-13
B.64	SYSTem:VERSion? Query .....	B-13



# LIST OF FIGURES

FIGURE	TITLE	PAGE
1-1	KLN Power Supply, Automatic Crossover Characteristics .....	1-1
1-2	KLN 750W Power Supply, Outline Drawing .....	1-7
1-2	KLN 750W Power Supply, Outline Drawing (two units Mounted in Rack) .....	1-8
1-3	KLN 1500W Power Supply, Outline Drawing sd .....	1-10
1-4	KLN 3000W Power Supply, Outline Drawing .....	1-11
2-1	KLN 750W Series Rear Panel .....	2-1
2-2	KLN 1500W Series Rear Panel .....	2-1
2-3	KLN 3000W Series Rear Panel .....	2-1
2-4	LAN Ethernet Connector (LAN Interface only) .....	2-2
2-5	RS-485 Port .....	2-2
2-6	Programming Control Port .....	2-4
2-7	Mounting One KLN 750W Unit in 19-inch Rack .....	2-6
2-8	Mounting One KLN 750W Unit in 19-inch Rack .....	2-7
2-9	Load Connection Terminals for 750W Models .....	2-10
2-10	Load Connection Terminals for 1500W Models .....	2-11
2-11	Load Connection Terminals for 3000W Models .....	2-11
2-12	Load Connections, Local Sensing .....	2-12
2-13	Load Wire Voltage Drop, Equivalent Schematic Diagram .....	2-13
2-14	Load Connections, Remote Sensing .....	2-13
2-15	RS-485 Connections .....	2-15
2-16	USB Connections .....	2-15
2-17	GPIB Connections .....	2-16
2-18	LAN Connections .....	2-16
2-19	Series Connections .....	2-17
2-20	Optional Series Connector Board .....	2-18
2-21	Programming Control Port Connections for Series Operation .....	2-18
2-22	Parallel Connections .....	2-19
2-23	Optional Parallel Connector Board .....	2-20
2-24	Programming Control Port Connections for Parallel Operation .....	2-20
3-1	KLN 750W Series Front Panel .....	3-2
3-2	KLN 1500W Series Front Panel .....	3-2
3-3	KLN 3000W Series Front Panel .....	3-2
3-4	7-Segment Display Characters .....	3-4
3-5	View/Set Address Commands used with DHCP and DNS Functions .....	3-15
3-6	Remote Control Using Programming Control Port and Optocoupler or Relay .....	3-29
3-7	Programming Control Port Status Monitoring .....	3-31
3-8	KLN Instrument Welcome Page .....	3-34
3-9	Network Status Page .....	3-35
3-10	Log In Screen .....	3-35
3-11	Network Configuration Page .....	3-36
3-12	Change Password Screen .....	3-37
3-13	Instrument Control Page .....	3-37
3-14	Open HyperTerminal Connection .....	3-38
3-15	Hyper terminal Properties .....	3-38
3-16	Hyper terminal ASCII Setup .....	3-39
3-17	Tree Diagram of SCPI Commands Used with KLN Power Supply .....	3-41
4-1	Calibration Setup .....	4-2

## LIST OF TABLES

TABLE	TITLE	PAGE
1-1	KLN Series Model Parameters .....	1-2
1-2	KLN General Specifications .....	1-3
1-3	Equipment Supplied .....	1-13
1-4	Accessories .....	1-14
1-5	Safety Symbols .....	1-15
2-1	Rear Panel Connector Functions .....	2-2
2-2	RS-485 Port Input/Output Pin Assignments .....	2-2
2-3	GPIB (IEEE 488) Port Input/Output Pin Assignments .....	2-3
2-4	Programming Control Port I/O Pin Assignments .....	2-3
2-5	Maximum Load Wire Length for Voltage drop less than 1V .....	2-13
3-1	Front Panel Controls and Indicators .....	3-3
3-2	Factory Defaults .....	3-5
3-3	Menu Functions .....	3-7
3-4	IEEE 488 (GPIB) Bus Interface Functions .....	3-32
3-5	IEEE 488 (GPIB) Bus Command Mode Messages .....	3-33
3-6	IEEE 488 (GPIB) Bus Data Mode Messages .....	3-33
3-7	VISA Resource String Corresponding to Interface .....	3-39
A-1	IEEE 488.2 Command/query Index .....	A-1
B-1	SCPI Subsystem Command/query Index .....	B-1
B-2	Error Codes .....	B-11

## SECTION 1 - INTRODUCTION

### 1.1 SCOPE OF MANUAL

This manual contains instructions for the installation and operation of the KLN series of 750, 1500W, and 3000W Watt programmable, voltage and current stabilized d-c power supplies, hereafter referred to as KLN, from Kepco, Inc., Flushing, New York, U.S.A.

### 1.2 GENERAL DESCRIPTION

KLN Series power supplies are voltage and current stabilized d-c sources with a sharp crossover between the constant voltage and constant current mode of operation. Thirty-nine models are offered, 13 in each power grouping, with rated d-c output voltage ranging from 6V to 600V and rated d-c output current ranging from 1.25A to 400A (see Table 1-1).

KLN switching power supplies operate from wide range 100-240V a-c (190-240V a-c for 3000W), 50/60 Hz input source power and employ active power factor correction (PFC). Since there are no internal adjustments, KLN Power Supplies offer excellent output voltage/current stability and easy calibration.

Output voltage and current are displayed on independent LED displays. Control of the KLN can be either local, via the front panel controls and displays, or remote, using 1) either analog signals (applied to the Programming Control Port), or 2) digital programming. Digital programming of standard models is via RS-485 communication bus. Optional IEEE 488.2 (GPIB) and LAN interfaces are also available.

KLN output and readback are high resolution: 16 bits D/A to set output voltage and current, 24 bits A/D for readback of output voltage and current. These units feature a low temperature coefficient: Constant Voltage mode: 100ppm/°C, Constant Current mode: 100ppm/°C, and built-in remote sensing with a maximum compensation of 5V voltage drop across power lines.

The KLN series is suitable for ATE automatic test, burn-in test and other applications that require lots of testing power.

The KLN power supply acts as a constant voltage source for comparatively large values of load resistance, and as a constant current source for comparatively small values of load resistance. The transition between these two modes of operation occurs automatically at a "critical" or "crossover" value of load resistance  $R_c = E_s/I_s$ , where  $E_s$  is the voltage control setting and  $I_s$  is the current control setting (see Figure 1-1).

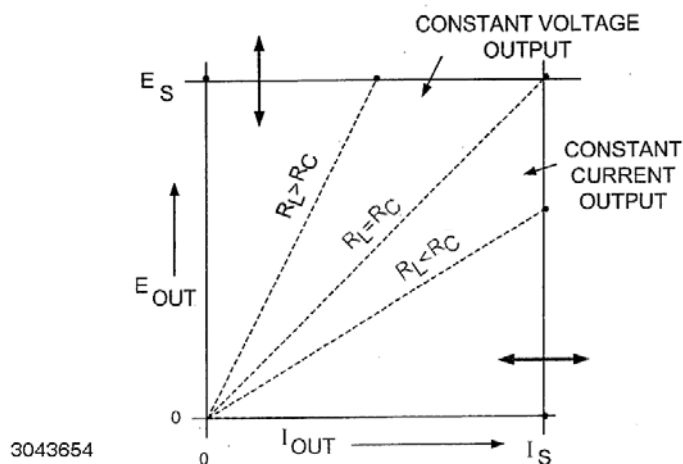

FIGURE 1-1. KLN POWER SUPPLY, AUTOMATIC CROSSOVER CHARACTERISTICS

### 1.3 SPECIFICATIONS

Table 1-1 below indicates parameters that vary for different KLN models; Table 1-2 lists general specifications that apply to all KLN models.

**TABLE 1-1. KLN SERIES MODEL PARAMETERS**

Model (8)(9)(11)(12)	d-c Output Range		Ripple <sup>(3)</sup>		Line Regulation <sup>(5)(10)</sup>		Load Regulation <sup>(10)</sup>		Response Time <sup>(7)</sup>			Remote Sense Voltage drop (max.) V
	Constant Voltage (CV) <sup>(1)</sup>	Constant Current (CC) <sup>(2)</sup>	CV	CC <sup>(4)</sup>	CV	CC	CV <sup>(6)</sup>	CC <sup>(6)</sup>	Full Load Up	Full Load Down	No Load Down	
	V d-c	A d-c	mV rms	mA rms	0.05% +mV	0.1% +mA	0.05% +mV	0.1% +mA	Sec	Sec	Sec	
<b>750W 1U Half Rack Models</b>												
KLN 6-100	0 to 6	0 to 100	10	180	2.8	11	2.8	23	0.08	0.05	0.6	1
KLN 8-90	0 to 8	0 to 90	10	180	2.8	11	2.8	23	0.08	0.05	0.6	1
KLN 12.5-60	0 to 12.5	0 to 60	10	120	4	8.5	4	18	0.08	0.05	0.8	1
KLN 20-38	0 to 20	0 to 38	10	76	4	5.8	4	12.6	0.08	0.05	0.8	1
KLN 30-25	0 to 30	0 to 25	10	63	5	4.5	5	10	0.08	0.08	0.9	1.5
KLN 40-19	0 to 40	0 to 19	10	48	6	3.9	6	8.8	0.08	0.08	1	2
KLN 50-15	0 to 50	0 to 15	10	43	8	3.6	8	8.2	0.08	0.08	1.1	2
KLN 60-12.5	0 to 60	0 to 12.5	10	38	8	3.25	8	7.5	0.08	0.08	1.1	3
KLN 80-9.5	0 to 80	0 to 9.5	10	29	10	2.95	10	6.9	0.15	0.15	1.2	4
KLN 100-7.5	0 to 100	0 to 7.5	10	23	12	2.75	12	6.5	0.15	0.15	1.5	5
KLN 150-5	0 to 150	0 to 5	16	18	17	2.5	17	6	0.15	0.15	2	5
KLN 300-2.5	0 to 300	0 to 2.5	25	13	32	2.25	32	5.5	0.15	0.15	3	5
KLN 600-1.25	0 to 600	0 to 1.25	75	8	62	2.13	62	5.26	0.25	0.3	4	5
<b>1500W 1U Full Rack Models</b>												
KLN 6-200	0 to 6	0 to 200	15	360	2.8	18.5	2.8	38	0.08	0.05	0.6	1
KLN 8-180	0 to 8	0 to 180	15	360	2.8	18.5	2.8	38	0.08	0.05	0.6	1
KLN 12.5-120	0 to 12.5	0 to 120	15	248	3.4	14.5	4	28	0.08	0.05	0.8	1
KLN 20-76	0 to 20	0 to 76	15	152	4	9.6	4	20.2	0.08	0.05	0.8	1
KLN 30-50	0 to 30	0 to 50	15	125	5	7	5	15	0.08	0.08	0.9	1.5
KLN 40-38	0 to 40	0 to 38	15	95	6	5.8	6	12.6	0.08	0.08	1	2
KLN 50-30	0 to 50	0 to 30	15	85	7	5.2	7	11.4	0.08	0.08	1.1	2
KLN 60-25	0 to 60	0 to 25	15	75	8	4.5	8	10	0.08	0.08	1.1	3
KLN 80-19	0 to 80	0 to 19	15	57	10	3.9	10	8.8	0.15	0.15	1.2	4
KLN 100-15	0 to 100	0 to 15	15	45	12	3.5	12	8	0.15	0.15	1.5	5
KLN 150-10	0 to 150	0 to 10	24	45	12	3.5	12	8	0.15	0.15	2	5
KLN 300-5	0 to 300	0 to 5	38	25	32	2.5	32	6	0.15	0.15	3	5
KLN 600-2.5	0 to 600	0 to 2.5	113	15	62	2.26	62	5.5	0.25	0.3	4	5

**NOTES:**

- Actual output voltage should be  $\leq 0.1\%$  of rated voltage when output voltage is set to zero.
- Actual output current should be  $\leq 0.2\%$  of the rated current when output current is set to zero (resistive load).
- Measured when output is within 10%-100% of rated value; ripple bandwidth: 300kHz (rms), noise bandwidth:  $<20\text{MHz}$  (p-p).
- For 6V model: measured when output voltage 2-6V and rated current; all other models measured when output 10-100% of rated voltage and rated current.
- Input voltage 100-240V a-c (190-240V a-c for 3000W models), 50/60Hz, constant load.
- Constant input voltage and output from no load to full load.
- With rated input, resistive load.
- Rated power output with input 115V or 230V a-c
- Specifications met after 30 minutes of operation, ambient temperature  $23\pm 5^\circ\text{C}$ , humidity under 80% R. H, nominal a-c input voltage  $\pm 5\%$ , THD  $\leq 2\%$ , not using the remote compensation, not operating in series or parallel.
- For example, the spec for KLN 6-100 line regulation and load regulation in CV mode is  $0.05\% + 2.8\text{mV}$  (or  $6 \times 0.0005 = 3\text{mV} + 2.8\text{mV} = 5.8\text{mV}$ ).
- Add G suffix for models with optional GPIB interface, add E suffix for optional LAN interface.
- Specifications subject to change without notice.

**TABLE 1-1. KLN SERIES MODEL PARAMETERS (CONTINUED)**

Model (8)(9)(11)(12)	d-c Output Range		Ripple <sup>(3)</sup>		Line Regulation <sup>(5)(10)</sup>		Load Regulation <sup>(10)</sup>		Response Time <sup>(7)</sup>			Remote Sense Voltage drop (max.)
	Constant Voltage (CV) <sup>(1)</sup>	Constant Current (CC) <sup>(2)</sup>	CV	CC <sup>(4)</sup>	CV	CC	CV <sup>(6)</sup>	CC <sup>(6)</sup>	Full Load Up	Full Load Down	No Load Down	
	V d-c	A d-c	mV rms	mA rms	0.05% +mV	0.1% +mA	0.05% +mV	0.1% +mA	Sec	Sec	Sec	
<b>3000W 2U Full Rack Models</b>												
KLN 6-400	0 to 6	0 to 400	23	1000	2.8	42	6.2	85	0.08	0.02	0.5	1
KLN 8-360	0 to 8	0 to 360	23	1000	2.8	42	6.2	85	0.08	0.02	0.5	1
KLN 12.5-240	0 to 12.5	0 to 240	23	800	3.2	29	7.1	60	0.08	0.1	0.8	1
KLN 20-150	0 to 20	0 to 150	23	600	4	18.5	8	38	0.08	0.1	0.8	1
KLN 30-100	0 to 30	0 to 100	23	310	5	13	9.5	27	0.08	0.16	0.9	1.5
KLN 40-76	0 to 40	0 to 76	23	250	6	10.5	11	22	0.08	0.16	1	2
KLN 50-60	0 to 50	0 to 60	23	200	7	9	13	19	0.08	0.16	1.1	2
KLN 60-50	0 to 60	0 to 50	23	150	8	7.5	14	16	0.08	0.16	1.1	3
KLN 80-38	0 to 80	0 to 38	23	110	10	6.2	17	13.4	0.15	0.3	1.2	4
KLN 100-30	0 to 100	0 to 30	23	90	12	5.3	20	11.6	0.15	0.3	1.5	5
KLN 150-20	0 to 150	0 to 20	36	90	17	4.2	27.5	9.4	0.15	0.3	2	5
KLN 300-10	0 to 300	0 to 10	57	50	32	3.1	50	7.2	0.15	0.3	3.5	5
KLN 600-5	0 to 600	0 to 5	170	30	62	2.55	95	6.1	0.25	0.5	4	5

NOTES:

- Actual output voltage should be  $\leq 0.1\%$  of rated voltage when output voltage is set to zero.
- Actual output current should be  $\leq 0.2\%$  of the rated current when output current is set to zero (resistive load).
- Measured when output is within 10%-100% of rated value; ripple bandwidth: 300kHz (rms), noise bandwidth: <20MHz (p-p).
- For 6V model: measured when output voltage 2-6V and rated current; all other models measured when output 10-100% of rated voltage and rated current.
- Input voltage 100-240V a-c (190-240V a-c for 3000W models), 50/60Hz, constant load.
- Constant input voltage and output from no load to full load.
- With rated input, resistive load.
- Rated power output with input 115V or 230V a-c
- Specifications met after 30 minutes of operation, ambient temperature  $23 \pm 5^\circ\text{C}$ , humidity under 80% R. H, nominal a-c input voltage  $\pm 5\%$ , THD  $\leq 2\%$ , not using the remote compensation, not operating in series or parallel.
- For example, the spec for KLN 6-100 line regulation and load regulation in CV mode is 0.05% + 2.8mV (or  $6 \times 0.0005 = 3\text{mV} + 2.8\text{mV} = 5.8\text{mV}$ ).
- Add G suffix for models with optional GPIB interface, add E suffix for optional LAN interface.
- Specifications subject to change without notice.

**TABLE 1-2. KLN GENERAL SPECIFICATIONS**

SPECIFICATION	RATING/DESCRIPTION
<b>INPUT CHARACTERISTICS</b>	
Input voltage	750W, 1500W: 100~240Vac, 50/60Hz <sup>(a)</sup> 127V~373V d-c <sup>(1)</sup> 3000W: 190~240Vac, 50/60Hz 254V~370V d-c <sup>(1)</sup>
Input current (Full load)	750W: 115Vac - 8.1A; 230V a-c - 4.1A 1500W: 115Vac - 16.2A; 230V a-c - 8.1A 3000W: 230V a-c - 15.6A
Inrush current	750W: 230Vac - 12.5A 1500W: 230Vac - 25A 3000W: 230Vac - 50A
Power Factor (PF) Typical	750W,1500W: 0.99 (at 115V a-c, rated output) 3000W: 0.99 (at 230V a-c, rated output)

(a) Below 100V a-c derate 15W per volt.

(1) Connect (+) to L and (-) to N. Safety agency approvals apply to a-c input operation only.

**TABLE 1-2. KLN GENERAL SPECIFICATIONS (CONTINUED)**

SPECIFICATION		RATING/DESCRIPTION
<b>OUTPUT CHARACTERISTICS</b>		
Type of Stabilizer		Constant Voltage (CV)/Constant Current (CC), automatic crossover
Adjustment Range	Voltage: Current:	0 to 100% of rated voltage 0 to 100% of rated current
Protective functions		Programmable overvoltage (OVP), Programmable overcurrent (OCP), Overtemperature (OTP), Fuse blown
Protection setting range	Overvoltage: Overcurrent:	0% to 110% of rated voltage 0% to 110% of rated current
Remote Error Sense Compensation		5V max. (See Table 1-1.)
Parallel Operation		Up to 5 units maximum, automatic load sharing
	Current sharing tolerance:	1% at rated current, 5% at 50% of rated current, 10% at less than 10% of rated current
Series Operation		2 units maximum (total voltage must not exceed 600V)
Temperature Coefficient	Constant Voltage Mode, Constant Current Mode:	100ppm/°C of rated output voltage or current, after 30 minute warm-up
Time (Drift)	Constant Voltage Mode, Constant Current Mode:	0.05% of rated output voltage or current over 8hrs interval following 30 minutes warm-up. Constant line, load and temperature.
Transient response time	Constant Voltage mode:	20V and under: ≤1.5ms; 30V~100V: ≤1ms 150V~600V: ≤2ms
Hold-up time		20ms
Efficiency	750W: 1500W: 3000W:	76% – 87% 77% – 88% 82% – 88%
Isolation Voltage	Input - Outputs: Input - Ground: Output - Ground (6V-150V) Output - Ground (300V-600V)	2000V a-c: 1 minute 2000V a-c: 1 minute 350V d-c, leakage current: 100µA 1200V d-c, leakage current: 100µA
<b>PROGRAMMING CHARACTERISTICS - LOCAL</b>		
Display resolution	Voltage and Current:	4 digits (setting and display)
Display setting accuracy	Voltage: Current:	±0.1% ± 3C <sup>(2)</sup> at rated voltage ±0.5% ± 3C <sup>(2)</sup> at rated current
Display reading accuracy	Voltage: Current:	±0.2% ± 3C <sup>(2)</sup> at rated voltage ±0.5% ± 3C <sup>(2)</sup> at rated current

(2) C = 1 count of the last displayed digit.

**TABLE 1-2. KLN GENERAL SPECIFICATIONS (CONTINUED)**

SPECIFICATION		RATING/DESCRIPTION
<b>PROGRAMMING CHARACTERISTICS - DIGITAL</b>		
Command setting resolution		±0.002% of full scale
Command reading resolution		±0.002% of full scale
Command and D/A setting accuracy	Voltage: Current:	±0.1% ± 3C <sup>(3)</sup> at rated voltage ±0.5% ± 3C <sup>(3)</sup> at rated current
Command and A/D Measurement accuracy	Voltage: Current:	±0.2% ± 2C <sup>(3)</sup> at rated voltage (Average Measurement) ±0.5% ± 3C <sup>(3)</sup> at rated current (Average Measurement)
Command response time		≤20ms (After received) <sup>(4)</sup>
RS-485 Digital Interface (standard)	Baud rate:	Select 4.8K, 9.6K, 19.2K, 38.4K, 57.6K, or 115K (max)
	Max number of units connected to bus:	254
	Max. effective control distance:	1000 meters.
GPIB Digital Interface		Optional
LAN Digital Interface		Optional
<b>PROGRAMMING CHARACTERISTICS - ANALOG</b>		
Analog setting accuracy		
Constant Voltage mode (CV):	Voltage: Current:	± 5% ± 5%
Constant Current mode (CC):	Voltage: Current:	± 5% ± 5%
Analog monitor accuracy	Rated voltage output:	10.00V ± 0.25V
	Zero voltage output:	0.00V ± 0.25V
	Rated current output:	10.00V ± 0.25V
	Zero current output:	0.00V ± 0.25V
<b>PHYSICAL CHARACTERISTICS</b>		
Weight	750W:	Less than 11.2 lbs (5.1 Kg)
	1500W:	Less than 19.84 lbs (9.0 Kg)
	3000W:	Less than 33.3 lbs (15.1 Kg)
Dimensions	750W:	8.46"W x 1.73"H x 18.5"D (215mm x 44mm x 470mm) See Figure 1-2
	1500W:	16.93"W x 1.73H x 18.5"D (430mm x 44mm x 470mm) See Figure 1-3
	3000W:	16.93"W x 3.46"H x 18.5"D (430mm x 88mm x 470mm) See Figure 1-4
Source Power Connector	750W:	IEC 320 inlet
	1500W, 3000W:	3-position terminal block
Load Connections	6V to 100V:	± bus bars with protective cover
	150V to 600V (750W):	5-position Euroblock
	150V to 600V (1500W, 3000W):	4-position terminal block

(3) C = 1 count of the last displayed digit.

(4) Programming time = Command response time + Output response time. The output response time differs for different models, see Table 1-1. The analog programming input signal goes directly to the analog circuitry, so there is no command response time delay for analog programming.

**TABLE 1-2. KLN GENERAL SPECIFICATIONS (CONTINUED)**

SPECIFICATION		RATING/DESCRIPTION
<b>PHYSICAL CHARACTERISTICS - CONTINUED</b>		
Programming Control port		26-pin connector
SER IN port		2-position Euroblock (mating connector supplied)
Sense port		3-position Euroblock (mating connector supplied)
RS-485 port		3-position Euroblock (mating connector supplied)
LAN port (optional)		RJ 45 connector
GPIB port (optional)		Standard IEEE 488.2 GPIB connector
<b>GENERAL (ENVIRONMENTAL) SPECIFICATIONS</b>		
Temperature	Operating: Storage:	0 to 50°C (indoor use) -20 to 70°C
Humidity	Operating: Storage:	30%~90% RH (no condensation) 10%~90% RH (no condensation)
Altitude		3000m max
Cooling		Speed-Controlled Fans
Noise		<70 dB (A)
EMC Standard		EN 61326-1:2006
EMC Emissions (EN 61326-1)	Conducted Disturbance:	EN 55011:2007 +A2:2007 Class B
	Radiated Disturbance:	EN 55011:2007 +A2:2007 Class B
	Harmonic Distortion:	EN 61000-3-2:2006 Class A
	Voltage Fluctuations and Flicker:	EN 61000-3-3:2008 Section 5
EMC Immunity (EN 61326-1)	Electrostatic Discharge (ESD):	EN 61000-4-2:2009 Class B
	Radiated RF Magnetic Field:	EN 61000-4-3:2006 + A1:2008 + A2:2010 Class A
	Electrical Fast Transients and Bursts:	EN 61000-4-4:2004 + A1:2010 Class B
	Surge:	EN 61000-4-5:2006 Class B
	Conducted Disturbance Induced by RF Fields:	EN 61000-4-6:2009, Class A
	Voltage Dips and Short Interruptions:	EN 61000-4-11:2004, Class C
Vibration Testing (1 hour)	Frequency: Acceleration: PSD (Power Spectral Density): Test Axis:	1Hz to 200Hz 1.146g rms 0.0001g <sup>2</sup> /Hz (1 Hz), 0.01g <sup>2</sup> /Hz (4 Hz, 100 Hz), 0.001g <sup>2</sup> /Hz (200 Hz) X/Y/-Z (10 mins.), +Z (30 mins.)

**NOTE:**

All specifications apply after power on for 30 minutes, ambient temperature: 23±5°C, Humidity: under 80% RH, AC Voltage: ±5%, Frequency: ±5%.



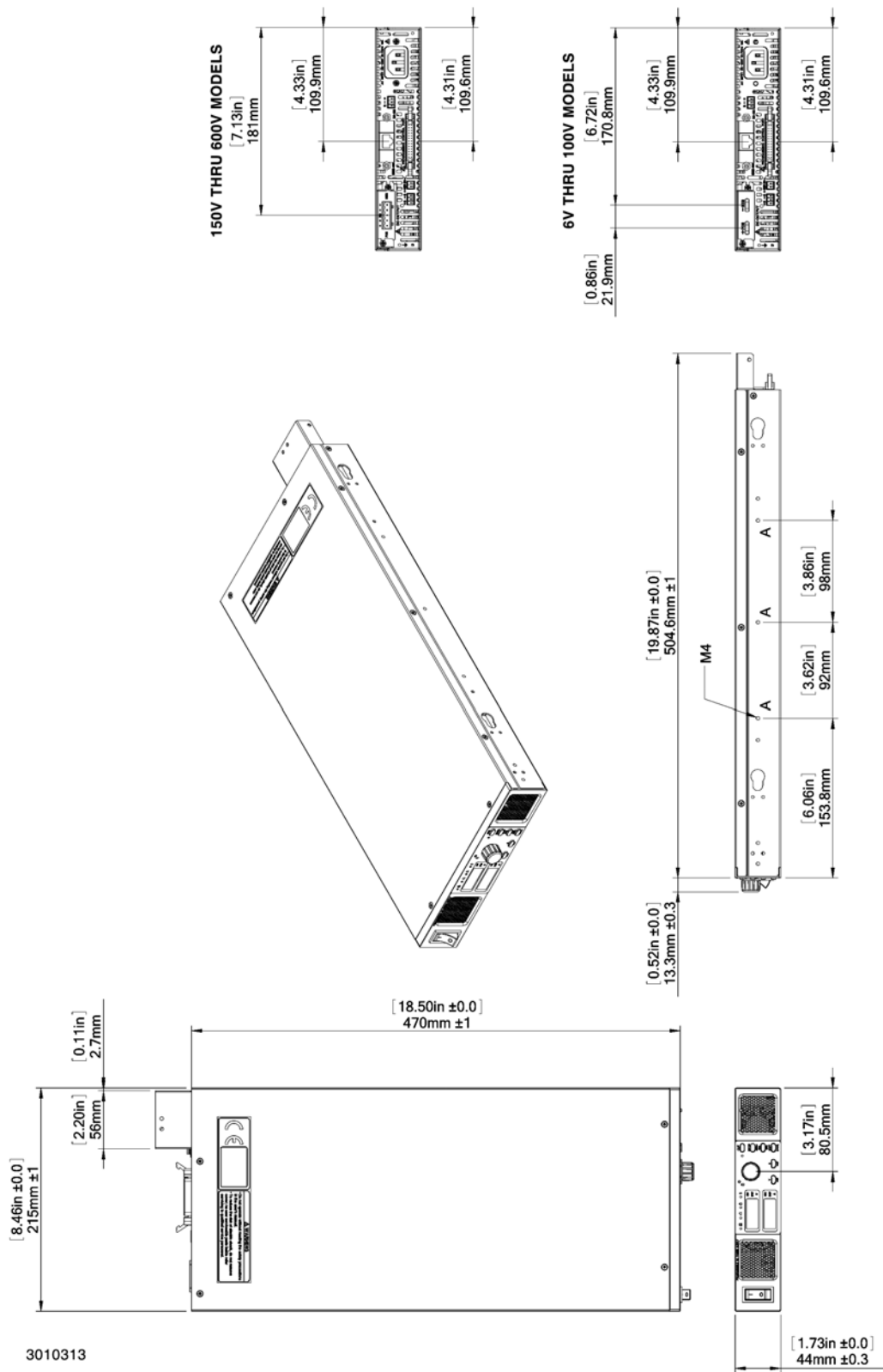
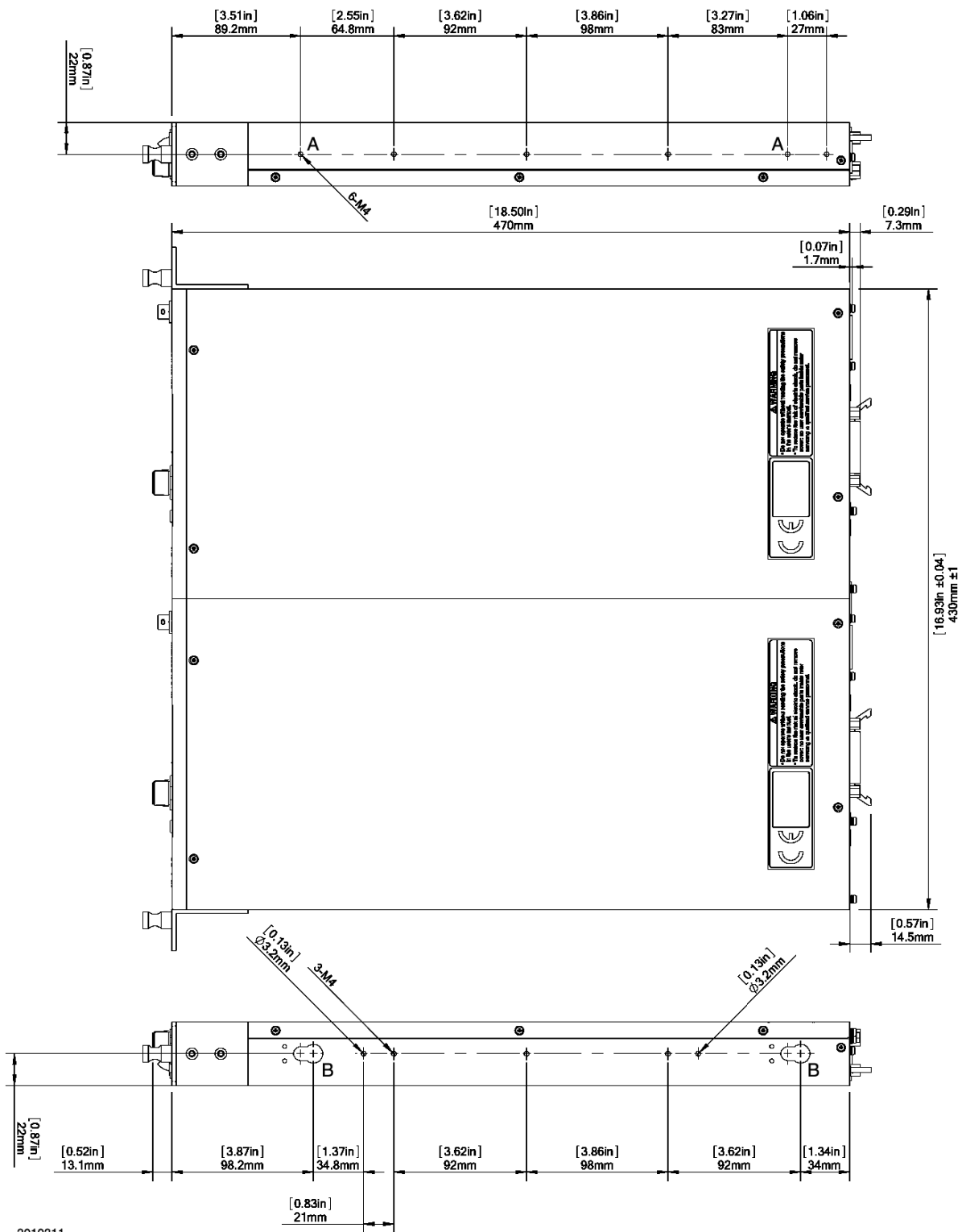
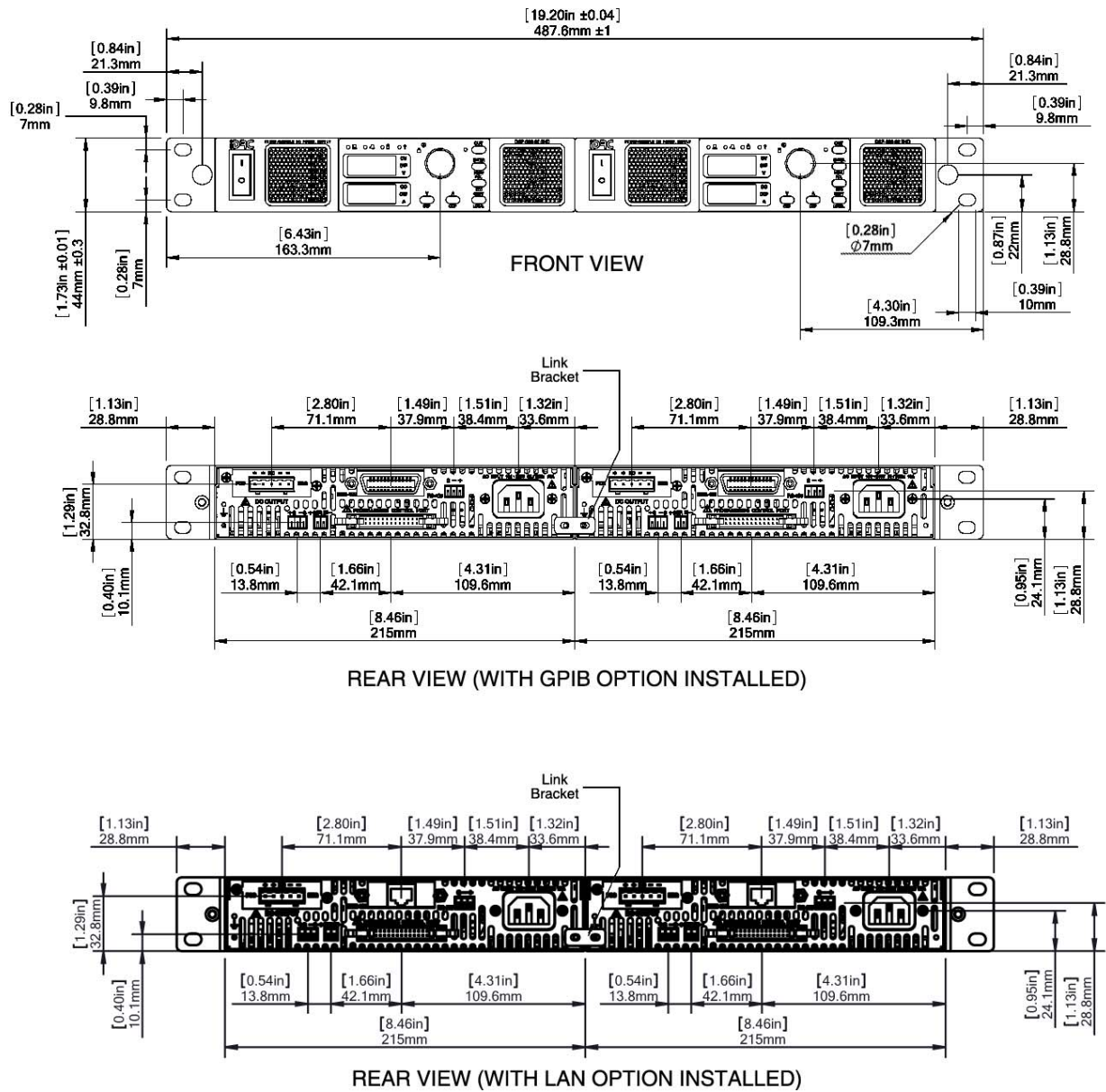

FIGURE 1-2. KLN 750W POWER SUPPLY, OUTLINE DRAWING



3010311

FIGURE 1-2. KLN 750W POWER SUPPLY, OUTLINE DRAWING (TWO UNITS MOUNTED IN RACK)  
(SHEET 1 OF 2)



30103112

NOTE: 150V MODELS SHOWN.

FIGURE 1-2. KLN 750W POWER SUPPLY, OUTLINE DRAWING (SHEET 2 OF 2)

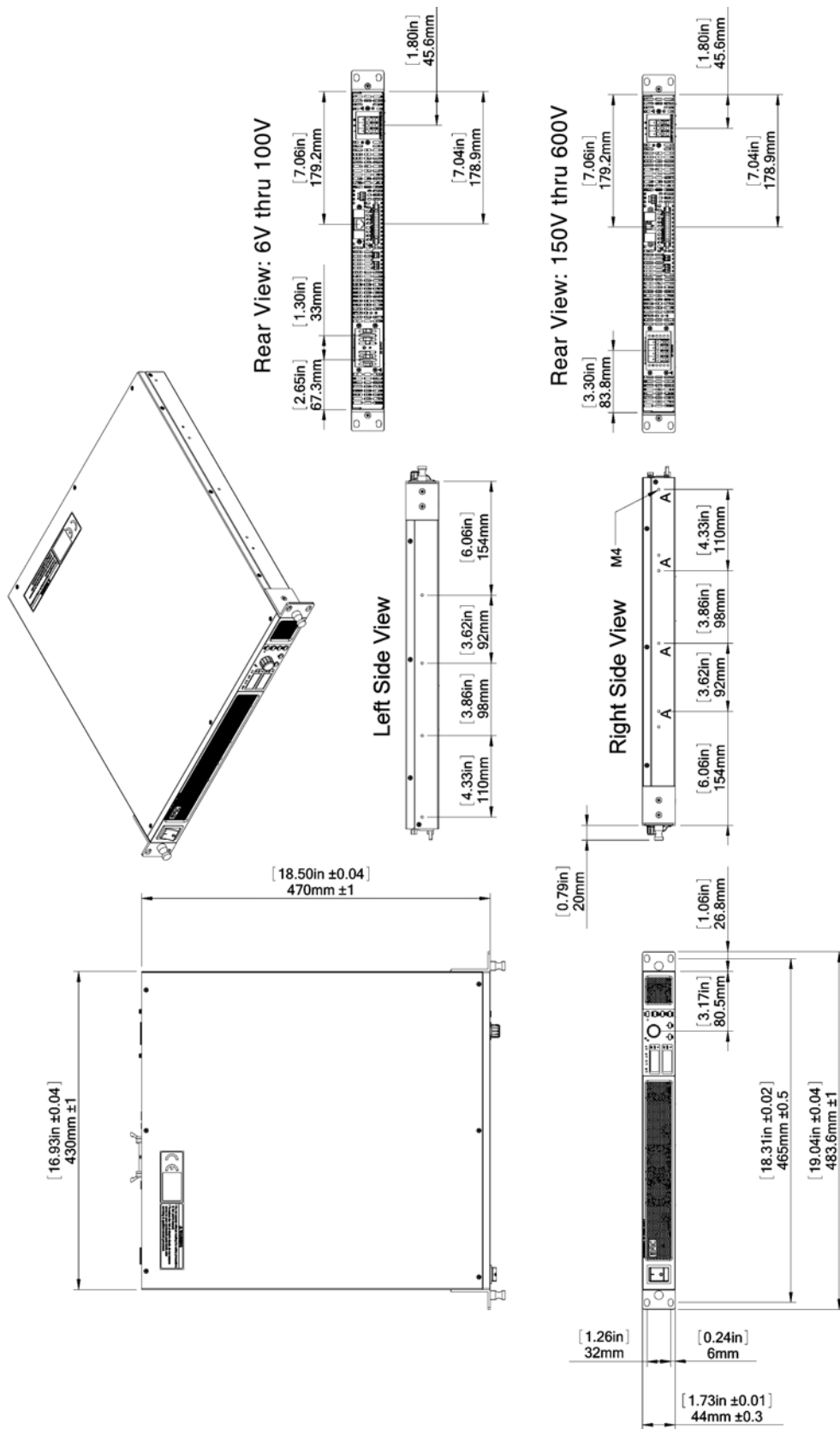

3010314

FIGURE 1-3. KLN 1500W POWER SUPPLY, OUTLINE DRAWING SD

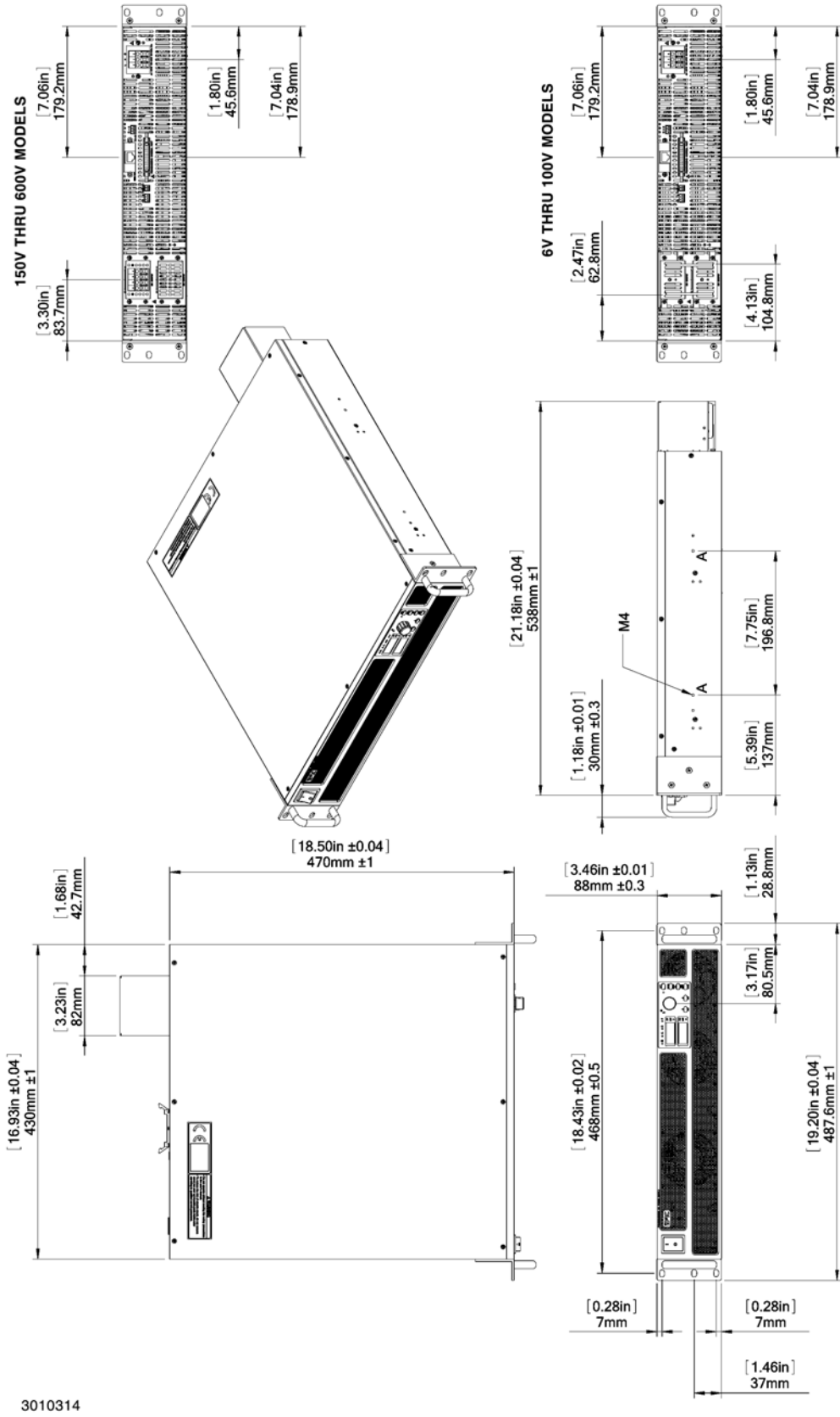

FIGURE 1-4. KLN 3000W POWER SUPPLY, OUTLINE DRAWING

## **1.4 LOCAL CONTROL**

The front panel encoder can set and adjust output voltage and current under local control. The display uses two 4-digit LED displays to provide a digital readout of output voltage and current.

## **1.5 REMOTE CONTROL**

The KLN Power Supply can be remotely controlled directly via the built-in RS-485 interface using SCPI commands (see Appendix A and B). Most features available in local mode can also be accessed remotely via the RS-485 (standard), and GPIB (optional) or LAN (optional) digital interfaces. The transmission rate of RS-485 can be up to 115.2K bps. The RS-485 interface can be used to connect multiple power supplies, up to a maximum of 254 units. The maximum effective control distance can be up to 1000m.

Digital remote control is also available via optional GPIB (suffix G) and LAN (suffix E) interfaces.

## **1.6 ANALOG CONTROL**

External reference signals, provided through the Programming Control port (see Table 2-4), can be used to control the output voltage and current of the KLN. The Programming Control port allows control of output on/off and permits emergency shutdown of the output. Output signals allow remote monitoring of whether the unit is powered on, output on/off, alarm condition, output voltage and current, and operating mode: Constant Current (CC) or Constant Voltage (CV). Refer to PAR. 3.5 for further details on using external signals to control and monitor the output.

## **1.7 FEATURES**

### **1.7.1 DIGITAL CALIBRATION**

The KLN Power Supply features high stability and long intervals between calibration. The unit contains no user-required internal adjustments. Calibration is done by means of software (see Section 4).

### **1.7.2 PROTECTION**

The following protection is provided: OVP (Overvoltage protection), OCP (overcurrent protection), OTP, (overtemperature protection) and blown fuse.

### **1.7.3 SAVING AND RECALLING SETTINGS**

The KLN offers 16 memory locations accessible from the front panel that can be used to store a set of operating parameters for later use. For each location, the user can store voltage and current values. The stored settings can then be recalled to quickly program the unit to the predetermined setting. Refer to PAR. 3.3.6 and 3.3.7 for further details.

### **1.7.4 PARALLEL AND SERIES CONFIGURATIONS**

Identical KLN units may be configured in series (up to two units including master) or parallel (up to five units including master) configurations. Parallel configurations provide for automatic current sharing (see PAR. 2.8 for details).









## 1.7.5 MISCELLANEOUS FEATURES

- Both positive and negative output ramps can be independently programmed (see PAR's. 3.3.10 and 3.3.11).
- Last setting is automatically restored upon power-up. Output can be programmed to be either on or off upon power-up (see PAR's. 3.3.9).
- One key recall of up to 16 memory locations storing voltage and current settings (see PAR's. 3.3.39 and 3.3.7).
- Variable speed fans reduce noise and extends fan life.
- Non-gap stacking; No ventilation holes at top or bottom.
- CE Mark approved.
- Approved as compliant to LXI Version 1.4, Device Specification 2011.





## 1.8 EQUIPMENT SUPPLIED

Equipment supplied with the KLN power supply is listed in Table 1-3.

**TABLE 1-3. EQUIPMENT SUPPLIED**

ITEM	DESCRIPTION		KEPCO PART NUMBER
Power Cable, (125V/15A) (750W only)	Connects unit to 115V a-c source power.		118-0557
Power Cable (1500W, 3000W only)	Connects unit to 230V a-c source power.		518-0120
Sense wires: Red (6V - 100V models)	Used to connect output to local sensing connections: red: (+) to +S, black: (-) to -S		118-1302
Sense wires: Red (150V - 600V models)	Used to connect output to local sensing connections: red: (+) to +S, black: (-) to -S		118-1304
Sense wires: Black (6V - 100V models)	Used to connect output to local sensing connections: red: (+) to +S, black: (-) to -S		118-1303
Sense wires: Black (150V - 600V models)	Used to connect output to local sensing connections: red: (+) to +S, black: (-) to -S		118-1305
Mating connectors (RS-485 and Sense)	One supplied installed on RS-485 port to allow access to RS 485 interface; one supplied installed on Sense connector to provide access to sense connections used to compensate for voltage drop on load connections		542-0037
Programming Control Port cover	Supplied installed on Programming Control port to protect programming port pins.		137-0155

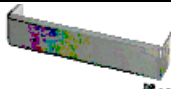

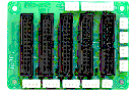
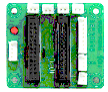



**TABLE 1-3. EQUIPMENT SUPPLIED (CONTINUED)**

ITEM	DESCRIPTION		KEPCO PART NUMBER
SER IN mating connector	Supplied installed on SER IN connector to allow series connection of two units.		542-0036
Output Terminal Protective Cover (750W, 6V-100V models only)	Used to protect output terminals during transit.		137-0156
Output Terminal Mating Connector (750W, 150V-600V models only)	Supplied installed on output terminals to allow convenient load connections.		142-0603
Rack Mount Kit (L-type Brackets (2) with mounting screws (4) (750W, 1500W models only)	Allows mounting of one 1U full rack KLN 1500W unit in standard 19-inch rack. 750W units require optional rack mounting Kit RA 81-1 or RA 81-2 to install one or two units, respectively, in 19-inch rack.		128-2428
Rack Mount Kit L-type Brackets (2) with mounting screws (6) (3000W models only)	Allows mounting of one 2U full-rack KLN 3000W unit in standard 19-inch rack.		128-2430

**1.9 ACCESSORIES**

Accessories (not supplied) for the KLN Power Supply are listed in Table 1-4.

**TABLE 1-4. ACCESSORIES**





ITEM	FUNCTION		PART NUMBER
Rack Mount Kit (750W models only)	Allows mounting of one half-rack KLN 750W unit in standard 19-inch rack (L-type brackets supplied with unit, not included in Kit).		RA 81-1 (Kepco)
Rack Mount Kit (750W models only)	Allows mounting of two half-rack KLN 750W units side-by-side in standard 19-inch rack (L-type brackets supplied with unit, not included in Kit).		RA 81-2 (Kepco)
Parallel Connector Board	Provides convenient connections for parallel operation of up to five units		536-0129 (Kepco)
Series Connector Board	Provides convenient connections for series operation of two units.		536-0130 (Kepco)
Programming Port Cable	Provides connections between two programming ports for parallel and series operation.		518-0119 (Kepco)
Side Support Bracket (pair), 14.95 in. long	Provides side support for rack-mounted units. Recommended for 3000W KLN Series.		RASA16BK3 (Hammond)
Parallel Connection Cable (2 Units), 15cm long	Connects PROGRAMMING CONTROL port of two units to provide parallel connections without the need for a Parallel Connector Board.		518-0121 (Kepco)
Chassis Slides	Allows installation of full rack 1U and 2U KLN models in standard 19-inch wide cabinet (30 inches deep, minimum).		Model CS 07 (Kepco)



**1.10 SAFETY**

Service must be referred to authorized personnel. Using the power supply in a manner not specified by Kepco. Inc. may impair the protection provided by the power supply. Observe all safety precautions noted throughout this manual (see listing on Safety page A, preceding the Table of Contents). Table 1-5 lists symbols used on the power supply or in this manual where applicable.

**TABLE 1-5. SAFETY SYMBOLS**

<b>SYMBOL</b>	<b>Meaning</b>
	WARNING! RISK OF ELECTRIC SHOCK!
	CAUTION: REFER TO REFERENCED PROCEDURE.
	FRAME OR CHASIS TERMINAL
	GROUND TERMINAL
	PROTECTIVE GROUND CONDUCTOR TERMINAL
WARNING	INDICATES THE POSSIBILITY OF BODILY INJURY OR DEATH.
CAUTION	INDICATES THE POSSIBILITY OF EQUIPMENT DAMAGE.



## SECTION 2 - INSTALLATION

### 2.1 UNPACKING AND INSPECTION

This instrument has been thoroughly inspected and tested prior to packing and is ready for operation. After careful unpacking, inspect for shipping damage before attempting to operate. Perform the preliminary operational check as outlined in PAR. 2.3. If any indication of damage is found, file an immediate claim with the responsible transport service.

### 2.2 TERMINATIONS AND CONTROLS

a) Front Panel: Refer to Figure 3-1 (750W), 3-2 (1500W) or 3-3 (3000W) and Table 3-1.

b) Rear Panel: Refer to Figure 2-1 (750W), 2-2 (1500W) or 2-3 (3000W) and Table 2-1.

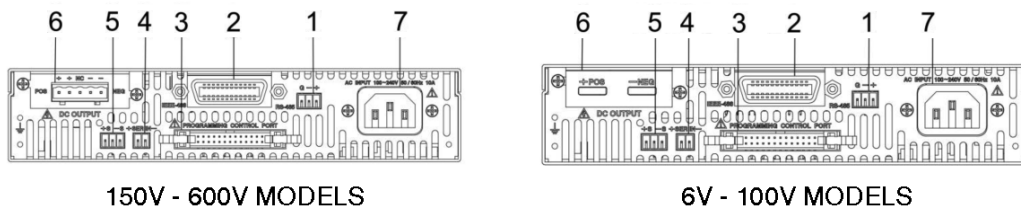

3043655

**FIGURE 2-1. KLN 750W SERIES REAR PANEL**

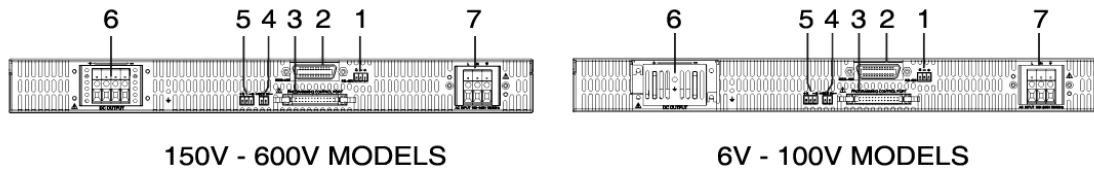

3043725

**FIGURE 2-2. KLN 1500W SERIES REAR PANEL**

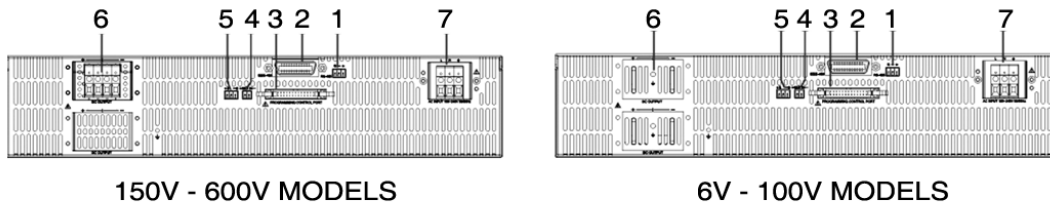

3043724

**FIGURE 2-3. KLN 3000W SERIES REAR PANEL**

**TABLE 2-1. REAR PANEL CONNECTOR FUNCTIONS**

NUMBER (FIGURE 2-1, 2-2 or 2-3)	CONNECTOR/TERMINAL	FUNCTION
1	RS-485 3-pin pluggable terminal block	Allows connection to RS-485 bus. See Table 2-2 for details.
2	Optional: either 24-pin GPIB connector or LAN ethernet connector (see Figure 2-4)	Allows connection to GPIB bus or LAN (optional) when installed. See Table 2-3 for GPIB connector details. Green LAN status indicator blinks when IDN? query received, stays on steady to indicate normal LAN operation, and is off when not connected to the LAN or a LAN fault has occurred.
3	Programming Control Port	Allows access to analog input/output signals that allow monitoring and control of the power supply by analog means. See Table 2-4 for pin assignments.
4	SER IN	Provides output voltage reference from master to slave to ensure voltage slave matches the master when two units connected in series.
5	+S, -S	Remote sensing voltage compensation.
6	DC Output	Allows connection to load.
7	AC input	Allows connection to mains supply using power cord supplied.

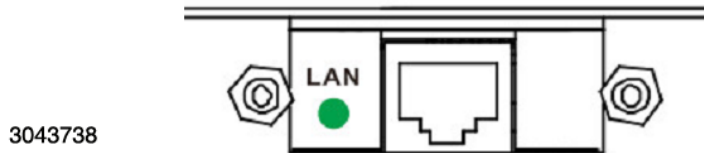

**FIGURE 2-4. LAN ETHERNET CONNECTOR (LAN INTERFACE ONLY)**

**TABLE 2-2. RS-485 PORT INPUT/OUTPUT PIN ASSIGNMENTS**

PIN (FIGURE 2-5)	SIGNAL NAME	FUNCTION
G	Ground	Reduce external interference
+	+RX	Connect to +TX of computer and/or +RX of next unit on RS-485 bus (see Figure 2-15).
-	-RX	Connect to -TX of computer and/or -RX of next unit on RS-485 bus (see Figure 2-15).

NOTE: Connect 120 Ohm termination resistor across + and - of last unit connected to RS-485 bus (furthest from computer)  
See PAR. 2.7.2.



**FIGURE 2-5. RS-485 PORT**

**TABLE 2-3. GPIB (IEEE 488) PORT INPUT/OUTPUT PIN ASSIGNMENTS**

PIN	SIGNAL NAME	FUNCTION
1	DI01	I/O Line
2	DI02	I/O Line
3	DI03	I/O Line
4	DI04	I/O Line
5	EOI	End or Identify
6	DAV	Data Valid
7	NRFD	Not Ready for Data
8	NDAC	Not Data Accepted
9	IFC	Interface Clear
10	SRQ	Service Request
11	ATN	Attention
12	SHIELD	Shield
13	DI05	I/O Line
14	DI06	I/O Line
15	DI07	I/O Line
16	DI08	I/O Line
17	REN	Remote Enable
18	GND	Ground (signal common)
19	GND	Ground (signal common)
20	GND	Ground (signal common)
21	GND	Ground (signal common)
22	GND	Ground (signal common)
23	GND	Ground (signal common)
24	LOGIC GND	Logic Ground

**TABLE 2-4. PROGRAMMING CONTROL PORT I/O PIN ASSIGNMENTS**

PIN (FIGURE 2-6)	SIGNAL NAME	FUNCTION
1, 2	RECALL	External recall control (dry contact). Same function as RCL key on front panel.
3, 4, 5, 6	---	Not used
7	Power on/off status	Output signal. Active (low between pin 7 and pin 8) to indicate unit is turned on. <sup>(1)</sup>
8	Status common	Common for Status signal pins 7, 9, 10, 11 and 12 <sup>(1)</sup>
9	Alarm status	Output signal. Active (low between pin 9 and pin 8) to indicate whether alarm (OVP or OCP trips or shutdown signal applied to pin 23) has occurred. (open collector via optocoupler). <sup>(1)</sup>
10	On/off status	Output signal. Active (low between pin 10 and pin 8) to indicate output is on (open collector by optocoupler). <sup>(1)</sup> (See PAR. 3.3.38 to enable.)
11	CC status	Output signal. Active (low between pin 11 and pin 8) to indicate unit is in constant current mode (open collector by optocoupler). <sup>(1)</sup>
12	CV status	Output signal. Active (low between pin 12 and pin 8) to indicate unit is in constant voltage mode (open collector by optocoupler). <sup>(1)</sup>
13	EXT +5V input (isolated ON/OFF)	External input signal, isolated from input and output. External +5V signal (referenced to pin 14) turns output ON. Output is ON when activated by either pin 13 or pin 21. To activate this function, refer to PAR. 3.3.38 and set External Control of Output On/Off (Eo.C) to ON.
14	EXT V input common	Common for Pin 13 (remote output on/off function).

**TABLE 2-4. PROGRAMMING CONTROL PORT I/O PIN ASSIGNMENTS (CONTINUED)**

PIN (FIGURE 2-6)	SIGNAL NAME	FUNCTION
15	PRL IN+	Input signal. Used to bring Current Sharing signal from MASTER to SLAVE(s) to force current sharing between units operating in parallel (see PAR. 2.8.2).
16	EXT CV	Input signal. External voltage to control output voltage of unit. 0 to 10V d-c corresponds to zero to full scale output voltage (see PAR. 3.3.39 to enable).
17	PRL OUT+	Output signal. Current Sharing signal sent from MASTER to SLAVE(s) to force current sharing between units operating in parallel (see PAR. 2.8.2).
18	EXT CC	Input signal. External voltage to control output current of unit. 0 to 10V d-c corresponds to zero to full scale output current (see PAR. 3.3.40 to enable).
19	PRL IN-/OUT-	V common for pins 15 and 17. Connected to -OUT
20	V Monitor	Output signal. Zero to 10V d-c corresponds to zero to full scale voltage,
21	ON/OFF Control (non-isolated)	Input Signal. Used to turn output ON (short to pin 25) or OFF (open). non-isolated. Dry contact. Output is ON when activated by either pin 21 or pin 13. To activate this function, refer to PAR. 3.3.38 and set External Control of Output On/Off (Eo.C) to ON.
22	A Monitor	Output signal. Zero to 10V d-c corresponds to zero to full scale current.
23	Shutdown	Short between pin 23 and pin 25 causes emergency shutdown of output (output OFF). Unit beeps, alarm LED (red) goes ON, and error 77 is generated. Overrides pin 21 (non-isolated) and pin 13 (isolated) ON/OFF control.
24, 26	Analog Common	Analog signal control ground, connected to pin 19.
25	Digital Common	Digital signal control ground.
(1) Open collector output: maximum voltage 30V, maximum current 8mA; Low: <0.4V.		

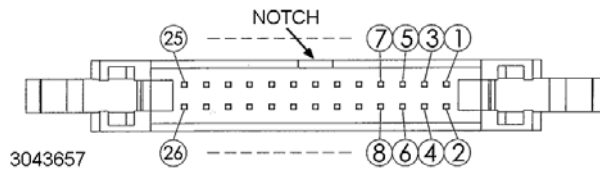





**FIGURE 2-6. PROGRAMMING CONTROL PORT**

### 2.3 PRELIMINARY OPERATIONAL CHECK

A simple operational check after unpacking and before equipment installation is advisable to ascertain whether the power supply has suffered damage resulting from shipping.

Refer to Figure 2-1, 2-2 or 2-3 and Figure 3-1, 3-2, or 3-3 for location of operating controls and electrical connections. Tables 3-1 and 3-2 explain the functions of operating controls/indicators and keypad keys, respectively. Refer to PAR. 3.2 for a description of basic operating techniques.

1. With power supply disconnected from source power verify that sense connections are correct: +S is connected to +POS and -S is connected to -NEG (see Figure 2-12).
2. With front panel power circuit breaker to OFF position, connect the power supply to source power (see PAR. 2.5.2).
3. With no load connected, set power circuit breaker to ON. Each time the unit is turned on it beeps and an internal self-test is performed (see PAR 3.2.1). After the test has been successfully completed, the 4-digit Voltage Display and Current Display show the last programmed voltage and current values, respectively, in Volts and Amperes.

4. Press **SHIFT/LOCAL** key. Verify blue  LED goes on. Press **V/OVP** key: Least significant digit of Voltage Display and integral red OVP LED at the right of the display blink. Verify blue  LED goes off.
5. Rotate encoder to change the digits for adjustment. Turn clockwise to increase the value, counterclockwise to decrease the value. Tap encoder to move to the next digit. Continue until the maximum OVP value is displayed (e.g., 33.00 for 30V model).
6. Press **ENTER** key to accept programmed OVP value.
7. Press **SHIFT/LOCAL** key. Verify blue  LED goes on. Press **A/OCP**. Least significant digit of Current Display and integral red OCP LED at the right of the display blink. Verify blue  LED goes off.
8. Rotate encoder to change the digits for adjustment. Turn clockwise to increase the value, counterclockwise to decrease the value. Tap encoder to move to the next digit. Continue until the maximum OCP value is displayed (e.g., 26.25 for 25 Ampere model).
9. Press **ENTER** key to accept programmed OCP value.
10. Press **V/OVP** key. Least significant digit of Voltage Display blinks.
11. Rotate encoder to change the digits for adjustment. Turn clockwise to increase the value, counterclockwise to decrease the value. Tap encoder to move to the next digit. Continue until the rated output voltage value (e.g., 30.00 for 30V model) is displayed.
12. Press **ENTER** key to accept programmed voltage value.
13. Press **A/OCP** key. Least significant digit of Current Display blinks.
14. Rotate encoder to change the digits for adjustment. Turn clockwise to increase the value, counterclockwise to decrease the value. Tap encoder to move to the next digit. Continue until a value of several Amperes of output current is displayed.
15. Connect a digital voltmeter (DVM) to the (+S) and (-S) terminals on the rear panel. Verify that DVM shows there is no output voltage from the power supply.
16. Press green **OUT** key. Verify that green LED at left of **OUT** key goes on.
17. Compare the programmed output voltage value (e.g., 30.00V for 30V model per step 11) with the voltage reading of the DVM; Verify that the difference between the two does not exceed  $\pm 0.1\% \pm 3C^{(*)}$ .
18. Compare the voltage reading of Voltage Display with that of the DVM; Verify that the difference between the two does not exceed  $\pm 0.2\% \pm 3C^{(*)}$ .
19. Disable the output by pressing the **OUT** key; verify front panel Voltage and Current displays show programmed values of Voltage and Current, respectively and DVM reads 0V.
20. Set power switch to **OFF**. The unit issues a long beep as it powers down. Disconnect unit from source power, then disconnect test equipment.

(\*) C = 1 count of the last displayed digit.

## 2.4 INSTALLATION

### 2.4.1 RACK MOUNTING 750W MODELS

One or two (side by side) KLN 750W units can be mounted in a standard 19-inch rack (see Figure 1-2 for outline dimensions). The units are 1U high and do not require any gaps between equipment above and below. Airflow is front to back only. Use the optional RA 81-1 Mounting Kit (see Table 1-5) to mount a single unit. Use optional Mounting Kit RA 81-2 (see Table 1-5) to mount two half-rack units side by side in a 19-inch rack.

#### 2.4.1.1 MOUNTING ONE 750W 1/2-RACK UNIT IN 19-INCH RACK

1. On one side of the unit, mount one L-type bracket with knob (supplied with unit) to the unit using two screws supplied with unit (see Figure 2-7).
2. Mount the U-type bracket supplied in the Kit to the other side of the unit using two screws supplied in Kit.
3. Mount the other L-type bracket with knob (supplied with unit) to the end of the U-type bracket using two screws supplied with unit. The knobs can now be used to support the assembled unit while installing in a 19-inch rack.

**NOTES:**

1. PARTS SUPPLIED WITH KLN MODEL.
2. PARTS SUPPLIED WITH RA 81-1 RACK ADAPTER.

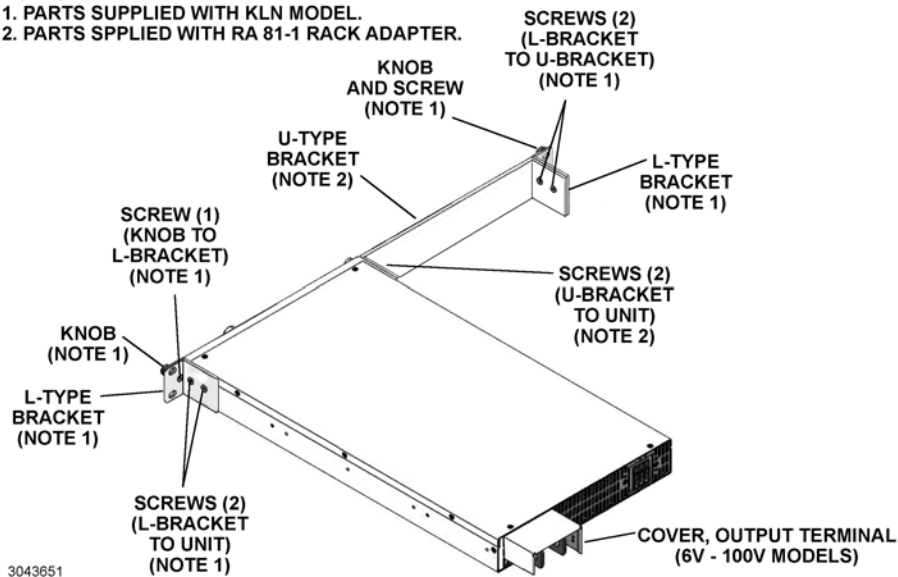

**FIGURE 2-7. MOUNTING ONE KLN 750W UNIT IN 19-INCH RACK**



### 2.4.1.2 MOUNTING TWO 750W 1/2-RACK UNITS IN 19-INCH RACK

To mount two KLN 750W units side-by-side in a 19 inch rack, use the RA 81-2 mounting kit (not supplied, see Accessories, Table 1-5).

1. Place the two units side by side as they would be installed in the rack. On the outer side of each unit (not facing the other unit), mount one L-type bracket with knob (supplied with unit) to each unit using two screws supplied with unit for each (see Figure 2-8).
2. Separate the two units. Install two shoulder screws, flat washers and lockwashers (supplied with Kit) at two locations on one unit (two threaded holes, A, Figure 1-2).
3. Move the two units together and insert the shoulder screws into the keyhole-shaped opening in the other unit (two holes, B, Figure 1-2). Then slide the unit with the shoulder screws forward until the front panels of both units are flush.
4. Connect the two units at the rear using linking bracket (see Figure 1-2, sheet 2) and two screws supplied with Kit. The two units can now be handled as an assembly and can be installed directly into a 19-inch rack.

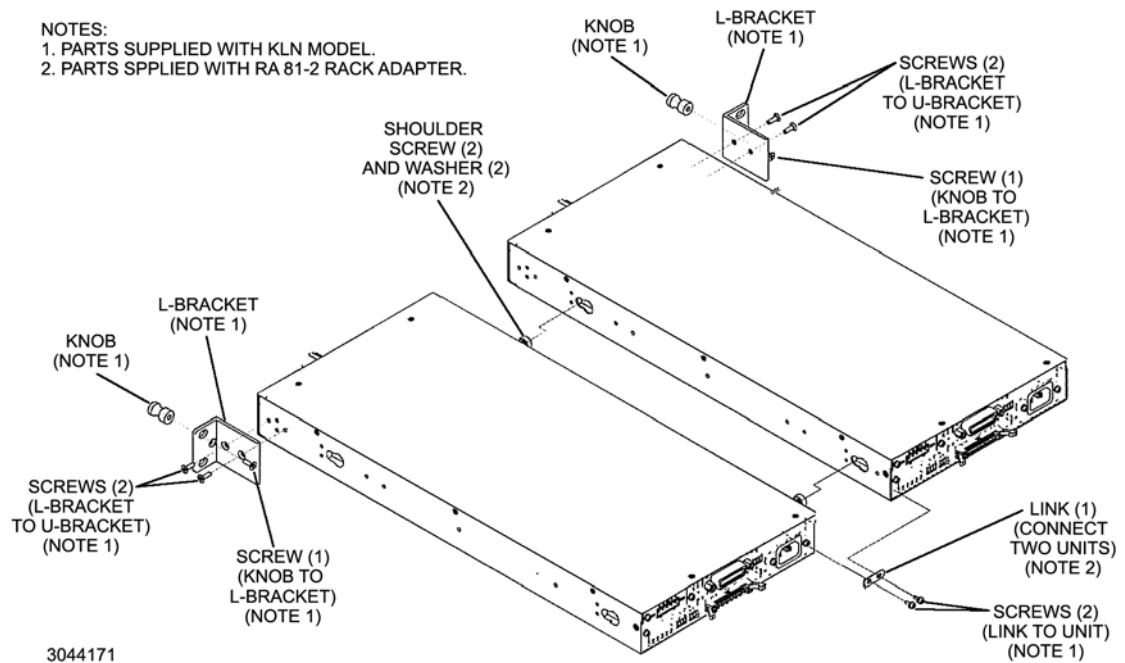

FIGURE 2-8. MOUNTING TWO KLN 750W UNITS IN 19-INCH RACK

## 2.4.2 RACK MOUNTING 1500W MODELS

KLN 1500W units can be mounted in a standard 19-inch rack using the Mounting Kit supplied with the unit (see Figure 1-3 for outline dimensions). Knobs are preassembled to the two L-type brackets using two screws supplied in the kit. On each side of the unit, attach the two L-type brackets with knobs to the unit using four screws supplied in the Kit. The units are 1U high and do not require any gaps between equipment above and below. Airflow is front to back only.

## 2.4.3 RACK MOUNTING 3000W MODELS

KLN 3000W units can be mounted in a standard 19-inch rack using the Mounting Kit supplied with the unit (see Figure 1-4 for outline dimensions). On each side of the unit, attach the two L-type brackets with handles to the unit using six screws supplied in the Kit. The units are 2U high and do not require any gaps between equipment above and below. Airflow is front to back only. Side support brackets (not supplied, see Table 1-4, Accessories) are recommended to support the weight of the unit.

## 2.5 WIRING INSTRUCTIONS

Interconnections between an a-c power source and a power supply, and between the power supply and its load are as critical as the interface between other types of electronic equipment. If optimum performance is expected, certain rules for the interconnection of source, power supply and load must be observed by the user. These rules are described in detail in the following paragraphs.

**CAUTION: WHEN WORKING WITH ACTIVE LOADS, THE VOLTAGE OR CURRENT OF THE ACTIVE LOAD MUST NOT EXCEED THE MAXIMUM VOLTAGE OR CURRENT RATING OF THE KLN. OTHERWISE THE OVERVOLTAGE OR OVERCURRENT PROTECTION WILL SHUT DOWN THE POWER SUPPLY.**

### 2.5.1 SAFETY GROUNDING

To minimize shock hazard, the product chassis must be connected to an electrical ground. The product must be connected to the AC power supply mains through a three-conductor power cable, with the ground wire firmly connected to an electrical ground (safety ground) at the power outlet.

Local, national and international safety rules dictate the grounding of the metal cover and case of any instrument connected to the a-c power source, when such grounding is an intrinsic part of the safety aspect of the instrument. The ground terminal of the source power connector (Figure 2-1) is connected to the chassis and the instructions below suggest wiring methods which comply with these safety requirements. In the event that the specific installation for the power system is different from the recommended wiring, it is the customer's responsibility to ensure that all applicable electric codes for safety grounding requirements are met. As a precaution, always connect the screw marked  at the rear panel to proper earth ground.

## 2.5.2 SOURCE POWER CONNECTIONS

Source power is connected to the power supply via three-wire input power using the source power cable supplied (see Table 1-4). See Table 1-2 for source power specifications. This power supply operates from single phase a-c mains power (or between two phases of 3-phase a-c mains power) over the specified voltage and frequency ranges (Table 1-2) without any need for range selection.

**CAUTION: DO NOT USE AC SUPPLY WHICH EXCEEDS THE INPUT VOLTAGE AND FREQUENCY RATING OF THIS INSTRUMENT. THE INPUT VOLTAGE AND FREQUENCY RATING OF THE POWER SUPPLY ARE SHOWN IN TABLE 1-2. FOR SAFETY REASONS, THE MAINS SUPPLY VOLTAGE FLUCTUATIONS MUST NOT EXCEED  $\pm 10\%$  OF NOMINAL VOLTAGE.**

## 2.5.3 D-C OUTPUT GROUNDING

Connections between the power supply and the load and sensing connections may, despite all precautions such as shielding, twisting of wire pairs, etc., be influenced by radiated noise, or "noise pick-up". To minimize the effects of this radiated noise the user should consider grounding one side of the power supply/load circuit. The success of d-c grounding requires careful analysis of each specific application, however, this recommendation can only serve as a general guideline.

One of the most important considerations in establishing a successful grounding scheme is to avoid GROUND LOOPS. Ground loops are created when two or more points are grounded at different physical locations along the output circuit. Due to the interconnection impedance between the separated grounding points, a difference voltage and resultant current flow is superimposed on the load. The effect of this ground loop can be anything from an undesirable increase in output noise to disruption of power supply and/or load operation. The only way to avoid ground loops is to ensure that the entire output/load circuit is fully isolated from ground, and only then establish a single point along the output/load circuit as the single-wire ground point.

The exact location of the "best" d-c ground point is entirely dependent upon the specific application, and its selection requires a combination of analysis, good judgement and some amount of empirical testing. If there is a choice in selecting either the OUTPUT or COMMON output terminals of the power supply for the d-c ground point, both sides should be tried, and preference given to the ground point producing the least noise. For single, isolated loads the d-c ground point is often best located directly at one of the output terminals of the power supply; when remote error sensing is employed, d-c ground may be established at the point of sense lead attachment. In the specific case of an internally-grounded load, the d-c ground point is automatically established at the load.

The (+) and (–) terminals of KLN power supplies are d-c isolated ("floating") from the chassis in order to permit the user maximum flexibility in selecting the best single point ground location. Care must be taken in measuring the ripple and noise at the power supply: measuring devices which are a-c line operated can often introduce additional ripple and noise into the circuit.

There is, unfortunately, no "best" method for interconnecting the load and power supply. Individual applications, location and nature of the load require careful analysis in each case. Grounding a single point in the output circuit can be of great importance. It is hoped that the preceding paragraphs will be of some assistance in most cases. For help in special applications or difficult problems, consult directly with Kepco's Application Engineering Department.

## 2.5.4 POWER SUPPLY/LOAD INTERFACE

The general function of a voltage- or current-stabilized power supply is to deliver the rated output quantities to the connected load. The load may have any conceivable characteristic: it may be fixed or variable, it may have predominantly resistive, capacitive or inductive parameters; it may be located very close to the power supply output terminals or it may be a considerable distance away. The perfect interface between a power supply and its load would mean that the specified performance at the output terminals would be transferred without impairment to any load, regardless of electrical characteristics or proximity to each other.

The stabilized d-c power supply is definitely not an ideal voltage or current source, and practical interfaces definitely fall short of the ideal. All voltage-stabilized power supplies have a finite source impedance which increases with frequency, and all current-stabilized power supplies have a finite shunt impedance which decreases with frequency. The method of interface between the power supply output and the load must, therefore, take into account not only the size with regard to minimum voltage drop, but the configuration with regard to minimizing the impedance introduced by practical interconnection techniques (wire, bus bars, etc.). The series inductance of the load wire must be as small as possible as compared to the source inductance of the power supply: although the error sensing connection to the load compensates for the d-c voltage drop in the power leads, it cannot compensate for the undesirable output effects of the power lead inductance. These lead impedances (both power and sensing leads) are especially important if the load: is constantly modulated or step-programmed; has primarily reactive characteristics; or where the dynamic output response of the power supply is critical to load performance.

## 2.5.5 LOAD CONNECTION - GENERAL

Power connections to the load are achieved via the +POS and -NEG DC OUTPUT terminals located on the rear panel. Terminal connections for low voltage models (6V to 100V) are shown in Figure 2-9 (750W), 2-10 (1500W) or 2-11 (3000W). The 300V and 600V models employ Euro-block-style terminal blocks that accept bare wire ends.

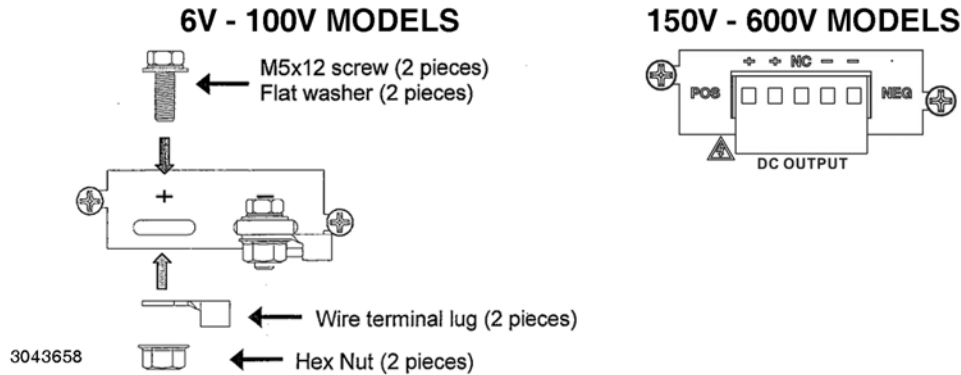
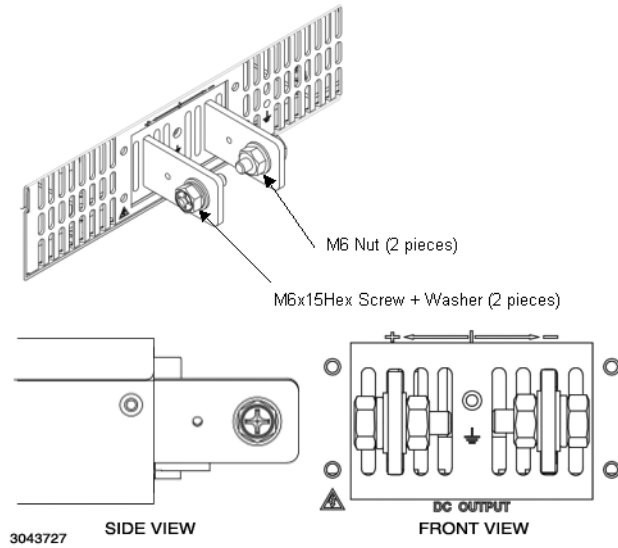

FIGURE 2-9. LOAD CONNECTION TERMINALS FOR 750W MODELS

**6V - 100V MODELS**

**150V - 600V MODELS**



**FIGURE 2-10. LOAD CONNECTION TERMINALS FOR 1500W MODELS**

**6V - 100V MODELS**

**150V - 600V MODELS**

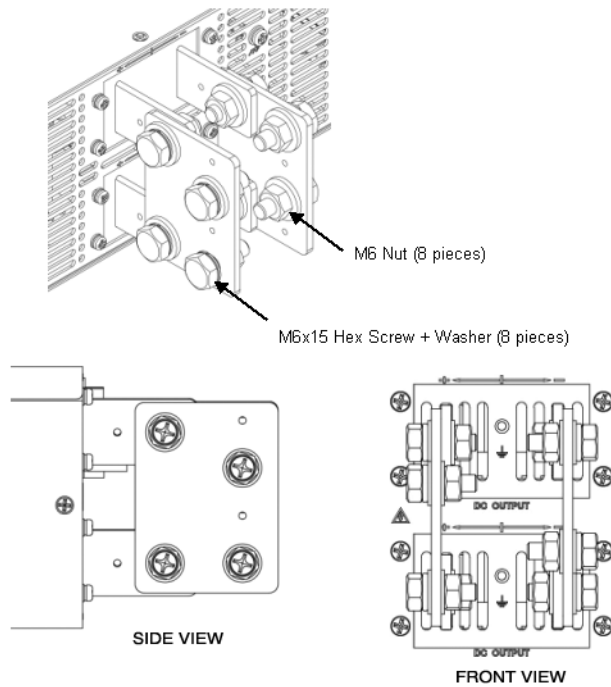

**FIGURE 2-11. LOAD CONNECTION TERMINALS FOR 3000W MODELS**

Kepeco strongly recommends the use of stranded (not solid) wire with (+) and (-) wires tightly twisted to reduce self-inductance; wire end ferrules are suggested to prevent fraying of the strands.

**NOTE** REGARDLESS OF OUTPUT CONFIGURATION, EITHER LOCAL OR REMOTE OUTPUT SENSE LINES SHOULD BE CONNECTED FOR OPTIMUM OPERATION.

- **OBSERVE POLARITIES:** The +S sensing wire must be connected to the (+) load wire, and the -S sensing wire must be connected to the (-) load wire.
- **IF LOCAL SENSING IS USED:** Install red and black sense leads supplied (see Figure 2-12).

### 2.5.6 LOAD CONNECTION USING LOCAL SENSING

Figure 2-12 shows a typical configuration using local sensing. Local sensing is recommended for a high noise or switching mode load such as d-c to d-c or d-c to a-c converter.

**CAUTION: CONNECT +S ONLY TO + AND -S ONLY TO -. CONNECTING +S TO -S, +V TO -S, OR -V TO +S WILL DAMAGE THE UNIT.**

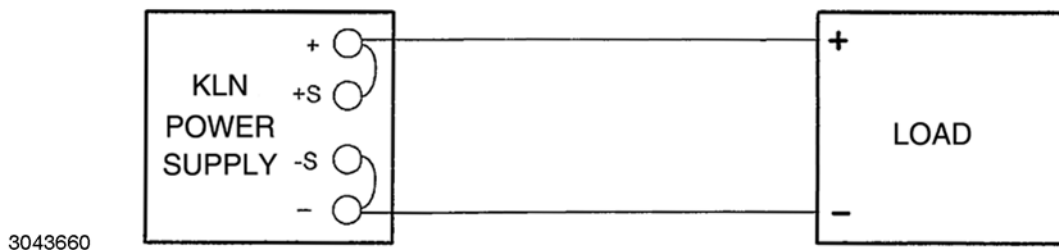

**FIGURE 2-12. LOAD CONNECTIONS, LOCAL SENSING**

Use the following formula and Figure 2-13 to calculate the voltage drop based on expected current and wire resistance. Refer to Table 2-5 for wire resistance for standard AWG sizes, as well as maximum recommended length of load wires for a voltage drop of less than 1V with expected load current of 5, 10, 20, 50 or 150 Amperes.

$$V_{\text{DROP}} = (I \times r1) + (I \times r2)$$

where r1 and r2 is the load wire resistance  
I is output current

$$\text{Voltage across Load } R_L = \text{Voltage (displayed on front panel display)} - V_{\text{DROP}}$$

3043659

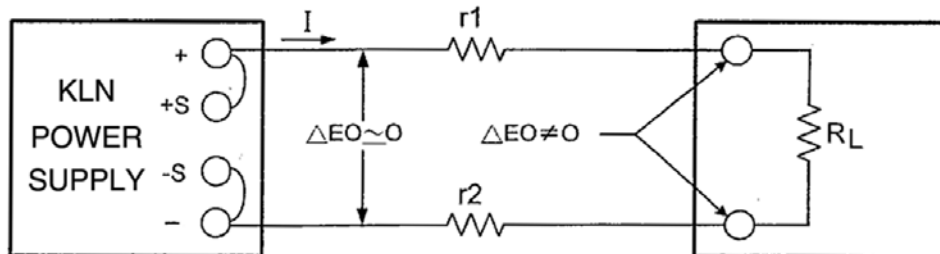

FIGURE 2-13. LOAD WIRE VOLTAGE DROP, EQUIVALENT SCHEMATIC DIAGRAM

TABLE 2-5. MAXIMUM LOAD WIRE LENGTH FOR VOLTAGE DROP LESS THAN 1V

AWG SIZE	Wire Diameter mm <sup>2</sup>	Resistance* (Ohm/100m)	Maximum Load Wire Length for Voltage drop less than 1V				
			Load Current 5A	Load Current 10A	Load Current 20A	Load Current 50A	Load Current 150A
14	2	0.8	24.4m	12.2m	6.1m	2.4m	0.6m
12	3.5	0.5	36.6m	18.3m	9.1m	3.7m	1.0m
10	5.5	0.3	61.0m	30.5m	15.2m	6.1m	1.8m
8	8	0.2	97.5m	48.8m	24.4m	9.8m	3.0m
6	14	0.1	152.4m	61.0m	38.1m	15.2m	4.9m
4	22	0.1	243.8m	121.9m	61.0m	24.4m	7.9m
2	38	0.1	365.7m	182.9m	91.4m	38.1m	12.2m
0	60	0.0	609.6m	304.8m	152.4m	61.0m	20.7m

\* Values shown are rounded up.

### 2.5.7 LOAD CONNECTION USING REMOTE SENSING

Figure 2-14 shows a typical configuration using remote sensing. Use #22 AWG wire, twisted pair for remote sense connections. Table 2-5 shows typical load wire length, AWG wire size and load current required for a voltage drop of less than 1V. Table 1-1 lists the maximum voltage drop compensation for each model that will allow voltage measured at the load to be the same as the voltage shown on the front panel display.

**CAUTION: CONNECT +S ONLY TO + AND -S ONLY TO -. CONNECTING +S TO -S, +V TO -S, OR -V TO +S WILL DAMAGE THE UNIT.**

3043661

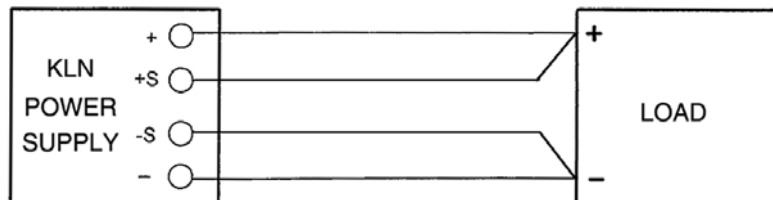

FIGURE 2-14. LOAD CONNECTIONS, REMOTE SENSING

## 2.6 COOLING

The power devices used within the power supply are maintained within their operating temperature range by means of internal heat sink assemblies and variable speed fans with air flow from front to back. There are no intake or exhaust ports at the top or bottom, permitting stacked rack mounting with no air gaps between stacked units. If the power supply is located within a confined space, take care that the ambient temperature, which is the temperature of the air immediately surrounding the power supply, does not rise above the specified limits (see Table 1-2).

## 2.7 SETTING UP THE UNIT

The following paragraphs describe the connections and initial KLN setup needed to operate in the desired mode.

### 2.7.1 SETUP FOR LOCAL OPERATION

After connecting the unit using either local (PAR. 2.5.6) or remote sensing (PAR. 2.5.7), the unit will power up in Local mode with no further setup required.

### 2.7.2 SETUP FOR REMOTE OPERATION VIA RS-485

**CAUTION: DO NOT CONNECT THE POSITIVE OUTPUT TO GROUND WHEN RS-485 IS USED. THERE IS A POTENTIAL SHOCK HAZARD AT THE RS-485 PORT WHEN POWER SUPPLIES ARE USED WITH RATED OR COMBINED VOLTAGE GREATER THAN 400V AND THE POSITIVE OUTPUT OF THE POWER SUPPLY IS GROUNDED.**

Connect the KLN to the controlling computer or to the previous unit in the RS-485 daisy chain per Figure 2-15. It is recommended that double shielded wire be used to ensure the quality of remote communication. The last unit on the RS-485 bus requires a 120-Ohm terminating resistor as shown in Figure 2-15.

With all power off, connect the load to the KLN using either local or remote sensing (refer to PAR. 2.5). If units are to be connected in series or parallel, refer to PAR. 2.8.

Turn power on and refer to PAR. 3.2 for power supply basics. See PAR. 3.3.16 to establish RS-485 baud rate and PAR. 3.3.18 to establish the RS-485 Address.

SCPI programming is described in PAR. 3.7; Appendices A and B provide syntax for SCPI common and subsystem commands and queries implemented in this unit. For RS-485 communication the RS-485 address (Axx x) must precede every command. E.g., to set the brightness to 3 and output voltage to 30 of a unit with RS-485 address 007, send

```
A007DISP:CONT 3;:A007SOUR:VOLT 30
```



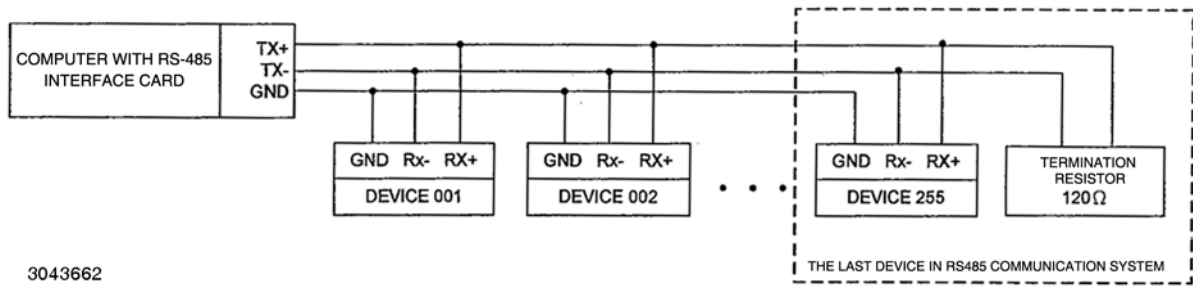

3043662

FIGURE 2-15. RS-485 CONNECTIONS

### 2.7.3 SETUP FOR REMOTE OPERATION VIA USB)

Operation via a USB port is possible using the RS-485 port of the KLN and a commercially available USB to RS-485 adapter, isolated (not supplied) as shown in Figure 2-16. See PAR. 2.7.2 and Figure 2-15 for RS-485 operation.

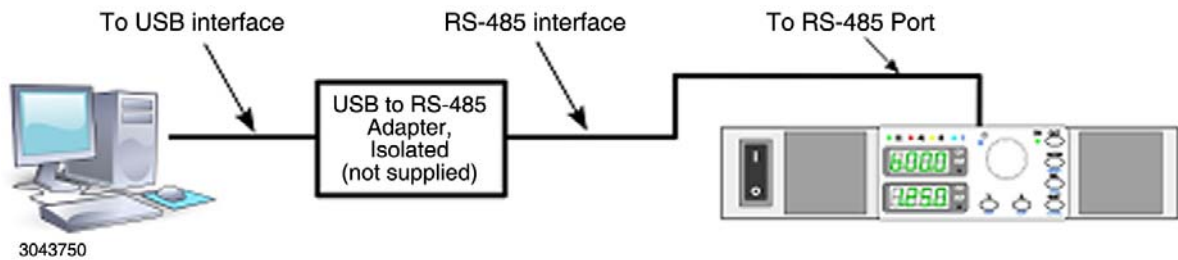

3043750

FIGURE 2-16. USB CONNECTIONS

### 2.7.4 SETUP FOR REMOTE OPERATION VIA GPIB (IEEE 488)

**CAUTION: DO NOT CONNECT THE POSITIVE OUTPUT TO GROUND WHEN IEEE 488 IS USED. THERE IS A POTENTIAL SHOCK HAZARD AT THE IEEE 488 (GPIB) PORT WHEN POWER SUPPLIES ARE USED WITH RATED OR COMBINED VOLTAGE GREATER THAN 400V AND THE POSITIVE OUTPUT OF THE POWER SUPPLY IS GROUNDED.**

Operation via GPIB is possible if the optional GPIB interface is installed. With all power off, connect the load to the KLN using either local or remote sensing. If units are to be connected in series or parallel, refer to PAR. 2.8. Connect the GPIB connector to a computer (ensure a proper GPIB interface card is installed in the computer) and the KLN GPIB port (see Figure 2-17). Turn power on and refer to PAR. 3.2 for power supply basics and PAR. 3.6 for digital remote mode programming. Verify GPIB communication using the utility software supplied by the manufacturer of the GPIB card installed in the computer.

Use I/O select (see PAR. 3.3.15) to select GPIB programming interface. The default GPIB address is 07; to change it refer to PAR 3.3.17. The unit automatically enters remote mode when a command is accepted.

SCPI programming is described in PAR. 3.7; Appendices A and B provide syntax for SCPI common and subsystem commands and queries implemented in this unit. All the features described for Local Mode operation can be accomplished using remote SCPI commands.

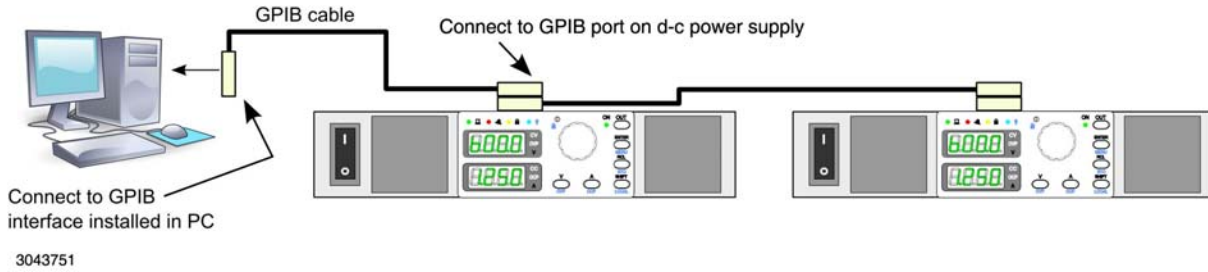

**FIGURE 2-17. GPIB CONNECTIONS**

### 2.7.5 SETUP FOR REMOTE OPERATION VIA LAN

Operation via LAN is possible if the optional LAN interface is installed.

Connect a computer to the LAN connector at the rear panel using a standard RJ 45 Ethernet cable, CAT 5 grade or higher (not supplied) per Figure 2-18. Use I/O Select (see PAR. 3.3.15) to select LAN programming interface. The unit automatically enters remote mode when a command is accepted. The LAN interface uses LAN Port 5025 for Telnet connections.

When connecting to the LAN with a DHCP server and DNS, the KLN will obtain an IP address automatically; this will take about one minute. The IP address information can be read from the front panel (see PAR. 3.3.21 through 3.3.36 and PAR. 3.3.45 through 3.3.47) or a web browser (see PAR 3.6.3).

See PAR. 3.6.3 to operate the unit via the LAN interface.

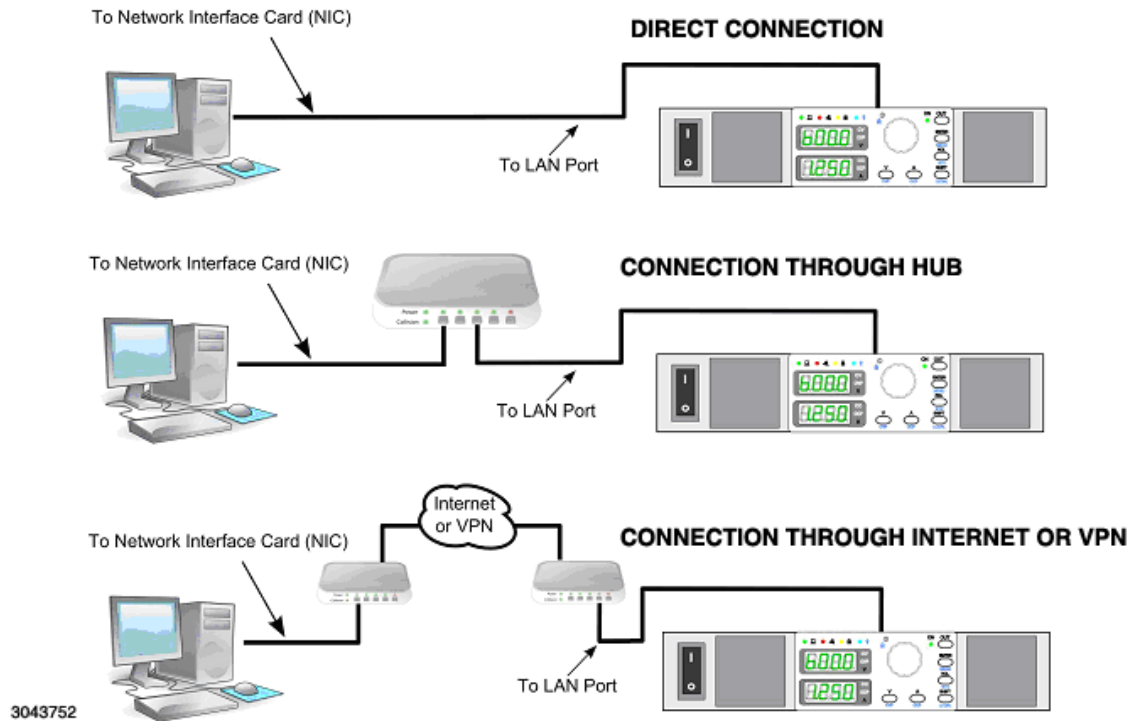

**FIGURE 2-18. LAN CONNECTIONS**

## 2.8 MULTIPLE UNIT CONFIGURATIONS

Parallel and series configurations of identical KLN units increase the rated current or voltage range of the power supply. Up to five units (including the master) can be connected in parallel to increase the current:  $I_{MAX} \text{ (one unit)} \times N_P = I_{MAX} \text{ (parallel combination)}$  where  $N_P$  = number of units in parallel. Similarly, up to two units (including the master) can be connected in series to increase the voltage:  $E_{MAX} \text{ (one unit)} \times N_2 = E_{MAX} \text{ (Series combination)}$  where  $N_2$  = number of units in series.

### 2.8.1 SERIES CONNECTIONS

Two identical KLN units (one master, one slave) can be operated in series to double the output voltage.

**CAUTION: TOTAL VOLTAGE MUST NOT EXCEED 600V TO AVOID DAMAGING THE UNITS.**

See Figure 2-19A for series connections with local sensing or Figure 2-19B for series connections with remote sensing. See PAR. 2.5.5 for guideline regarding load connections. See PAR. 3.4.1 for instructions on operating units connected in series.

Connections for series operation can be simplified by using the optional Series Connector Board (see Table 1-4) illustrated in Figures 2-19 and 2-20. If the optional Series Connector Board is not used, refer to Figure 2-21 for programming port connections required for series operation.

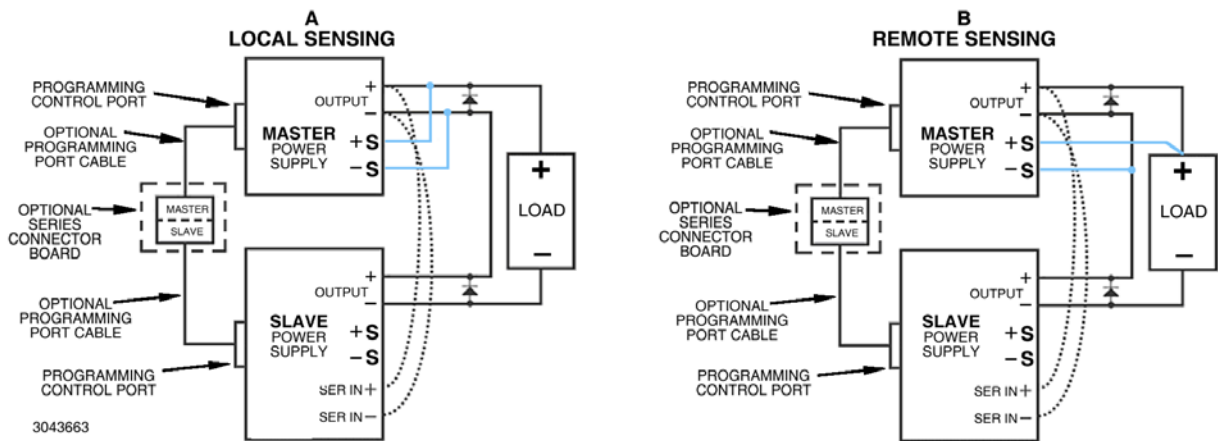
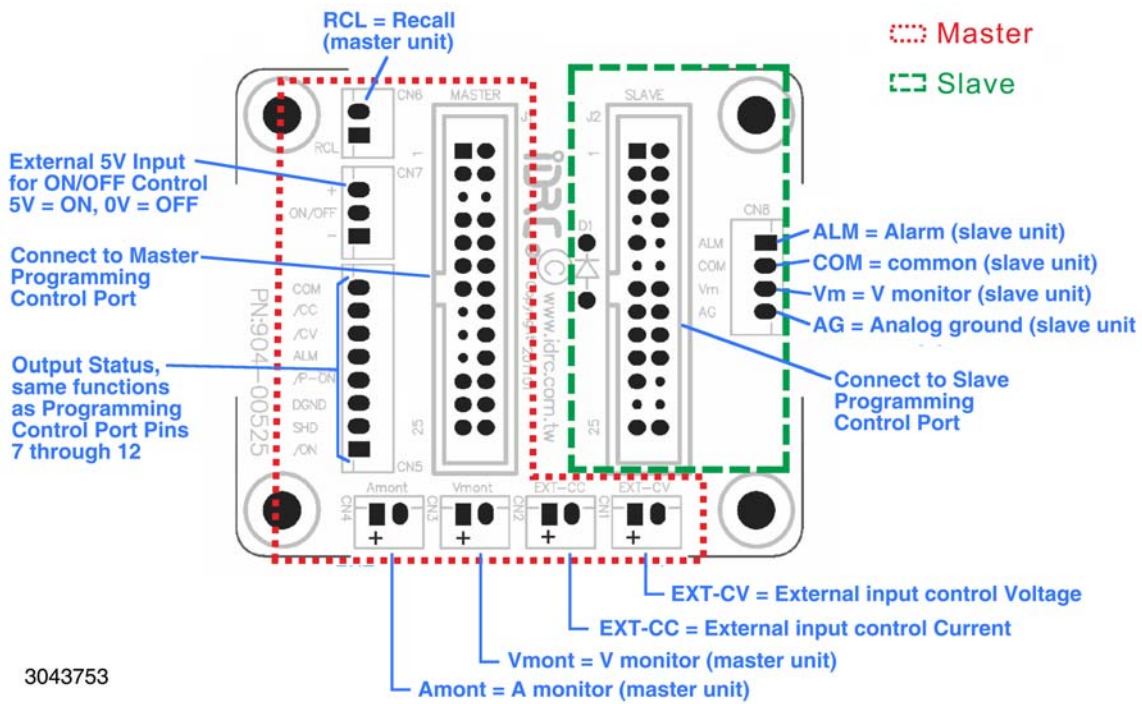

FIGURE 2-19. SERIES CONNECTIONS



3043753

FIGURE 2-20. OPTIONAL SERIES CONNECTOR BOARD

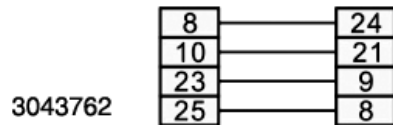

FIGURE 2-21. PROGRAMMING CONTROL PORT CONNECTIONS FOR SERIES OPERATION

## 2.8.2 PARALLEL CONNECTIONS

Up to five identical KLN units (one master and up to four slaves) can be operated in parallel to increase the output current. Output current of the parallel combination = number of units in parallel x output current of a single unit.

**CAUTION: OBSERVE CORRECT POLARITY FOR ALL CONNECTIONS.**

See Figure 2-22A for parallel connections with local sensing and Figure 2-22B for parallel connections with remote sensing. See PAR. 2.5.5 for guideline regarding load connections. See PAR. 3.4.3 for instructions on operating units connected in parallel.

Connections for parallel operation can be simplified by using the optional Parallel Connector Board (see Table 1-4) illustrated in Figures 2-22 and 2-23. When connecting two units in parallel, connections can be further simplified by using the optional Parallel Connection Cable, Kepco P/N 518-0121 which replaces the optional Parallel Connector Board and two Programming Port cables shown in Figure 2-22. If neither the optional Parallel Connector Board nor the Parallel Connection Cable are used, refer to Figure 2-24 for programming port connections required for parallel operation.

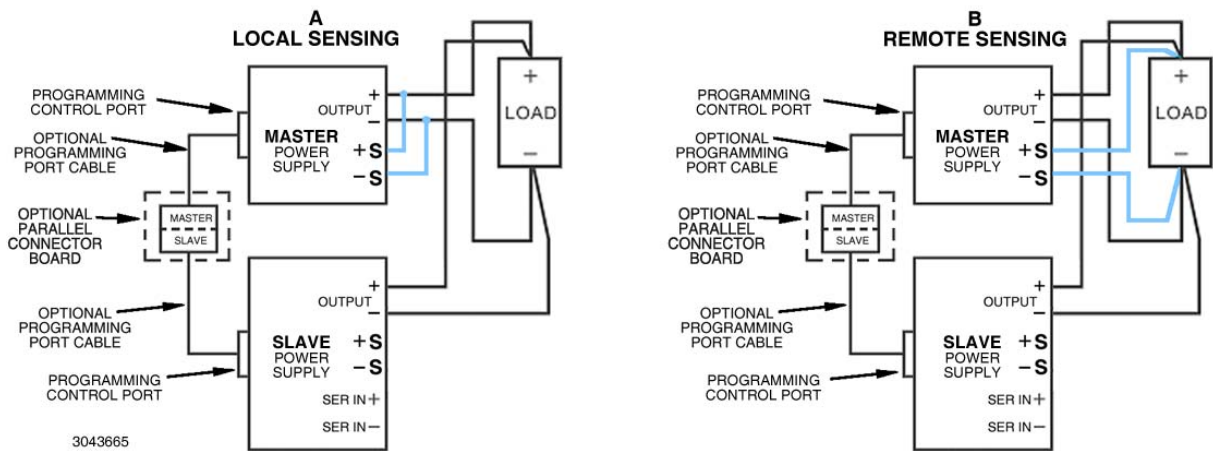

FIGURE 2-22. PARALLEL CONNECTIONS

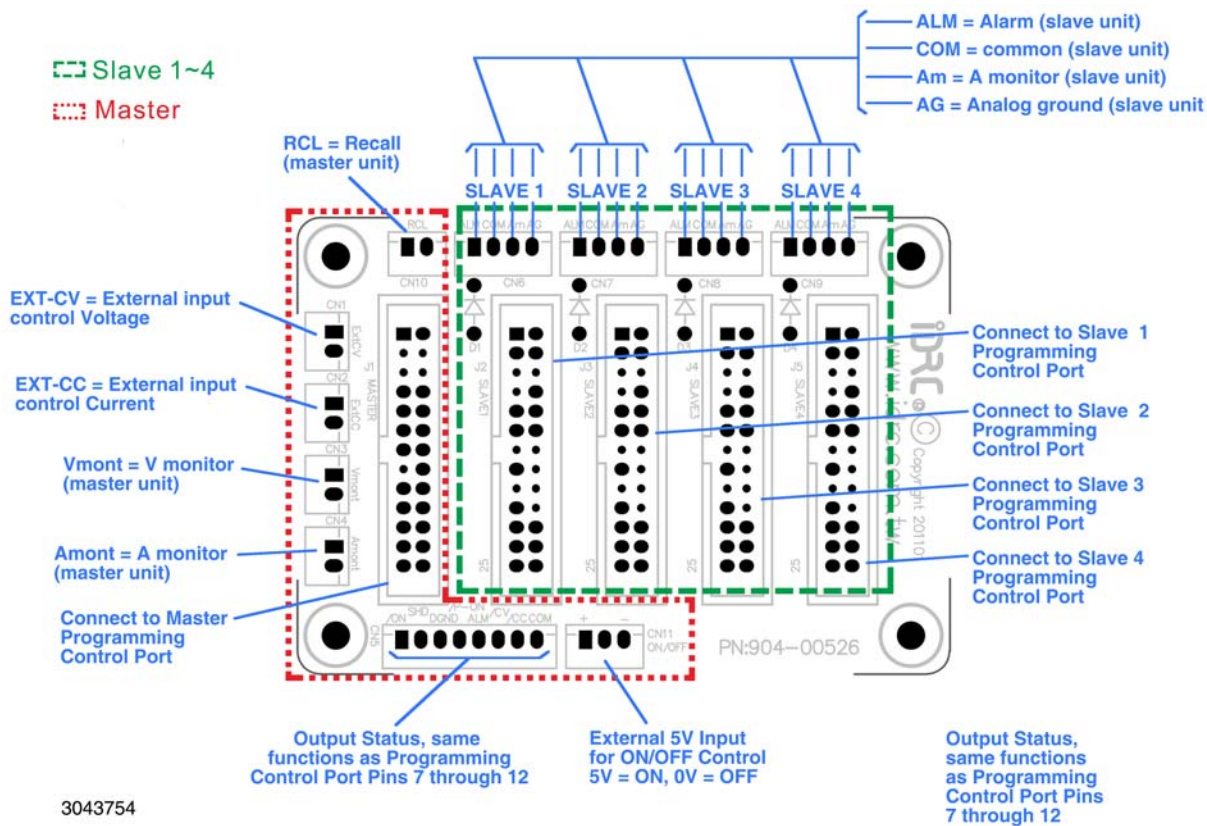

FIGURE 2-23. OPTIONAL PARALLEL CONNECTOR BOARD

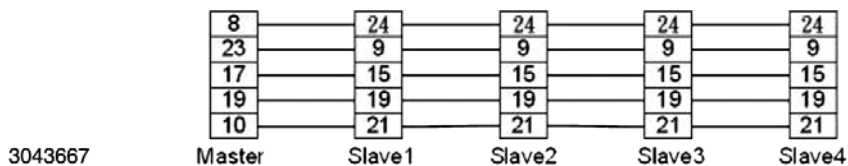

FIGURE 2-24. PROGRAMMING CONTROL PORT CONNECTIONS FOR PARALLEL OPERATION

## SECTION 3 - OPERATION

### 3.1 GENERAL

This section explains how to operate the KLN Power Supply. KLN Power Supplies feature three modes of operation:

- Local Mode (see PAR. 3.3): This is the default operating mode, providing full access to all programming and readback functions via front panel displays, controls, and indicators.
- Analog Remote Mode (see PAR. 3.5): The unit can be controlled using analog signals applied via the Programming Control port, regardless of whether local or digital remote is active.
- Digital Remote Mode (see PAR. 3.6): This mode is selected via commands transmitted through one of the digital ports. One port is for RS-485 port [standard models] The second port is optional: either an IEEE-488 (GPIB) (G-suffix models) port or a LAN port [E-Suffix models]. The port to be used must first be enabled using the Menu (see I/O Select, PAR. 3.3.15). The power supply automatically goes into digital remote mode when commands are accepted via one of the digital ports. All communication is via SCPI commands which afford full functionality of the KLN (see PAR. 3.7, Appendix A and Appendix B).

### 3.2 POWER SUPPLY BASICS

The following paragraphs describe basic operation of the front panel controls, which are used to configure and operate the power supply.

Refer to Table 3-1 and Figure 3-1 (750W), Figure 3-2 (1500W) or Figure 3-3 (3000W) for a description of front panel controls and indicators.

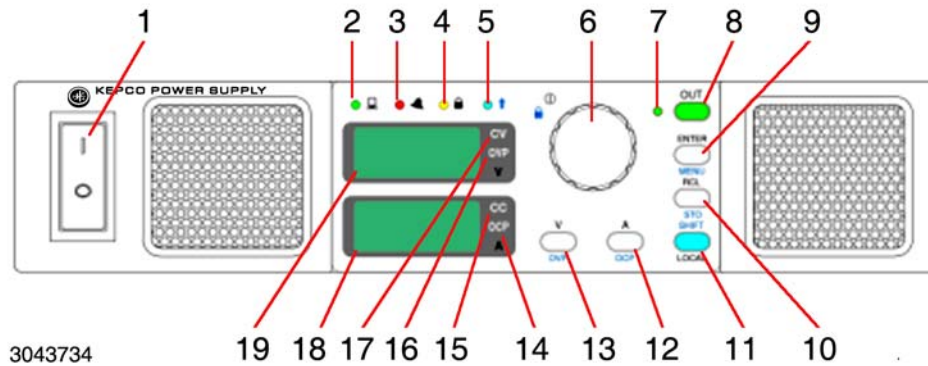

FIGURE 3-1. KLN 750W SERIES FRONT PANEL

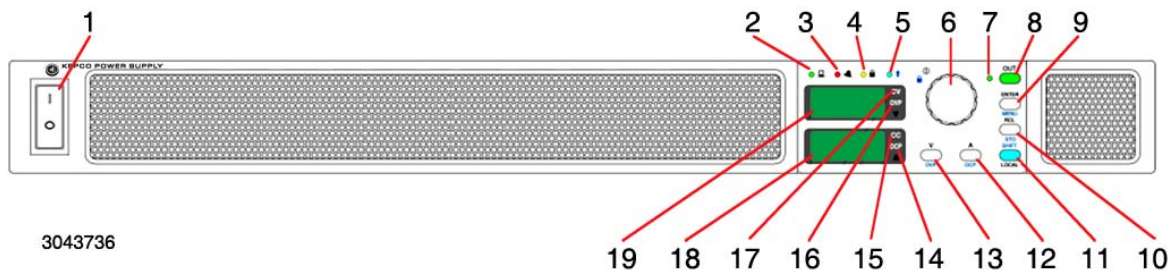

FIGURE 3-2. KLN 1500W SERIES FRONT PANEL

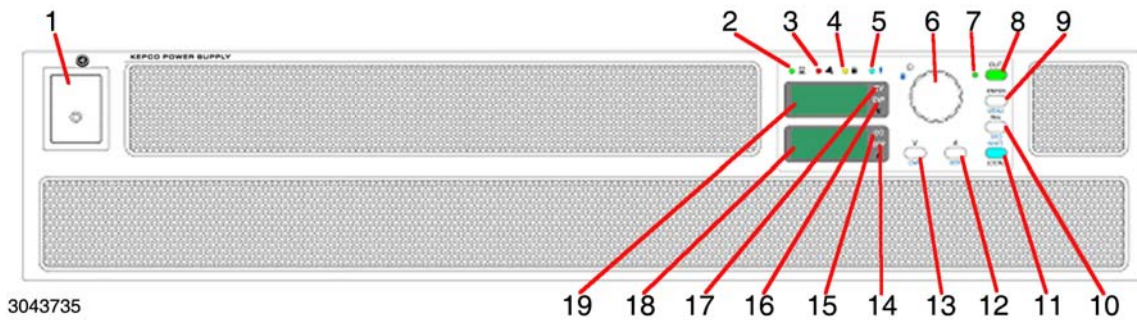







FIGURE 3-3. KLN 3000W SERIES FRONT PANEL

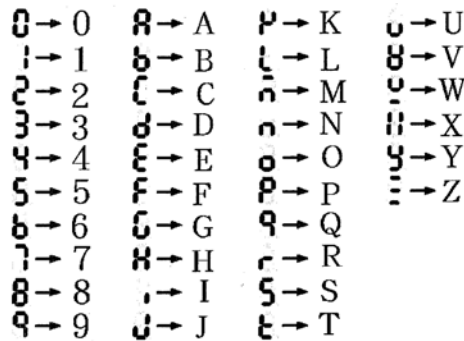

**TABLE 3-1. FRONT PANEL CONTROLS AND INDICATORS**

NUMBER (FIGURE 3-1)	CONTROL/INDICATOR	FUNCTION
1	POWER ON/OFF circuit breaker A7CB1	Applies source power to unit
2	 REMOTE status LED	Green LED, lights when unit is under remote control. Press <b>SHIFT</b> /LOCAL key to restore local control.
3	 ALARM status LED	Red LED, lights if a) OVP, OCP or OTP are triggered, b) command error, c) front panel operation error, d) emergency shutdown, or e) power supply failure. Refer to Table B-2 for an explanation of error codes.
4	 KEYLOCK status LED	Yellow LED, lights when front panel keys are locked. To lock the front panel keys and encoder, press SHIFT and tap the encoder. Repeat to unlock the front panel.
5	 SHIFT status LED	Blue LED, lights when SHIFT mode is active.
6	Encoder	The encoder Increases (clockwise) or decreases (counterclockwise) the highlighted digit of the Voltage or Current display, then press ENTER key to confirm. Tap the encoder to change the highlight. The highlighted digit blinks slowly.
7	Output ON/OFF status LED	Green LED, lights when output is on.
8	OUT on/off key	Output ON/OFF enable/disable. The DC power output will be set to OFF automatically in the following situations: a. Power on setting (PAR 3.3.9) is set to OFF and: 1) Restart of the AC input. (See PAR. 3.3.9 to configure whether unit powers up with out off at previous setting.) 2) The mains supply is interrupted for more than 100ms. 3) The mains supply exceeds or is under the rated input range more than 500ms. b. If OCP - OVP - OTP are detected.
9	ENTER/MENU dual function key	a. Press ENTER to confirm value set by encoder. b. Press SHIFT+ENTER to get access to MENU function. See PAR. 3.2.2 c. When output is ON, only limited Menu functions can be changed (see PAR. 3.3.5).
10	RCL/STO dual function key	A maximum of 16 memory settings can be stored or recalled. See PAR's. 3.3.6 and 3.3.7 for details. a. Press RCL as many times as needed to view the stored voltage/current settings in sequence, press ENTER to confirm recall, press V to exit recall function. b. Press SHIFT + STO to store settings. Rotate encoder to scroll through memory cells. Press ENTER to store programmed voltage and current settings, press ENTER to exit storage function.
11	SHIFT/LOCAL dual function key	When unit is operated manually in local mode, this key functions as a SHIFT key. When blue  LED is ON, the functions noted in blue text for the front panel keys can accessed when SHIFT is pressed. b. When the unit is remote controlled, only the LOCAL key is functional; press this key to exit remote control and restore local front panel operation.
12	A/OCP dual function key	a. Press <b>A/OCP</b> key to adjust the A set current value: the last digit of the Current display will be blinking. Turn the encoder to adjust the value of the blinking digit. Tap the encoder to go to the next digit. Press ENTER to confirm. A cannot be set more than programmed value of OCP. b. To set OCP press SHIFT key, then press <b>A/OCP</b> key. Use encoder and ENTER to set OCP. OCP cannot be set less than programmed value of A.
13	V/OVP dual function key	a. Press <b>V/OVP</b> key to adjust the V set voltage value: the last digit of the Voltage display will be blinking. Turn the encoder to adjust the value of the blinking digit. Tap the encoder to go to the next digit. Press ENTER to confirm. V cannot be set more than programmed value of OVP. b. To set OVP press SHIFT key, then press <b>V/OVP</b> key. Use encoder and ENTER to set OVP. OVP cannot be set less than programmed value of V.
14	OCP indicator	Overcurrent Protection indicator. Lights if overcurrent has occurred. Blinks while setting overcurrent protection.
15	CC indicator	Lights when unit is in Constant Current mode

**TABLE 3-1. FRONT PANEL CONTROLS AND INDICATORS (CONTINUED)**

NUMBER (FIGURE 3-1)	CONTROL/INDICATOR	FUNCTION
16	OVP indicator	Overvoltage Protection indicator. Lights if overvoltage error has occurred. Blinks while setting overvoltage protection value.
17	CV indicator	Lights when unit is in Constant Voltage mode
18	Current Display 4 digit LED	Displays output current or setting value in Amperes. CC indicator at right lights when unit is in constant current mode. OCP indicator lights if overcurrent error has occurred. OCP blinks while setting OCP value. Refer to Figure 3-4 to translate limited 7-segment display characters into standard alphanumeric characters.
19	Voltage Display 4 digit LED	Displays output voltage or setting value in Volts. CV indicator at right lights when unit is in constant voltage mode. OVP indicator lights if overvoltage error has occurred. OVP blinks while setting OVP value. Refer to Figure 3-4 to translate limited 7-segment display characters into standard alphanumeric characters.



**FIGURE 3-4. 7-SEGMENT DISPLAY CHARACTERS**

### 3.2.1 TURNING THE POWER SUPPLY ON

1. To turn the power supply on, set **POWER ON/OFF** circuit breaker (1, Figure 2-1) to ON. Apply firm, continuous pressure to rocker actuator until fully engaged.
2. When the power supply is turned on, it beeps and performs a self-test which sequentially checks the power status, PFC module (DC bus voltage), A/D converter, display board, SENSE status, and EEPROM.
3. While the self-test is in process, the following occurs:
  - For 1 second all the indicators on the front panel are lit.
  - For 1.6 seconds the Voltage display shows rated voltage and the Current display shows rated current. The rest of the indicators are unlit and the digital and analog interfaces are temporarily disabled.
  - For 1.2 seconds the Voltage display shows Hx.xx (hardware version) and the Current display shows Fx.xx (firmware version). The rest of the indicators are still unlit.
  - For 1.2 seconds the Voltage display shows Ax.xx (Main Control version) and Current display shows Dx.xx (display board version). The rest of the indicators are still unlit.
4. When the self-test is complete, the Voltage display shows the last voltage setpoint value and the Current display shows the last current setpoint value. All the front panel keys are functional and the remote-controlled functions can be enabled.

- If an error occurs, the red  (alarm) LED goes on. Refer to PAR. 3.3.50 to view the error code.

5. When the unit is turned on for the first time, the factory default conditions upon power up after a successful self test are as shown in Table 3-2.

**TABLE 3-2. FACTORY DEFAULTS**

Parameter	Factory Default
Output V	10% of rated voltage (0V for E- or G- suffix models)
Output C	10% of rated current (0A for E- or G- suffix models)
OVP	110% of rated Voltage
OCP	110% of rated Current
Output: On/off	OFF
Power On: LAST/OFF	OFF
RAMP UP time	0.1
RAMP down time	0
Undervoltage Limit	0
BEEP: On/Off	On
I/O Select	RS 485
RS 485 Baud rate	115200
GPIB address	07
RS 485 address	007
Parallel/Series: PM/PS/SM/SS	PM
External Control of output: ON/OFF	OFF
Voltage Control: LOC/EXT	LOC
Current Control: LOC/EXT	LOC
Front panel lockout	OFF
Voltage Set: Direct/Enter	Direct
DHCP: On/Off	On
SYST:COMM:LAN:GATE	DHCP On: from DHCP server DHCP Off: 0.0.0.0
SYST:COMM:LAN:IP	DHCP On: From DHCP server DHCP Off: 192.168.0.100
SYST:COMM:LAN:IPAD	192.168.0.100
SYST:COMM:LAN:SMAS	255.255.255.0
SYST:COMM:LAN:MAC	70-46-42-XX-XX-XX
SYST:COMM:LAN:TEL:PORT	5025

**NOTES:**

- (1) Parameters changed via front panel are saved when unit is powered off, and will be restored upon power-up. Parameters changed via SCPI command are not saved when unit is turned off and are restored to the last value entered from front panel when power is cycled on.
- (2) \*RST resets the following: Output to OFF, Output V to 0V, Output A to 0A, OVP to 110% of rated voltage, OCP to 110% of rated current, Undervoltage Limit to 0, and front panel lockout to OFF. All other parameters shown above are restored to the last value entered from front panel.
- (3) Cycling power resets the following: Output to setting determined by Power On setting (see PAR. 3.3.9), Undervoltage Limit to 0 and front panel lockout to OFF. All other parameters shown above are restored to the last value entered from front panel.
- (4) RST1 resets the IP address to 192.168.0.100/255.255.0.0 and clears the Gateway and DNS settings.
- (5) Parameters for options are defined only when applicable (see Table 3-3).

### 3.2.2 MENU STRUCTURE

Many of the KLN functions are accessed via MENU mode (see Table 3-3 for complete list of MENU functions).

1. Press SHIFT key to enter SHIFT mode. Verify blue  LED lights, then press ENTER key to enter MENU mode.

NOTE: Only limited Menu functions can be changed if the output is set to ON (see PAR. 3.3.5).

2. Rotate encoder to select MENU functions. Functions are displayed in the order shown in Table 3-3. Menu functions are shown in the Voltage display and the corresponding value of the function is shown in the Current display.
3. When the desired MENU function is shown in the Voltage display, press ENTER key to access the selected function and setting.
4. To change the digit tap the encoder. The highlighted digit can be changed by rotating the encoder. Tap the encoder to move to the next digit. When the setting is complete press ENTER key to confirm.
5. Rotate encoder to move to the next MENU function.
6. Press SHIFT key to enter SHIFT mode. Verify blue  LED lights, then press ENTER key to leave MENU mode.

### 3.3 LOCAL MODE OPERATION

Local operation of the KLN power supply is accomplished from the front panel via the front panel keys and the encoder. All indications are provided by the two 4-digit LED displays, each with two integral status indicators, and five front panel status LEDs.

#### 3.3.1 SETTING LOCAL/REMOTE MODE

When the power supply is turned on, it is automatically set to Local mode. If digital remote mode is active, the (REMOTE  indicator is lit) the unit can be restored to local mode by pressing the SHIFT/LOCAL (LOCAL) key on the front panel.

NOTE: It is recommended that the unit be reset (see PAR. 3.3.48) when changing from digital remote to local control to avoid conflicts with digital commands.

After the desired port (GPIB, RS-485, or LAN) has been selected (see PAR. 3.3.15), the power supply will automatically go into digital remote mode when digital remote commands are accepted. Analog remote control signals via the Programming Control port (see Table 2-4) are available when enabled (see PAR. 3.3.39 for voltage control, PAR. 3.3.40 for current control). Analog status signals from the Programming Control port are always available.

**TABLE 3-3. MENU FUNCTIONS**

Voltage Display	Current Display	Description	Reference
ERR	000 ~ 999	Error Code	PAR. 3.3.50
OUT	DIR or ENT	Output Mode Setting	PAR. 3.3.8
P.ON	LAST or OFF	Power ON Mode	PAR. 3.3.9
R.UPT	00.0 ~99.9	Ramp Up Time	PAR. 3.3.10
R.DNT	00.0 ~99.9	Ramp Down Time	PAR. 3.3.11
MEM.F	01 ~ 16	Memory Flag	PAR. 3.3.12
BEEP	ON or OFF	Key Beep On/Off	PAR. 3.3.13
BRIT	0 ~ 5	Display Brightness	PAR. 3.3.14
I.O	485 or GPIB <sup>(1)</sup> or LAN <sup>(2)</sup>	Interface Select	PAR. 3.3.15
485	4.8K, 9.6K, 19.2K, 38.4K, 57.6K, 115.2K	RS-485 baud rate	PAR. 3.3.16
GPIB <sup>(1)</sup>	00 ~ 30	GPIB Address	PAR. 3.3.17
485	A001 ~ A254	RS-485 Address	PAR. 3.3.18
DHCP <sup>(2)</sup>	OFF or ON	DHCP function	PAR. 3.3.19
DNS	OFF or ON	DNS function	PAR. 3.3.20
S.IP1/V.IP1 <sup>(2)</sup>	001 ~ 223	Set (if DHCP is OFF) or view (if DHCP is ON) part 1 of IP Address	PAR. 3.3.21
S.IP2/V.IP2 <sup>(2)</sup>	001 ~ 254	Set (if DHCP is OFF) or view (if DHCP is ON) part 2 of IP Address	PAR. 3.3.22
S.IP3/V.IP3 <sup>(2)</sup>	001 ~ 254	Set (if DHCP is OFF) or view (if DHCP is ON) third IP part of Address	PAR. 3.3.23
S.IP4/V.IP4 <sup>(2)</sup>	001 ~ 254	Set (if DHCP is OFF) or view (if DHCP is ON) fourth IP part of Address	PAR. 3.3.24
S.MN1/V.MN1 <sup>(2)</sup>	000 ~ 255	Set (if DHCP is OFF) or view (if DHCP is ON) part 1 of Subnet Address	PAR. 3.3.25
S.MN2/V.MN2 <sup>(2)</sup>	000 ~ 255	Set (if DHCP is OFF) or view (if DHCP is ON) part 2 of Subnet Address	PAR. 3.3.26
S.MN3/V.MN3 <sup>(2)</sup>	000 ~ 255	Set (if DHCP is OFF) or view (if DHCP is ON) part 3 of Subnet Address	PAR. 3.3.27
S.MN4/V.MN4 <sup>(2)</sup>	000 ~ 255	Set (if DHCP is OFF) or view (if DHCP is ON) part 4 of Subnet Address	PAR. 3.3.28
S.GW1/V.GW1 <sup>(2)</sup>	001 ~ 223	Set (if DHCP is OFF) or view (if DHCP is ON) part 1 of Gateway Address	PAR. 3.3.29
S.GW2/V.GW2 <sup>(2)</sup>	001 ~ 254	Set (if DHCP is OFF) or view (if DHCP is ON) part 2 of Gateway Address	PAR. 3.3.30
S.GW3/V.GW3 <sup>(2)</sup>	001 ~ 254	Set (if DHCP is OFF) or view (if DHCP is ON) part 3 of Gateway Address	PAR. 3.3.31
S.GW4/V.GW4 <sup>(2)</sup>	001 ~ 254	Set (if DHCP is OFF) or view (if DHCP is ON) part 4 of Gateway Address	PAR. 3.3.32
S.DN1/V.DN1 <sup>(2)</sup>	001 ~ 223	Set (if DNS is OFF) or view (if DNS is ON) part 1 of DNS Address	PAR. 3.3.33
S.DN2/V.DN2 <sup>(2)</sup>	001 ~ 254	Set (if DNS is OFF) or view (if DNS is ON) part 2 of DNS Address	PAR. 3.3.34
S.DN3/V.DN3 <sup>(2)</sup>	001 ~ 254	Set (if DNS is OFF) or view (if DNS is ON) part 3 of DNS Address	PAR. 3.3.35
S.DN4/V.DN4 <sup>(2)</sup>	001 ~ 254	Set (if DNS is OFF) or view (if DNS is ON) part 4 of DNS Address	PAR. 3.3.36
PSOP	PM, PS, SM or SS	Parallel Master, Parallel Slave, Series Master, Series Slave	PAR. 3.3.37
EO.C	OFF or ON	External On/Off control enable/disable	PAR. 3.3.38
CV.M	LOC or EXT	Voltage set, either LOC (Local) using the front panel or EXT (External) using the analog signal from the Programming Control port.	PAR. 3.3.39

(1) Only if optional GPIB interface installed.      (2) Only if optional LAN interface installed.



**TABLE 3-3. MENU FUNCTIONS**

Voltage Display	Current Display	Description	Reference
CC.M	LOC or EXT	Current set, either LOC (Local) using the front panel or EXT (External) using the analog signal from the Programming Control port.	PAR. 3.3.40
CAL	0000	Calibration password.	PAR. 3.3.41
SNnn	nnnn	Serial Number, where nnnnnn = 6 numbers, two numbers in Voltage Display, four numbers in Current display.	PAR. 3.3.42
FW	x.xx	Firmware version where xx.x = numbers (cannot be modified)	PAR. 3.3.43
HW	y.yy	Hardware version where y.yy = numbers.	PAR. 3.3.44
V.MA1 <sup>(2)</sup>	70.46	View part 1 of MAC Address	PAR. 3.3.45
V.MA2 <sup>(2)</sup>	42.xx	View part 2 of MAC Address	PAR. 3.3.46
V.MA3 <sup>(2)</sup>	xx.xx	View part 3 of MAC Address	PAR. 3.3.47
RST	OFF or ON	Reset Function.	PAR. 3.3.48
RSTI <sup>(2)</sup>	OFF or ON	IP Address Reset Function.	PAR. 3.3.49

(1) Only if optional GPIB interface installed. (2) Only if optional LAN interface installed.

### 3.3.1.1 FRONT PANEL LOCKOUT

To prevent unauthorized setting of the power supply, KEYLOCK can be enabled which disables the front panel keys and the encoder.

Press SHIFT key to enter SHIFT mode (  LED lit), then tap the encoder to enable KEYLOCK. The yellow  indicator goes on and all the front panel keys (except SHIFT) and the encoder are disabled.

To exit KEYLOCK tap the encoder while in SHIFT mode (  LED lit).

### 3.3.2 SET VOLTAGE OR OVERVOLTAGE PROTECTION (OVP)

The maximum setting for voltage is 105% of rated voltage and cannot be adjusted to exceed the OVP setting. The maximum setting for OVP is 110% of rated voltage and cannot be set to less than the programmed value of V. See PAR. B.32 and B.36 for SCPI commands.

1. Verify Output Mode set to ENTER (see PAR. 3.3.8)
2. To set voltage, press **V/OVP** (V set) key. To set OVP, first press SHIFT key (blue  LED goes on), then press **V/OVP** key.
3. The right-most digit blinks. Rotate the encoder to change the value. Tap the encoder to go to the next digit. When adjustment is complete, press ENTER to confirm.

### 3.3.3 SET CURRENT OR OVERCURRENT PROTECTION (OCP)

The maximum setting for current is 105% of rated current and cannot be adjusted to exceed the OCP setting. The maximum setting for OCP is 110% of rated current and cannot be set to less than the programmed value of A. See PAR. B.14 and B.16 for SCPI commands.

1. Verify Output Mode set to ENTER (see PAR. 3.3.8)
2. To set current, press **A/OCP** (A set) key. To set OCP, first press SHIFT key (blue  LED goes on), then press **A/OCP** key.
3. The right-most digit blinks. Rotate the encoder to change the value. Tap the encoder to go to the next digit. When adjustment is complete, press ENTER to confirm.

### 3.3.4 OVP/OVC OPERATION AND RECOVERY

If the unit detects an overvoltage or overcurrent condition, the OVP or OCP indicator and the red ALARM indicator on the front panel light, the unit starts beeping and the output is set to OFF (output voltage and current are zero). To recover, recycle power by turning the unit off then on: the unit powers up with output off, no beeps and OVP/OVC indicator not lit. Before turning the output ON, either 1) programmed voltage or current must be reduced, or 2) OVP or OCP setting must be increased; otherwise the unit will again detect OVP or OVC condition resulting in output OFF, unit beeping and OVP or OVC indicator lit. Note that OVP and OCP can not be set to less than the programmed value for voltage and current respectively, and voltage and current can not be programmed to be higher than the OVP and OCP setpoint, respectively.

**CAUTION:** The unit may detect OVP or OCP if voltage/current is programmed very close to the OVP/OCP limits. For this case, changing the settings as outlined above is acceptable. However, detection of OVP/OCP normally indicates a malfunction, either in the load, or in the KLN power supply itself, therefore the cause of the malfunction should be determined before setting the output to ON.

### 3.3.5 ENABLING/DISABLING DC OUTPUT POWER

To enable the output press the OUT key on the front panel. The green LED (7, Figure 3-1) adjacent to the OUT key goes on to indicate the output is enabled.

If the output is enabled, press the OUT key to disable the output (the green LED goes out).

When the output is ON, only the following parameters can be changed via the front panel menu: Output mode set (PAR. 3.3.8), Power ON mode (PAR. 3.3.9), Ramp up/down time (PAR. 3.3.10, 3.3.11), RCL start/end settings (PAR 3.3.7), display brightness (PAR 3.3.14), audible beep (PAR 3.3.13), interface selection (PAR 3.3.15), and RS 485 baud rate (PAR 3.3.16), address (PAR 3.3.18) and erasing viewed error codes (PAR 3.3.50).

### 3.3.6 STORING POWER SUPPLY OUTPUT SETTINGS

Up to 16 memory locations can be used to store power supply settings for later use. The only settings saved are V set and A set. Protection (OVP and OCP) values are not saved.

1. Program voltage (PAR. 3.3.2) and current (PAR. 3.3.3) settings to be stored.
2. Press SHIFT key to enter SHIFT mode (blue  indicator goes on), then press RCL/STO key to access storage function. The voltage display shows 01.
3. Rotate the encoder to change the number of the storage location. This number can not exceed the value set for Memory Flag (see PAR. 3.3.12).
4. When the desired memory location is showing in the Voltage display, press ENTER key to store setting programmed in step 1. Settings previously saved in that location will be overwritten.
5. Press ENTER to exit storage function.

### 3.3.7 RECALLING POWER SUPPLY OUTPUT SETTINGS

To recall the setting previously stored in one of 16 memory locations (see PAR. 3.3.6) proceed as follows. When settings are recalled they can not exceed the OVP/OCP values in effect at the time of recall. Power supply settings can also be recalled using the Programming Control port (see PAR. 3.5.5).



#### CAUTION:

- Before applying recalled settings to a load, verify that the OVP and OCP settings are correct. OVP and OCP do not change automatically.
  - If the output is on when **RCL/STO** key is pressed, the Voltage and Current displays show the recalled settings and blink for three seconds.
  - If the output is off when **RCL/STO** key is pressed, the Voltage and Current displays show the recalled settings and blink until **V/OVP** key is pressed
1. Press **RCL/STO** key to access recall function. The voltage and current displays blink and show the contents of memory location 01. (If the output is ON, the blinking stops after three seconds.)
  2. Press **RCL/STO** key to scroll through remaining memory locations with stored settings. Only those memory locations that have stored settings are displayed (see PAR. 3.3.12).
  3. When the voltage and current displays show the desired settings to recall. Press **V/OVP** key to exit recall function.

### 3.3.8 OUTPUT MODE (VOLTAGE SET: DIRECT OR ENTER)

There are two ways to program output voltage: DIRECT or ENTER. When output mode is set to DIRECT, rotating the encoder with the output set to ON changes the output immediately as the encoder is turned. When set to ENTER, the settings are not applied to the output until confirmed by pressing ENTER.

1. Enter the menu (see PAR. 3.2.2 and Table 3-3) and rotate the encoder until Voltage display shows  (OUT) to access OUTPUT mode.

2. Press ENTER key to view setting.

DIRECT mode displayed as  (DIR) in Current display.

ENTER mode displayed as  (ENT) in Current display.

3. Rotate encoder until Current display shows desired setting, then press ENTER to confirm.



### 3.3.9 POWER ON SETTING

When the unit is powered on or recovering from a loss of mains supply, the output can be configured to restart with output status LAST or OFF. When set to LAST, output status is restored to the last output status (ON or OFF) before the unit was turned off. When set to OFF, the output status will always be off upon power supply restart.

1. Enter the menu (see PAR. 3.2.2 and Table 3-3) and rotate the encoder until Voltage display shows  (P.ON) to access POWER ON setting.

2. Press ENTER key to view setting.

LAST mode displayed as  (LAST) in Current display.

OFF mode displayed as  (OFF) in Current display.

3. Rotate encoder until Current display shows desired setting, then press ENTER to confirm.

### 3.3.10 RISE TIME (RAMP UP)

When the output is enabled, the time for the output to go from 0 to the programmed voltage is referred to as the ramp up (rise) time, and is adjustable from 00.0 to 99.9 seconds. The time setting affects the slope of the increase in output voltage: it is added to the response time for “full load up” given in Table 1-1.

1. Enter the menu (see PAR. 3.2.2 and Table 3-3) and rotate the encoder until Voltage display shows  (R.UPT) to access RAMP UP setting.

2. Press ENTER key to view setting.

Ramp up time displayed as  (0.01) in Current display.

3. Rotate encoder until Current display shows desired setting, then press ENTER to confirm.

### 3.3.11 FALL TIME (RAMP DOWN)

When the output is disabled, the time for the output to go from the programmed voltage to 0 is referred to as the ramp down (fall) time, and is adjustable from 00.0 to 99.9 seconds. The time setting affects the slope of the decrease in output voltage: it is added to the response time for “full load down” given in Table 1-1. This function is disabled when set to 0.

1. Enter the menu (see PAR. 3.2.2 and Table 3-3) and rotate the encoder until Voltage display shows  (R.DNT) to access RAMP DOWN setting.

2. Press ENTER key to view setting.

Ramp down time displayed as  (0.00) in Current display.

3. Rotate encoder until Current display shows desired setting, then press ENTER to confirm.

### 3.3.12 MEMORY FLAG

There are 16 memory locations that can be used to store and recall power supply settings. MEM.F is used to limit the range of locations that can be accessed. For example, when the MEMORY FLAG is set as 05, it means that RECALL can only be executed from memory locations 01 through 05.

1. Enter the menu (see PAR. 3.2.2 and Table 3-3) and rotate the encoder until Voltage display shows  (MEM.F) to access MEMORY FLAG setting.

2. Press ENTER key to view setting.

Memory flag displayed as  (01) in Current display.

3. Rotate encoder until Current display shows desired setting, then press ENTER to confirm.

### 3.3.13 BEEP

The BEEP function enables or disables the audible beep each time a front panel key is pressed.

1. Enter the menu (see PAR. 3.2.2 and Table 3-3) and rotate the encoder until Voltage display shows  (BEEP) to access BEEP function.

2. Press ENTER key to view setting.

Beep ON (default) displayed as  (ON) in Current display.

Beep OFF displayed as  (OFF) in Current display.

3. Rotate encoder until Current display shows desired setting, then press ENTER to confirm.

### 3.3.14 DISPLAY BRIGHTNESS

The brightness level for the Voltage and Current displays can be set from 0 (dimpest) to 5 (brightest).

1. Enter the menu (see PAR. 3.2.2 and Table 3-3) and rotate the encoder until Voltage display shows  (BRIT) to access BRIGHTNESS setting.

2. Press ENTER key to view setting

Brightness level (0, 1, 2, 3, 4 or 5) displayed in Current display, e.g.,  (3).

3. Rotate encoder until Current display shows desired setting, then press ENTER to confirm.

### 3.3.15 I/O SELECT

Used to select either RS-485 (standard) or optional GPIB or LAN interfaces for remote digital control.

1. Enter the menu (see PAR. 3.2.2 and Table 3-3) and rotate the encoder until Voltage display shows  (I.O) to access I/O SELECT setting.

2. Press ENTER key to view setting.

RS-485 mode displayed as  (485) in Current display.

GPIB mode displayed as  (GPIB) in Current display if GPIB interface installed.

LAN mode displayed as  (LAN) in Current display if LAN interface installed.

3. Rotate encoder until Current display shows desired setting, then press ENTER to confirm.

### 3.3.16 RS-485 BAUD RATE

Used to select baud rate for RS-485 communication. Default setting is 115K

1. Enter the menu (see PAR. 3.2.2 and Table 3-3) and rotate the encoder until Voltage display shows  (485) to access RS-485 BAUD RATE setting.

2. Press ENTER key to view setting.

4800 baud rate displayed as  (4.8K) in Current display.

9600 baud rate displayed as  (9.6K) in Current display.

19200 baud rate displayed as  (19.2K) in Current display.

38400 baud rate displayed as  (38.4K) in Current display.

57600 baud rate displayed as  (57.6K) in Current display.

115200 baud rate displayed as  (115K) in Current display.

3. Rotate encoder until Current display shows desired setting, then press ENTER to confirm.

### 3.3.17 GPIB ADDRESS (GPIB INTERFACE ONLY)

Used to set the GPIB address. Available addresses from 00 to 30. Default GPIB address is 07.

1. Enter the menu (see PAR. 3.2.2 and Table 3-3) and rotate the encoder until Voltage display shows  (GPIB) to access GPIB ADDRESS setting.



2. Press ENTER key to view setting.

GPIB address (default) displayed as  (07) in Current display.

3. Rotate encoder until Current display shows desired setting, then press ENTER to confirm.

### 3.3.18 RS-485 ADDRESS

Used to set the RS-485 address. Available addresses from A001 to A254. Default RS-485 address is A007.

1. Enter the menu (see PAR. 3.2.2 and Table 3-3) and rotate the encoder until Voltage display shows  (485), then  (GPIB) if GPIB option is installed, then  (485) to access RS-485 ADDRESS setting.

2. Press ENTER key to view setting.

RS-485 address (default) displayed as  (A007) in Current display.

3. Rotate encoder until Current display shows desired setting, then press ENTER to confirm.

### 3.3.19 DHCP FUNCTION ON/OFF CONTROL (LAN INTERFACE ONLY)

Used to allow the IP address to be assigned from the DHCP server when set to ON. If DHCP is set to ON, the current IP address is set by the DHCP server, and can be viewed from the front panel using the Set/View IP Address commands (see PAR. 3.3.21 through 3.3.24). Figure 3-5 shows the commands used to set/view addresses depending on whether DHCP and DNS functions are on or off.

If a DHCP server is not available, this function should be set to OFF and the DNS function (PAR. 3.3.20) should be set to OFF. The current IP address can be then be viewed or set from the front panel using the Set/View IP Address commands (see PAR. 3.3.21 through 3.3.24). The IP address can be reset to the default 192.168.0.100 using IP Address Reset (see PAR. 3.3.49).

1. Enter the menu (see PAR. 3.2.2 and Table 3-3) and rotate the encoder until Voltage display shows  (DHCP) to access DHCP on/off setting.

2. Press ENTER key to view setting.

DHCP ON displayed as  (ON) in Current display.

DHCP OFF displayed as  (OFF) in Current display.

3. Rotate encoder until Current display shows desired setting, then press ENTER to confirm.

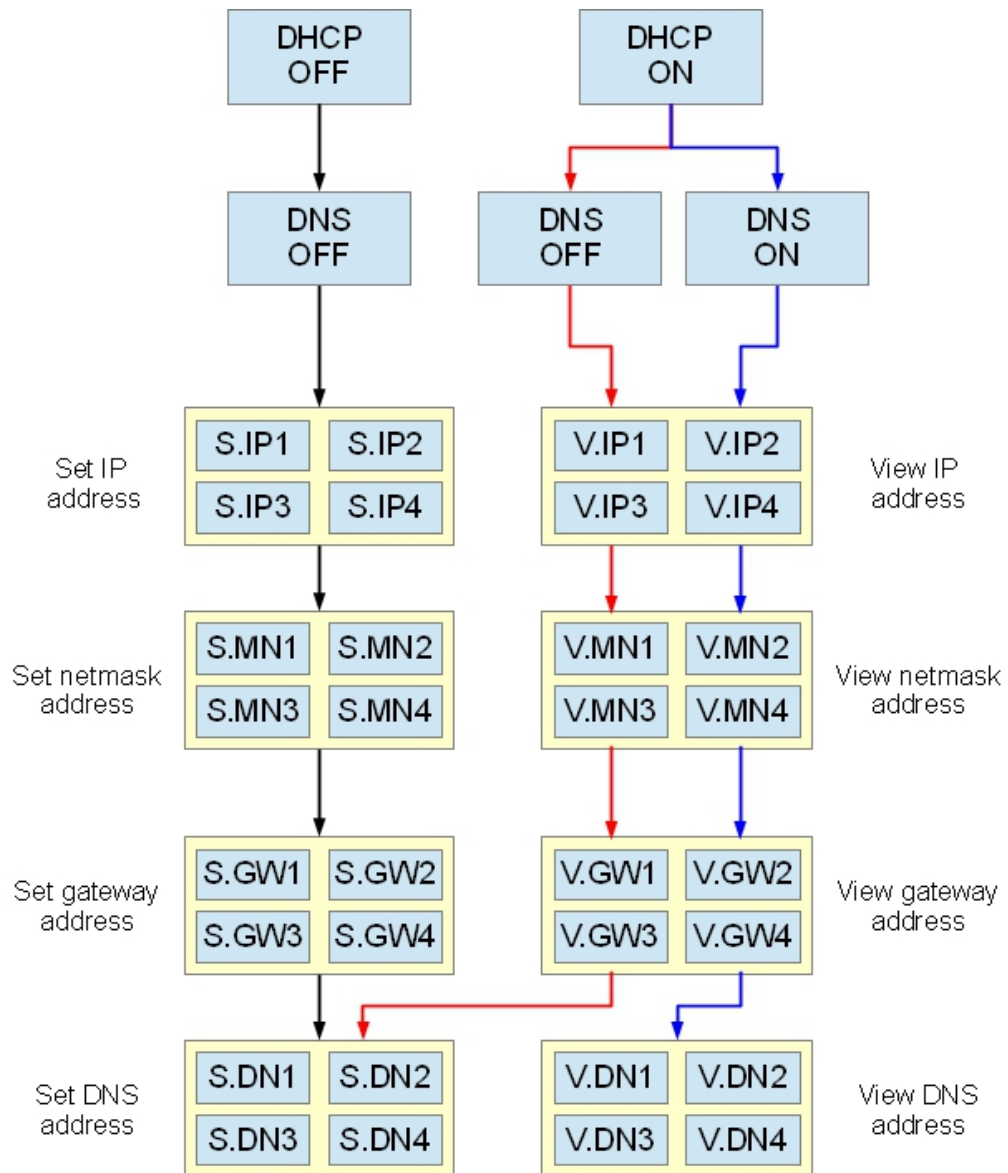

**FIGURE 3-5. VIEW/SET ADDRESS COMMANDS USED WITH DHCP AND DNS FUNCTIONS**

### 3.3.20 DNS FUNCTION ON/OFF CONTROL (LAN INTERFACE ONLY)

Used to determine how the DNS address is assigned. Set this function to ON when connecting to the network via a DHCP server to allow the server to assign the DNS server address. Set this function to OFF when connecting the KLN directly to a computer. Figure 3-5 shows the commands used to set/view addresses depending on whether DHCP and DNS functions are on or off.

1. Enter the menu (see PAR. 3.2.2 and Table 3-3) and rotate the encoder until Voltage display shows  (DNS) to access DNS on/off setting.

2. Press ENTER key to view setting.



DNS ON displayed as  (ON) in Current display.

DNS OFF displayed as  (OFF) in Current display.

3. Rotate encoder until Current display shows desired setting, then press ENTER to confirm.

### 3.3.21 SET/VIEW 1ST PART OF IP ADDRESS (LAN INTERFACE ONLY)

Used to set (if DHCP function is OFF) or view (if DHCP is ON) part 1 (nnn) of the 4-part IP address (nnn.xxx.xxx.xxx) where nnn can be set from 0 to 223. Refer to PAR. 3.3.19 to set DHCP on/off. When setting the IP address, verify that all four parts of the address are set correctly (see PARs. 3.3.22 through 3.3.24). Figure 3-5 shows the commands used to set/view addresses depending on whether DHCP and DNS functions are on or off.

1. Enter the menu (see PAR. 3.2.2 and Table 3-3) and rotate the encoder until Voltage display shows  (S.IP1) if DHCP is OFF or  (V.IP1) if DHCP is ON to access part 1 of IP address.



2. Press ENTER key to view setting.

For example,  (192) displayed in Current display for IP Address 192.xxx.xxx.xxx

3. If Voltage display shows  (S.IP1), set by rotating encoder until Current display shows desired setting (tap encoder to adjust 10's or 100's digit more rapidly). Press ENTER to confirm.

### 3.3.22 SET/VIEW 2ND PART OF IP ADDRESS (LAN INTERFACE ONLY)

Used to set (if DHCP function is OFF) or view (if DHCP is ON) part 2 (nnn) of the 4-part IP address (xxx.nnn.xxx.xxx) where nnn can be set from 0 to 254. Refer to PAR. 3.3.19 to set DHCP on/off. When setting the IP address, verify that all four parts of the address are set correctly (see PARs. 3.3.21, 3.3.23 and 3.3.24).



1. Enter the menu (see PAR. 3.2.2 and Table 3-3) and rotate the encoder until Voltage display shows  (S.IP2) if DHCP is OFF or  (V.IP2) if DHCP is ON to access part 2 of IP address.
2. Press ENTER key to view setting.

For example  (168) displayed in Current display for IP Address xxx.168.xxx.xxx.

3. If Voltage display shows  (S.IP2), set by rotating encoder until Current display shows desired setting (tap encoder to adjust 10's or 100's digit more rapidly). Press ENTER to confirm.

### 3.3.23 SET/VIEW 3RD PART OF IP ADDRESS (LAN INTERFACE ONLY)

Used to set (if DHCP function is OFF) or view (if DHCP is ON) part 3 (nnn) of the 4-part IP address (xxx.xxx.nnn.xxx) where nnn can be set from 0 to 254. Refer to PAR. 3.3.19 to set DHCP on/off. When setting the IP address, verify that all four parts of the address are set correctly (see PARs. 3.3.21, 3.3.22 and 3.3.24).



1. Enter the menu (see PAR. 3.2.2 and Table 3-3) and rotate the encoder until Voltage display shows  (S.IP3) if DHCP is OFF or  (V.IP3) if DHCP is ON to access part 3 of IP address.
2. Press ENTER key to view setting.

For example  (0) displayed in Current display for IP Address xxx.xxx.0.xxx.

3. If Voltage display shows  (S.IP3), set by rotating encoder until Current display shows desired setting (tap encoder to adjust 10's or 100's digit more rapidly). Press ENTER to confirm.

### 3.3.24 SET/VIEW 4TH PART OF IP ADDRESS (LAN INTERFACE ONLY)

Used to set (if DHCP function is OFF) or view (if DHCP is ON) part 4 (nnn) of the 4-part IP address (xxx.xxx.xxx.nnn) where nnn can be set from 0 to 254. Refer to PAR. 3.3.19 to set DHCP on/off. When setting the IP address, verify that all four parts of the address are set correctly (see PARs. 3.3.21 through 3.3.23).

1. Enter the menu (see PAR. 3.2.2 and Table 3-3) and rotate the encoder until Voltage display shows  (S.IP4) if DHCP is OFF or  (V.IP4) if DHCP is ON to access part 4 of IP address.



2. Press ENTER key to view setting.

For example,  (100) displayed in Current display for IP Address xxx.xxx.xxx.100.

3. If Voltage display shows  (S.IP4), set by rotating encoder until Current display shows desired setting (tap encoder to adjust 10's or 100's digit more rapidly). Press ENTER to confirm.

### 3.3.25 SET/VIEW 1ST PART OF SUBNET MASK ADDRESS (LAN INTERFACE ONLY)

Used to set (DHCP function is OFF) or view (DHCP is ON) part 1 (nnn) of the 4-part Subnet Mask address (nnn.xxx.xxx.xxx) where nnn is a number from 0 to 255. The default subnet mask address is 255.255.255.0. Refer to PAR. 3.3.19 to set DHCP on/off. When setting the subnet mask, verify that all four parts of the address are set correctly (see PARs. 3.3.26 through 3.3.28). Figure 3-5 shows the commands used to set/view addresses depending on whether DHCP and DNS functions are on or off.

1. Enter the menu (see PAR. 3.2.2 and Table 3-3) and rotate the encoder until Voltage display shows  (S.MN1) if DHCP is OFF or  (V.MN1) if DHCP is ON.

2. Press ENTER key to view setting.



For example,  (255) displayed in Current display for subnet mask address 255.xxx.xxx.xxx.

3. If Voltage display shows  (S.MN1), set by rotating encoder until Current display shows desired setting (tap encoder to adjust 10's or 100's digit more rapidly). Press ENTER to confirm.



### 3.3.26 SET/VIEW 2ND PART OF SUBNET MASK ADDRESS (LAN INTERFACE ONLY)

Used to set (DHCP function is OFF) or view (DHCP is ON) part 2 (nnn) of the 4-part Subnet Mask address (xxx.nnn.xxx.xxx) where nnn is a number from 0 to 255.

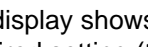

1. Enter the menu (see PAR. 3.2.2 and Table 3-3) and rotate the encoder until Voltage display shows  (S.MN2) if DHCP is OFF or  (V.MN2) if DHCP is ON.
2. Press ENTER key to view setting.

For example,  (255) displayed in Current display for subnet mask address xxx.255.xxx.xxx.

3. If Voltage display shows  (S.MN2), set by rotating encoder until Current display shows desired setting (tap encoder to adjust 10's or 100's digit more rapidly). Press ENTER to confirm.

### 3.3.27 SET/VIEW 3RD PART OF SUBNET MASK ADDRESS (LAN INTERFACE ONLY)

Used to set (DHCP function is OFF) or view (DHCP is ON) part 3 (nnn) of the 4-part Subnet Mask address (xxx.xxx.nnn.xxx) where nnn is a number from 0 to 255.

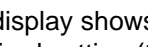

1. Enter the menu (see PAR. 3.2.2 and Table 3-3) and rotate the encoder until Voltage display shows  (S.MN3) if DHCP is OFF or  (V.MN3) if DHCP is ON.
2. Press ENTER key to view setting.

For example,  (255) displayed in Current display for subnet mask address xxx.xxx.255.xxx.

3. If Voltage display shows  (S.MN3), set by rotating encoder until Current display shows desired setting (tap encoder to adjust 10's or 100's digit more rapidly). Press ENTER to confirm.

### 3.3.28 SET/VIEW 4TH PART OF SUBNET MASK ADDRESS (LAN INTERFACE ONLY)

Used to set (DHCP function is OFF) or view (DHCP is ON) part 4 (nnn) of the 4-part Subnet Mask address (xxx.xxx.xxx.nnn) where nnn is a number from 0 to 255. The default subnet mask address is 255.255.255.0.

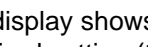

1. Enter the menu (see PAR. 3.2.2 and Table 3-3) and rotate the encoder until Voltage display shows  (S.MN4) if DHCP is OFF or  (V.MN4) if DHCP is ON.
2. Press ENTER key to view setting.

For example,  (0) displayed in Current display for subnet mask address xxx.xxx.xxx.0.

3. If Voltage display shows  (S.MN4), set by rotating encoder until Current display shows desired setting (tap encoder to adjust 10's or 100's digit more rapidly). Press ENTER to confirm.

### 3.3.29 SET/VIEW 1ST PART OF GATEWAY ADDRESS (LAN INTERFACE ONLY)

Used to set (DHCP function is OFF) or view (DHCP is ON) part 1 (nnn) of the 4-part Gateway address (nnn.xxx.xxx.xxx) where nnn is a number from 1 to 223. The default gateway address is 192.168.0.100. Refer to PAR. 3.3.19 to set DHCP on/off. When setting the gateway mask, verify that all four parts of the address are set correctly (see PARs. 3.3.30 through 3.3.31). Figure 3-5 shows the commands used to set/view addresses depending on whether DHCP and DNS functions are on or off.



1. Enter the menu (see PAR. 3.2.2 and Table 3-3) and rotate the encoder until Voltage display shows  (S.GW1) if DHCP is OFF or  (V.GW1) if DHCP is ON.
2. Press ENTER key to view setting.

For example,  (192) displayed in Current display for subnet mask address 192.xxx.xxx.xxx.

3. If Voltage display shows  (S.GW1), set by rotating encoder until Current display shows desired setting (tap encoder to adjust 10's or 100's digit more rapidly). Press ENTER to confirm.

### 3.3.30 SET/VIEW 2ND PART OF GATEWAY ADDRESS (LAN INTERFACE ONLY)

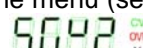
Used to set (DHCP function is OFF) or view (DHCP is ON) part 2 (nnn) of the 4-part Gateway address (xxx.nnn.xxx.xxx) where nnn is a number from 1 to 254.



1. Enter the menu (see PAR. 3.2.2 and Table 3-3) and rotate the encoder until Voltage display shows  (S.GW2) if DHCP is OFF or  (V.GW2) if DHCP is ON.
2. Press ENTER key to view setting.

For example,  (168) displayed in Current display for gateway address xxx.168.xxx.xxx.

3. If Voltage display shows  (S.GW2), set by rotating encoder until Current display shows desired setting (tap encoder to adjust 10's or 100's digit more rapidly). Press ENTER to confirm.

### 3.3.31 SET/VIEW 3RD PART OF GATEWAY ADDRESS (LAN INTERFACE ONLY)

Used to set (DHCP function is OFF) or view (DHCP is ON) part 3 (nnn) of the 4-part Gateway address (xxx.xxx.nnn.xxx) where nnn is a number from 1 to 254.



1. Enter the menu (see PAR. 3.2.2 and Table 3-3) and rotate the encoder until Voltage display shows  (S.GW3) if DHCP is OFF or  (V.GW3) if DHCP is ON.
2. Press ENTER key to view setting.

For example,  (0) displayed in Current display for gateway address xxx.xxx.0.xxx.

3. If Voltage display shows  (S.GW3), set by rotating encoder until Current display shows desired setting (tap encoder to adjust 10's or 100's digit more rapidly). Press ENTER to confirm.

### 3.3.32 SET/VIEW 4TH PART OF GATEWAY ADDRESS (LAN INTERFACE ONLY)

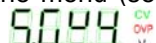
Used to set (DHCP function is OFF) or view (DHCP is ON) part 4 (nnn) of the 4-part Gateway address (xxx.xxx.xxx.nnn) where nnn is a number from 1 to 254.

Enter the menu (see PAR. 3.2.2 and Table 3-3) and rotate the encoder until Voltage display shows  (S.GW4) if DHCP is OFF or  (V.GW4) if DHCP is ON.



1. Press ENTER key to view setting.

For example,  (100) displayed in Current display for gateway address xxx.xxx.xxx.100.

2. If Voltage display shows  (S.MN4), set by rotating encoder until Current display shows desired setting (tap encoder to adjust 10's or 100's digit more rapidly). Press ENTER to confirm.

### 3.3.33 SET/VIEW 1ST PART OF DNS ADDRESS (LAN INTERFACE ONLY)

Used to set (DNS function is OFF) or view (DNS is ON) part 1 (nnn) of the 4-part DNS address (nnn.xxx.xxx.xxx) where nnn is a number from 1 to 223. The default DNS address is 8.8.8.8. Refer to PAR. 3.3.20 to set DNS on/off. When setting the DNS address, verify that all four parts of the address are set correctly (see PARs. 3.3.30 through 3.3.31). Figure 3-5 shows the commands used to set/view addresses depending on whether DHCP and DNS functions are on or off.

1. Enter the menu (see PAR. 3.2.2 and Table 3-3) and rotate the encoder until Voltage display shows  (S.DN1) if DNS is OFF or  (V.DN1) if DNS is ON.



2. Press ENTER key to view setting.

For example,  (8) displayed in Current display for DNS address 8.xxx.xxx.xxx.

3. If Voltage display shows  (S.GW1), set by rotating encoder until Current display shows desired setting (tap encoder to adjust 10's or 100's digit more rapidly). Press ENTER to confirm.

### 3.3.34 SET/VIEW 2ND PART OF DNS ADDRESS (LAN INTERFACE ONLY)

Used to set (DNS function is OFF) or view (DNS is ON) part 2 (nnn) of the 4-part DNS address (xxx.nnn.xxx.xxx) where nnn is a number from 1 to 254.

1. Enter the menu (see PAR. 3.2.2 and Table 3-3) and rotate the encoder until Voltage display shows  (S.DN2) if DNS is OFF or  (V.DN2) if DNS is ON.



2. Press ENTER key to view setting.

For example,  (8) displayed in Current display for DNS address xxx.8.xxx.xxx.

3. If Voltage display shows  (S.DN2), set by rotating encoder until Current display shows desired setting (tap encoder to adjust 10's or 100's digit more rapidly). Press ENTER to confirm.

### 3.3.35 SET/VIEW 3RD PART OF DNS ADDRESS (LAN INTERFACE ONLY)

Used to set (DNS function is OFF) or view (DNS is ON) part 3 (nnn) of the 4-part DNS address (xxx.xxx.nnn.xxx) where nnn is a number from 1 to 254.



1. Enter the menu (see PAR. 3.2.2 and Table 3-3) and rotate the encoder until Voltage display shows  (S.DN3) if DNS is OFF or  (V.DN3) if DNS is ON.
2. Press ENTER key to view setting.

For example,  (8) displayed in Current display for DNS address xxx.xxx.8.xxx.

3. If Voltage display shows  (S.DN3), set by rotating encoder until Current display shows desired setting (tap encoder to adjust 10's or 100's digit more rapidly). Press ENTER to confirm.

### 3.3.36 SET/VIEW 4TH PART OF DNS ADDRESS (LAN INTERFACE ONLY)

Used to set (DNS function is OFF) or view (DNS is ON) part 4 (nnn) of the 4-part DNS address (xxx.xxx.xxx.nnn) where nnn is a number from 1 to 254.

1. Enter the menu (see PAR. 3.2.2 and Table 3-3) and rotate the encoder until Voltage display shows  (S.DN4) if DNS is OFF or  (V.DN4) if DNS is ON.
2. Press ENTER key to view setting.

For example,  (100) displayed in Current display for DNS address xxx.xxx.xxx.100.

3. If Voltage display shows  (S.DN4), set by rotating encoder until Current display shows desired setting (tap encoder to adjust 10's or 100's digit more rapidly). Press ENTER to confirm.

### 3.3.37 PARALLEL/SERIAL MASTER/SLAVE SETUP

Used to establish unit as Master or Slave for parallel (maximum of five units including Master) or series operation (maximum of two units including Master).

1. Enter the menu (see PAR. 3.2.2 and Table 3-3) and rotate the encoder until Voltage display shows  (PSOP) to access Parallel/Serial Master/Slave Setting.
2. Press ENTER key to change setting.

Parallel Master displayed as  (PM) in Current display.

Parallel Slave displayed as  (PS) in Current display.

Serial Master displayed as  (SM) in Current display.

Serial Slave displayed as  (SS) in Current display.

3. Rotate encoder until Current display shows desired setting, then press ENTER to confirm.

### 3.3.38 EXTERNAL CONTROL OF OUTPUT ON/OFF

This function enables or disables external control of output on/off using the Programming Control port.

1. Enter the menu (see PAR. 3.2.2 and Table 3-3) and rotate the encoder until Voltage display shows  (EO.C) to access EXTERNAL OUTPUT ON/OFF CONTROL function.

OFF (default) displayed as  (OFF) in Current display.

ON displayed as  (ON) in Current display.

2. Press ENTER key to change setting. Rotate encoder until Current display shows desired setting, then press ENTER to confirm.

### 3.3.39 ENABLE VOLTAGE CONTROL VIA PROGRAMMING CONTROL PORT

Allows voltage control either from the front panel (LOCAL) or from the analog signal via the Programming Control port (EXTERNAL)

1. Enter the menu (see PAR. 3.2.2 and Table 3-3) and rotate the encoder until Voltage display shows  (CV.M) to access CONSTANT VOLTAGE MODE CONTROL setting.

2. Press ENTER key to view setting.

LOCAL (front panel) mode displayed as  (LOC) in Current display.

EXTERNAL (Programming Control port) mode displayed as  (EXT) in Current display.

3. Rotate encoder until Current display shows desired setting, then press ENTER to confirm.

### 3.3.40 ENABLE CURRENT CONTROL VIA PROGRAMMING CONTROL PORT

Allows current control either from the front panel (LOCAL) or from the analog signal via the Programming Control port (EXTERNAL)

1. Enter the menu (see PAR. 3.2.2 and Table 3-3) and rotate the encoder until Voltage display shows  (CC.M) to access CONSTANT CURRENT MODE CONTROL setting.

2. Press ENTER key to view setting.

LOCAL (front panel) mode displayed as  (LOC) in Current display.

EXTERNAL (Programming Control port) mode displayed as  (EXT) in Current display.

3. Rotate encoder until Current display shows desired setting, then press ENTER to confirm.



### 3.3.41 CALIBRATION ACCESS

Allows access to calibration mode which is password protected.

1. Enter the menu (see PAR. 3.2.2 and Table 3-3) and rotate the encoder until Voltage display shows  (CAL) to access CALIBRATION mode.
2. Press ENTER key to access setting (password).
3. Rotate encoder until Current display shows desired setting for blinking digit.
4. Tap encoder to go to next digit and repeat step 3 for all digits of the password, then press ENTER to confirm.
5. Refer to PAR. 4.1 to calibrate the unit.



### 3.3.42 VIEW SERIAL NUMBER

Allows viewing of 6-digit serial number.

1. Enter the menu (see PAR. 3.2.2 and Table 3-3) and rotate the encoder until Voltage display shows  (SN) in the two left-most characters.
2. Serial Number displayed starting with two right-most digits  (10) in Voltage display and four digits in Current display  (0000).



### 3.3.43 VIEW MAIN CONTROL VERSION

Allows viewing of main control firmware version

1. Enter the menu (see PAR. 3.2.2 and Table 3-3) and rotate the encoder until Voltage display shows  (FW). to view the unit main control version.
2. Main Control Version displayed as  1.00 (typical) in Current display.

### 3.3.44 VIEW HARDWARE VERSION

Allows viewing of hardware version

1. Enter the menu (see PAR. 3.2.2 and Table 3-3) and rotate the encoder until Voltage display shows  (HW). to view the unit hardware version.
2. Hardware Version displayed as  1.00 (typical) in Current display.

### 3.3.45 VIEW 1ST PART OF MAC ADDRESS (LAN INTERFACE ONLY)

Used to view first two hex numbers (aa.bb) of the 6-character MAC address (aa.bb.cc.dd.ee.ff) where aa and bb are Hex numbers from 00 to FF. The default MAC address is 70.60.42.00.00.00.

1. Enter the menu (see PAR. 3.2.2 and Table 3-3) and rotate the encoder until Voltage display shows  (V.MA1).
2. Press ENTER key to view setting.

For example,  (70.46) displayed in Current display for MAC address 70.46.42.00.00.00.

### 3.3.46 VIEW 2ND PART OF MAC ADDRESS (LAN INTERFACE ONLY)

Used to view second two hex numbers (cc.dd) of the 6-character MAC address (aa.bb.cc.dd.ee.ff) where cc and dd are Hex numbers from 00 to FF. The default MAC address is 70.60.42.00.00.00.

1. Enter the menu (see PAR. 3.2.2 and Table 3-3) and rotate the encoder until Voltage display shows  (V.MA2).
2. Press ENTER key to view setting.

For example,  (42.00) displayed in Current display for MAC address 70.60.42.00.00.00.

### 3.3.47 VIEW 3RD PART OF MAC ADDRESS (LAN INTERFACE ONLY)

Used to view third two hex numbers (ee.ff) of the 6-character MAC address (aa.bb.cc.dd.ee.ff) where ee and ff are Hex numbers from 00 to FF. The default MAC address is 70.60.42.00.00.00.

1. Enter the menu (see PAR. 3.2.2 and Table 3-3) and rotate the encoder until Voltage display shows  (V.MA3).
2. Press ENTER key to view setting.

For example,  (00.00) displayed in Current display for MAC address 70.60.42.00.00.00.

### 3.3.48 RESET

The RESET function resets the value of V set and A set to 0, resets the value of OVP and OCP to the default values (110% of rated voltage and 110% of rated current, respectively), resets undervoltage limit to 0, and sets the output to OFF.

1. Enter the menu (see PAR. 3.2.2 and Table 3-3) and rotate the encoder until Voltage display shows  (RST) to access RESET function.
2. Press ENTER key to view setting.

OFF (default) displayed as  (OFF) in Current display.

ON mode displayed as  (ON) in Current display to initiate RESET.

3. Rotate encoder until Current display shows , then press ENTER to confirm.

### 3.3.49 IP ADDRESS RESET (RST1)

The IP Address reset function resets the IP address to the default: 192.168.0.100/255.255.0.0 and clears both Gateway and DNS addresses.

1. Enter the menu (see PAR. 3.2.2 and Table 3-3) and rotate the encoder until Voltage display shows  (RST1) to access RESET IP ADDRESS function.

2. Press ENTER key to view setting.

OFF (default) displayed as  (oFF) in Current display.

ON mode displayed as  (on) in Current display to initiate RESET IP ADDRESS.

3. Rotate encoder until Current display shows , then press ENTER to confirm.

### 3.3.50 VIEWING ERROR CODES.

When the red  (alarm) LED on the front panel is lit, use the ERR function of the menu to read the error.

1. Enter the menu (see PAR. 3.2.2 and Table 3-3) and rotate the encoder until Voltage display shows  (ERR) to access Error Codes.

2. If an error was detected, a two or three digit number is shown in the Current display. Refer to Table B-2 for a complete list of error codes. If no error, code displayed in Current display is  (0, no error).

3. Press ENTER key to erase code in Current display and read the next error code. When Current display reads 0, all error codes have been read.

## 3.4 SERIES/PARALLEL OPERATION

The following paragraphs describe operation of multiple units connected in series or parallel

### 3.4.1 SERIES OPERATION

- The front panel voltage displays of the Master and Slave each show 1/2 of the total output voltage of the series combination. The front panel current display of the Master shows the current for the series combination
- The voltage monitoring function at pin 20 (V MON) of the Control Programming port is functional for both Master and Slave, 0 - 10V corresponding to 0 to full scale voltage of the individual units. Voltage monitor for the series combination is the sum of the output of pin 20 of the Master plus pin 20 of the Slave.
  - Output ON/OFF is controlled by the Master.
- The current monitoring function at pin 22 (A MON) of the Control Programming port is functional for both Master and Slave, 0 - 10V corresponding to 0 to full scale current of the individual units.



- The alarm status function at pin 9 (ALARM) of the Control Programming port is functional for both Master and Slave. If the Master alarm status is active, the Master and Slave will be shut down. If the Slave alarm status is active, only the Slave will be shut down.
- When using remote control, only the Master can be operated and controlled by remote commands.

To operate units connected in series, proceed as follows:

1. Verify that the units are connected as shown in Figure 2-19 (A, with local compensation or B with remote compensation)
2. Verify that Programming Control Port connections are as shown in either Figure 2-19 (using the optional Series Connector Board shown in Figure 2-20), or Figure 2-21 (direct connections).
3. Turn on power to Master unit first and then Slave unit.
4. Set PSOP (Parallel/Series operation) function in the menu to SM (Series Master) for the Master unit and to SS (Series Slave) for the Slave unit (see PAR. 3.3.37). After setting PSOP, output ON/OFF of the series combination is controlled by the Master.

**CAUTION: TO ENSURE THE PROTECTION FUNCTIONS WORK PROPERLY, SET OVP/OCV VALUES HIGHER FOR THE SLAVE UNIT.**

5. Set OVP and OVC of the Slave to a higher value than that for the Master to ensure that overvoltage and overcurrent protection work properly.
6. When powering off a series combination, first turn off the Slave, then the Master.

### **3.4.2 DISCONTINUING SERIES OPERATION**

To allow units connected in series to function independently, proceed as follows:

1. Turn off power to Slave, then Master.
2. Disconnect all series connections shown in Figure 2-19.
3. If applicable, disconnect Programming Control Port connections shown in Figure 2-21.
4. After turning on each unit, set PSOP (Parallel/Series operation) to PM (Parallel Master) in the Menu (see PAR. 3.3.37).

### 3.4.3 PARALLEL OPERATION

- The front panel current displays of the Master and Slave(s) each show the output current of the individual units. The front panel voltage display of the Master shows the output voltage for the parallel combination.
- Front panel keys of slave(s) are disabled, except that SHIFT and ENTER keys still allow access to the MENU functions (see PAR. 3.2.2) and SHIFT V (OVP) still allows OVP of the slave to be modified (see PAR. 3.3.2).
- The voltage monitoring function at pin 20 (V MON) of the Control Programming port is functional for the Master and all Slaves, 0 - 10V corresponding to 0 to full scale voltage of each individual unit.
- The current monitoring function at pin 22 (A MON) of the Control Programming port is functional for Master and all Slaves, 0 - 10V corresponding to 0 to full scale current of the individual units. Current monitor for the parallel combination is the sum of the output of pin 22 of the Master, plus pin 22 of all Slaves.
- The alarm status function at pin 9 (ALARM) of the Control Programming port is functional for Master and all Slaves. If the Master alarm status is active, the Master and all Slaves will be shut down. If a Slave alarm status is active, only that Slave will be shut down.
- Remote sensing for Slave units is disabled when operating in parallel configurations.
- When using remote digital control, only the MASTER can be operated and controlled by remote commands.

To operate units connected in parallel, proceed as follows:

1. Verify that the units are connected as shown in either Figure 2-22A (with local compensation) or Figure 2-22B (with remote compensation).
2. Verify that Programming Control Port connections are as shown in either Figure 2-22 (using the optional Parallel Connector Board shown in Figure 2-23), or Figure 2-24 (direct connections).
3. Turn on power to Master unit first, then Slave units.
4. Set menu function for Ramp Down Time of both Master and Slave to 0 (see PAR. 3.3.11).
5. Set PSOP (Parallel/Series operation) function in the menu to PM (Parallel Master) for the Master unit and to PS (Parallel Slave) for the Slave unit (see PAR. 3.3.37). After setting PSOP, output ON/OFF of the series combination is controlled by the Master.
6. Set OVP and OVC of the Slave(s) to a higher value than that for the Master to ensure that overvoltage and overcurrent protection work properly.
7. When powering off a parallel combination, first turn off the Slave(s), then the Master.

### 3.4.4 DISCONTINUING PARALLEL OPERATION

To allow units connected in parallel to function independently, proceed as follows:

1. Turn off power to Slaves, then Master.
2. Disconnect all parallel connections shown in Figure 2-22.
3. If applicable, disconnect Programming Control Port connections shown in Figure 2-24.
4. After turning on each unit, set PSOP (Parallel/Series operation) to PM (Parallel Master) in the Menu (see PAR. 3.3.37).

### 3.5 ANALOG REMOTE MODE PROGRAMMING

The KLN can be programmed remotely using analog signals applied to the remote Programming Control port at the rear panel (see Figure 2-1 and Table 2-4). Analog remote programming allows the user to 1) control output on/off (PAR. 3.5.1), 2) initiate emergency shutdown of the output (PAR. 3.5.2), 3) control output voltage (PAR. 3.5.3) or current (PAR. 3.5.4) and 4) monitor power supply status (PAR. 3.5.6).

#### 3.5.1 REMOTE OUTPUT ON/OFF

The output can be set on or off using the Programming Control port pins 21 and 25 (non-isolated). When the pins are shorted the output is on, when they are open the out is off. This can be accomplished using either an optocoupler or relay. (See Figure 3-7). This feature must first be enabled from the front panel by setting external control of output on/off to ON (see PAR. 3.3.38). Use 5V supply from pins 13 and 14 (isolated) to power optocoupler or relay.

#### 3.5.2 REMOTE EMERGENCY SHUTDOWN

Remote emergency shutdown of the output can be accomplished using Programming Control port pins 23 and 25 and either an optocoupler or relay. (See Figure 3-6). When the pins are open, operation is normal. When they are shorted, the output is immediately set to off, the red (alarm) LED goes on, the unit beeps and error 77 is recorded. This happens regardless of the status of output on/off at pin 10 and whether external control of output on/off (see PAR. 3.3.38) is enabled or disabled.

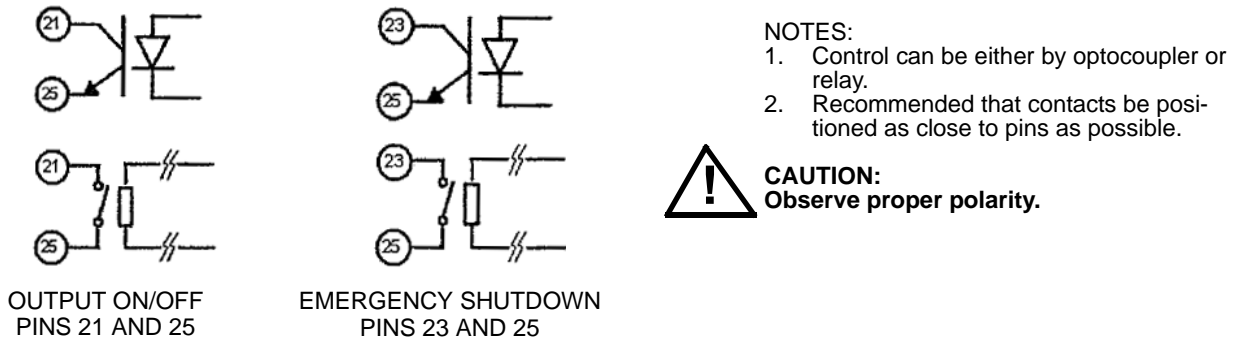

FIGURE 3-6. REMOTE CONTROL USING PROGRAMMING CONTROL PORT AND OPTOCOUPLER OR RELAY

### 3.5.3 REMOTE CONTROL OF OUTPUT VOLTAGE USING AN ANALOG SIGNAL

Connect an analog voltage, adjustable from 0 to +10V d-c (corresponding to 0 to rated output voltage) between pin 16 (+) and pin 26 (–) of the Programming Control Port. The analog voltage will control the output only after the function is enabled by setting Constant Voltage control to EXT from the front panel (see PAR. 3.3.39).



**CAUTION: TO AVOID OVP TRIPPING WHEN THE OUTPUT IS SET TO ON, THE ANALOG PROGRAMMING VOLTAGE MUST NOT EXCEED 10.5V D-C.**

### 3.5.4 REMOTE CONTROL OF OUTPUT CURRENT USING AN ANALOG SIGNAL

Connect an analog voltage, adjustable from 0 to +10V d-c (corresponding to 0 to rated output current) between pin 18 (+) and pin 26 (–) of the Programming Control Port. The analog voltage will control the output only after the function is enabled by setting Constant Current control to EXT from the front panel (see PAR. 3.3.40).

**CAUTION: TO AVOID OCP TRIPPING WHEN THE OUTPUT IS SET TO ON, THE ANALOG PROGRAMMING VOLTAGE MUST NOT EXCEED 10.5V D-C.**

### 3.5.5 RECALLING PREVIOUSLY STORED SETTING USING PROGRAMMING CONTROL PORT

Connect a switch or relay (dry contactor) across pins 1 and 2 of the Programming Control Port. Each time the pins are shorted together is equivalent to pressing the RCL key (see PAR. 3.3.7). Closures of the switch or relay can be used to select the desired memory cell.

### 3.5.6 MONITORING OUTPUT STATUS USING PROGRAMMING CONTROL PORT

The Programming Control port allows monitoring of output voltage and current, operating mode (CC or CV), power on/off, output on/off and alarm status (occurrence of OVP, OCP, or output shutdown).

#### 3.5.6.1 MONITOR OUTPUT VOLTAGE OR CURRENT



**CAUTION: DO NOT ALLOW SHORT BETWEEN PROGRAMMING CONTROL PORT PINS 20 (A MONITOR), 22 (V MONITOR) OR 24 (ANALOG COMMON) TO AVOID DAMAGE TO THE UNIT.**

Voltage: The analog voltage between 0 to +10V d-c at pin 20, referenced to pin 24, represents 0 to the rated voltage of the unit. Accurate within 5% of Voltage display reading. Output resistance: approximately 100 Ohms, maximum output current: approximately 10mA.

Current: The analog voltage between 0 to +10V d-c at pin 22, referenced to pin 24, represents 0 to the rated current of the unit. Accurate within 5% of Current display reading. Output resistance: approximately 100 Ohms, maximum output current: approximately 10mA.

### 3.5.6.2 MONITOR UNIT STATUS

The following status signals are open collector TTL signals via an optocoupler referenced to Programming Control port pin 8: maximum voltage is 30V, maximum current is 8mA. See Figure 3-7. Status noted in Figure 3-7 is present when signal is TTL high, absent when TTL low.

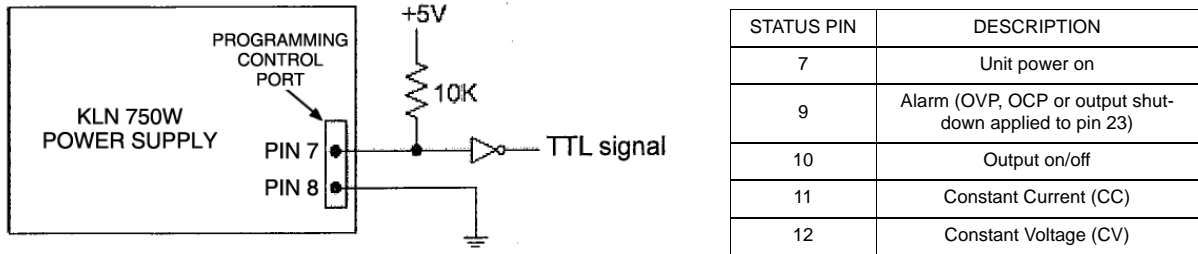

FIGURE 3-7. PROGRAMMING CONTROL PORT STATUS MONITORING

## 3.6 DIGITAL REMOTE MODE PROGRAMMING

KLN models may be digitally programmed over a control bus using SCPI (Standard Commands for Programmable Instruments). SCPI provides a common language conforming to IEEE 488.2 for instruments used in an automatic test system (see PAR. 3.7). The control bus used must be either the RS-485 Serial Bus, or the optional IEEE 488 standard communication bus (General Purpose Interface Bus, GPIB) or the optional LAN interface. Refer to PAR. 3.7 for a detailed discussion of SCPI programming.

Refer to Table 2-3 for input/output signal allocations for communication via the GPIB and Table 2-2 for RS-485.

This section includes the requirements for

- RS 485 Operation (see PAR. 3.6.1)
- GPIB Operation if option installed (see PAR. 3.6.2) including an explanation of GPIB bus protocols (PAR. 3.6.2.1)
- LAN Operation if option installed (see PAR. 3.6.3)

### 3.6.1 RS-485 OPERATION

See PAR. 2.7.2 for RS-485 connections.

See PAR. 3.3.18 to change the RS-485 Address.

See PAR. 3.3.16 to change the RS-485 Baud Rate.

### 3.6.2 GPIB OPERATION (IF OPTION INSTALLED)

See PAR. 2.7.4 for GPIB connections.

See PAR. 3.3.17 to change the GPIB Address.

### 3.6.2.1 IEEE 488 (GPIB) BUS PROTOCOL

Table 3-4 defines the interface capabilities of the KLN power supply (Talker/Listener) relative to the IEEE 488 (GPIB) bus (reference document *ANSI/IEEE Std 488: IEEE Standard Digital Interface for Programmable Instrumentation*) communicating with a Host Computer—Controller (Talker/Listener). Tables 3-5 and 3-6 define the messages sent by the KLN, or received by the KLN, via the IEEE 488 bus in IEEE 488 command mode and IEEE 488 data mode, respectively. These messages are enabled during the “handshake” cycle, with the KLN power supply operating as either a Talker or a Listener.

**TABLE 3-4. IEEE 488 (GPIB) BUS INTERFACE FUNCTIONS**

<b>FUNCTION</b>	<b>SUBSET SYMBOL</b>	<b>COMMENTS</b>
Source Handshake	SH1	Complete Capability (Interface can receive multi-line messages)
Acceptor Handshake	AH1	Complete Capability (Interface can receive multi-line messages)
Talker	T6	Basic talker, serial poll, unaddress if MLA (My Listen Address) (one-byte address)
Listener	L4	Basic listener, unaddress if MTA (My Talk Address) (one-byte address).
Service Request	SR0	No Capability.
Remote/Local	RL1	Complete capability. Interface selects either local or remote information. In local mode the KLN executes front panel commands, but can be set to remote mode via IEEE 488 bus. When in Remote mode all front panel keys are disabled except LOCAL function key.
Parallel Poll	PP0	No Capability
Device Clear	DC1	Complete Capability. KLN accepts DCL (Device Clear) and SDC (Selected Device Clear).
Device Trigger	DT0	No Capability
Controller	C0	No Capability

**TABLE 3-5. IEEE 488 (GPIB) BUS COMMAND MODE MESSAGES**

<b>MNEMONIC</b>	<b>MESSAGE DESCRIPTION</b>	<b>COMMENTS</b>
ATN	Attention	Received
DAC	Data accepted	Received or Sent
DAV	Data Valid	Received or Sent
DCL	Device Clear	Received
IFC	Interface Clear	Received
MLA	My Listen Address	Received
MTA	My Talk Address	Received
OTA	Other Talk Address	Received
RFD	Ready for Data	Received or Sent
SDC	Selected Device Clear	Received
SPD	Serial Poll Disable	Received
SPE	Serial Poll Enable	Received
SRQ	Service Request	Sent
UNL	Unlisten	Received
UNT	Untalk	Received

**TABLE 3-6. IEEE 488 (GPIB) BUS DATA MODE MESSAGES**

<b>MNEMONIC</b>	<b>MESSAGE DESCRIPTION</b>	<b>COMMENTS</b>
DAB	Data Byte	Received or Sent
END	End	Received or Sent
EOS	End of String	Received or Sent
RQS	Request Service	Sent
STB	Status Byte	Sent

### 3.6.3 LAN OPERATION (IF OPTION INSTALLED)

1. Connect the KLN to the computer (see PAR. 2.7.5 for LAN connections)
2. At the KLN front panel, set the I/O interface to LAN (see PAR. 3.3.15)
3. At the computer, enter the KLN IP address in a web browser. The factory default IP Address is 192.168.0.100. See PAR. 3.3.21 through PAR. 3.3.24 to view the current IP address or change it if needed. The web browser displays the Instrument Welcome Page as shown in Figure 3-8. The information displayed can not be changed from this page. Clicking adjacent to Device Indicator at the bottom of the page causes the LAN indicator on the KLN rear panel (see Figure 2-4 and Table 2-1) to either be on steady (INACTIVE) or to flash (ACTIVE).



## Programmable DC Power Supply

[Home](#)

[Network Status](#)

[Network Configuration](#)

[Instrument Control](#)

[Security](#)

### Instrument Welcome Page

Model	KLN 30-25
Manufacturer	KEPCO
Serial Number	500354
Description	Programmable DC Power Supply
LXI Extended Features	
LXI Version	1.4 LXI Device Specification 2011
Host Name	DCPOWER.local.
MAC Address	70-46-42-00-04-2B
TCP/IP Address	192.168.1.21
Firmware Revision	01.70
VISA Address String	TCPIP0::192.168.1.21::5025::SOCKET
Device Indicator	<input type="button" value="INACTIVE"/>

3043740

FIGURE 3-8. KLN INSTRUMENT WELCOME PAGE



### 3.6.3.1 NETWORK STATUS

Clicking Network Status at the top left shows the Network Status Page (see Figure 3-9). Data displayed can not be changed from this page.

#### Network Status Information

TCP/IP Configuration	
IP Address	192.168.2.185
IP Subnet Mask	255.255.255.0
Default Gateway	192.168.2.251
Preferred DNS Server	8.8.8.8
Alternate DNS Server	168.95.1.1
IP Configured By	DHCP
DNS Configured By	Auto
DHCP Server	192.168.2.251
Network Identification	
Host Name	DCPOWER
Domain Name	idrcis.com.tw
Service Name	Programmable DC Power Supply
mDNS Domain Name	DCPOWER.local
mDNS Discovery	Enabled
Network Hardware Configuration	
MAC Address	70-46-42-00-04-0C
Link Speed and Duplex Mode	100 Mbps full duplex

3043742

FIGURE 3-9. NETWORK STATUS PAGE

### 3.6.3.2 VIEWING AND/OR CHANGING IP CONFIGURATION

Clicking Network Configuration brings up the Log in screen (see Figure 3-10). Enter the password (admin is the default password) and click SUBMIT to continue and view the Network Configuration Page (see Figure 3-11).

The screenshot shows a web form titled "Log in" with a blue header. Below the header is a text input field labeled "Password" and a "submit" button.

3043743

FIGURE 3-10. LOG IN SCREEN

## IP Configuration

Host Name	DCPOWER			
Description	Programmable DC Power Supply			
Domain				
mDNS Discovery	<input type="radio"/> Disabled <input checked="" type="radio"/> Enabled			
<input type="button" value="Apply"/> <input type="button" value="Cancel"/>				
<b>Warning: Changes to these settings may result in loss of connectivity with the device.</b>				
IP Address from	<input type="radio"/> DHCP+AutoIP <input checked="" type="radio"/> Manual			
IP Address	192	168	0	100
Subnet Mask	255	255	255	0
Default Gateway	192	168	2	251
DNS Server Address from	<input type="radio"/> Auto <input checked="" type="radio"/> Manual			
Preferred DNS Server	8	8	8	8
Alternate DNS Server	168	95	1	1
Socket Port	5025			
<input type="button" value="Apply"/> <input type="button" value="Cancel"/> <input type="button" value="LAN Configuration Initialize"/>				

3043744

**FIGURE 3-11. NETWORK CONFIGURATION PAGE**

The four fields of the top section allow the user to set **Host Name**, **Description** and **Domain** as well as enable or disable **mDNS Discovery**. Using mDNS allows the KLN to determine the IP address of a given host (a host name) without the direct help of a centralised DNS server. Once changes have been made, immediately below the top section click on **Cancel** to revert to the previous settings, or **Apply** to apply the changes.

The lower section determines where the IP Address and DNS Server address comes from, and can be used to manually change the Socket Port from 5025 (the default) if needed. Setting **IP Address From** to **DHCP-Auto** allows the IP, Subnet Mask and Default Gateway addresses to be found automatically. If **IP Address From** is set to Manual the user can enter the desired addresses, Similarly, Setting **DNS Server Address From** to **Auto** or **Manual** allows Preferred and Alternate DNS addresses to be found automatically or be assigned by the user. Once changes have been made, immediately below the lower section click on **Cancel** to revert to the previous settings, or **Apply** to apply the changes. Clicking on **LAN Configuration Initialize** will restore the IP Configuration Settings to the factory default.

### 3.6.3.3 CHANGING LAN PASSWORD

When operating the KLN via the LAN for the first time, click Security at the top left of the Welcome Page to bring up the Change Password screen (Figure 3-12). If desired, change the old password from the default (admin) to one of your choosing. Ensure that New Password and Confirm Password fields are identical. If the password is lost, it can be reset to “admin” by executing the IP Address Reset (RST1) from the front panel (see PAR. 3.3.49). **however this will also reset other LAN settings to the default as well.**



FIGURE 3-12. CHANGE PASSWORD SCREEN

### 3.6.3.4 INSTRUMENT CONTROL

The Instrument Control page (see Figure 3-13) contains the basic controls used to operate the KLN power supply. To view the Instrument Control page, click on Instrument Control at the top left of the Welcome page. You may be asked to Log In with a password before access to this screen is granted. Voltage and current setpoints are displayed above the empty fields above the **Set V** and **Set I** buttons, respectively. The output can be enabled by the OUTPUT ON/OFF button at the right. If the output is on, the ON indicator (at the lower left of the group of six indicators) is on, and the voltage and current displayed appear at the output. To program voltage/current, enter the setpoint value in the field above the corresponding SET button, then click the SET button to apply the change. The CC, CV, OCP, OVP ON and Alarm indicators correspond to the front panel indicators (see Figure 3-1 (750W), 3-2 (1500W), or 3-3 (3000W), and Table 3-1. The RESET button corresponds to the front panel RESET button.



FIGURE 3-13. INSTRUMENT CONTROL PAGE

### 3.6.3.5 OPERATION VIA HYPERTERMINAL.

HyperTerminal can be used to operate the unit remotely via the LAN connection or it can be used to verify the LAN connection is operating properly.

1. From the computer, launch HyperTerminal (e.g., Start - Programs - Accessories - Communications - HyperTerminal) and key in the name of the connection, e.g., KLN 20-38E.



**FIGURE 3-14. OPEN HYPERTERMINAL CONNECTION**

2. At the “Properties” dialog box, open the “Connect using” drop-down menu and select “TCP/IP(Winsock)” then key in the Host address (see PAR. 3.3.21 through 3.3.24) and socket port (5025). HyperTerminal window shows screen with blinking cursor while connecting.
  - a. If a Message box opens that says “Unable to Connect to 192.168.0.100 port 5025” click OK, then click File - Properties at the top menu bar of the HyperTerminal window to open the Properties Dialog Box (Figure 3-15).

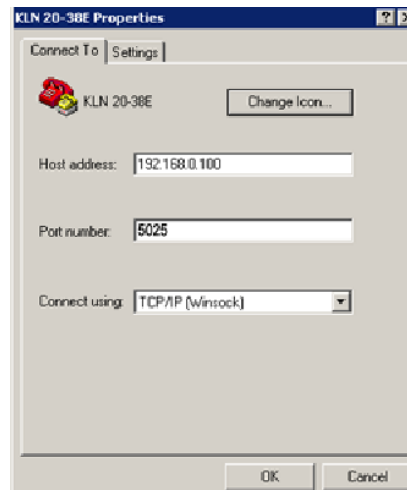

**FIGURE 3-15. HYPER TERMINAL PROPERTIES**

- b. Click the Settings tab, then click ASCII setup (see Figure 3-16).

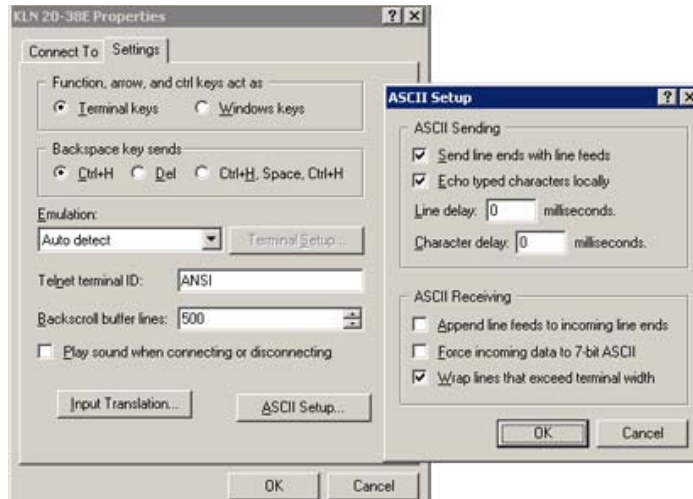

**FIGURE 3-16. HYPER TERMINAL ASCII SETUP**

- c. Check the “Send line ends with line feeds” and “Echo typed characters locally” boxes.
3. Repeat steps 1 and 2, then, from the computer via the blank HyperTerminal screen, send `sys:rem` and ENTER. The green remote  LED at the KLN front panel goes on.
4. Send `*idn?` query to verify unit is operating properly via the LAN interface. A typical response for a successful LAN connection is:
 

**KEPC0,KLN 20-38E,500354,01.60**
5. Send SCPI commands (see PAR. 3.7 and Appendix A and B) to drive the unit.

### 3.7 SCPI PROGRAMMING

SCPI (Standard Commands for Programmable Instruments) is a programming language conforming to the protocols and standards established by IEEE 488.2 (reference document *ANSI/IEEE Std 488.2, IEEE Standard Codes, Formats, Protocols, and Common Commands*). The KLN Power Supply supports long and short form syntax as defined in this standard. All other aspects of this standard are specified in Appendix B of this manual. The unit ignores all incorrectly formatted messages, emitting an audible beep for each incorrect command sequence; the reason for the beep is placed in the error queue.

Different programming languages (e.g., BASIC, C, PASCAL, etc.) have different ways of representing data that is to be put on the IEEE 488 bus. It is up to the programmer to determine how to output the character sequence required for the programming language used. See Table 3-7 for VISA resource strings corresponding to RS-485, GPIB (G-suffix models only) or LAN (E-suffix models only) interfaces.

**TABLE 3-7. VISA RESOURCE STRING CORRESPONDING TO INTERFACE**

INTERFACE	VISA RESOURCE STRING	COMMENT
GPIB	GPIB::xx::INSTR	The GPIB address replaces xx. Address information not included with command sequences. See PAR. 3.3.17 to set GPIB address.
RS-485	ASRLy::INSTR	The com port number replaces y. RS 485 address must be included in each command sequence. See PAR. 3.3.18 to set RS-485 address.
LAN	TCIP::192.168.0.100::5025::SOCKET	5025 is the default socket. See PAR 3.6.3.2 to verify or change the socket port. Address information not included with command sequences.

### **3.7.1 SCPI MESSAGES**

There are two kinds of SCPI messages: program messages from controller to power supply, and response messages from the power supply to the controller. Program messages consist of one or more properly formatted commands/queries and instruct the power supply to perform an action; the controller may send a program message at any time. Response messages consist of formatted data; the data can contain information regarding operating parameters, power supply state, status, or error conditions.

### **3.7.2 COMMON COMMANDS/QUERIES**

Common commands and queries are defined by the IEEE 488.2 standard to perform overall power supply functions (such as identification, status, or synchronization) unrelated to specific power supply operation (such as setting voltage/current). Common commands and queries are preceded by an asterisk (\*) and are defined and explained in Appendix A.

### **3.7.3 SCPI SUBSYSTEM COMMAND/QUERY STRUCTURE**

Subsystem commands/queries are related to specific power supply functions (such as setting output voltage, current, etc.) Figure 3-17 is a tree diagram illustrating the structure of SCPI subsystem commands used in the KLN Power Supply with the root at the left side, and specific commands forming the branches. The following paragraphs introduce the subsystems; subsystem commands are defined and explained in Appendix B.

#### **3.7.3.1 CALIBRATE SUBSYSTEM**

This subsystem is used to calibrate the unit, however these commands and queries are not accessible to the user.

#### **3.7.3.2 DISPLAY SUBSYSTEM**

This subsystem is used to set and ascertain the brightness on the front panel Voltage and Current displays.

#### **3.7.3.3 FETCH SUBSYSTEM**

This subsystem is used to measure and return both voltage and current measurements.

#### **3.7.3.4 OUTPUT SUBSYSTEM**

This subsystem is used to control whether the output is on or off, and whether the power supply powers up with the output set to the reset state or to the last settings in effect when the unit was powered off.

#### **3.7.3.5 SOURCE SUBSYSTEM**

This subsystem is used to program the output voltage and current of the power supply, associated protection levels and limits and output ramp up and down times. This subsystem is also used to control the memory locations used to store power supply settings for later recall.

#### **3.7.3.6 SYSTEM SUBSYSTEM**

This subsystem is used to control the audible beep upon key presses, enabling/disabling the front panel keys and reading of error codes and SCPI version.

### 3.7.4 UNDERSTANDING THE COMMAND STRUCTURE

Understanding the command structure requires an understanding of the subsystem command tree illustrated in Figure 3-17. The “root” is located at the top left corner of the diagram. The parser goes to the root if:

- a message terminator is recognized by the parser
- a root specifier is recognized by the parser

Starting at the root, there are various branches or paths corresponding to the subsystems. The root keywords for the KLN Power Supply are :CALibrate, :DISPlay, :FETCh, :OUTPut, :SOURce and :SYSTem.

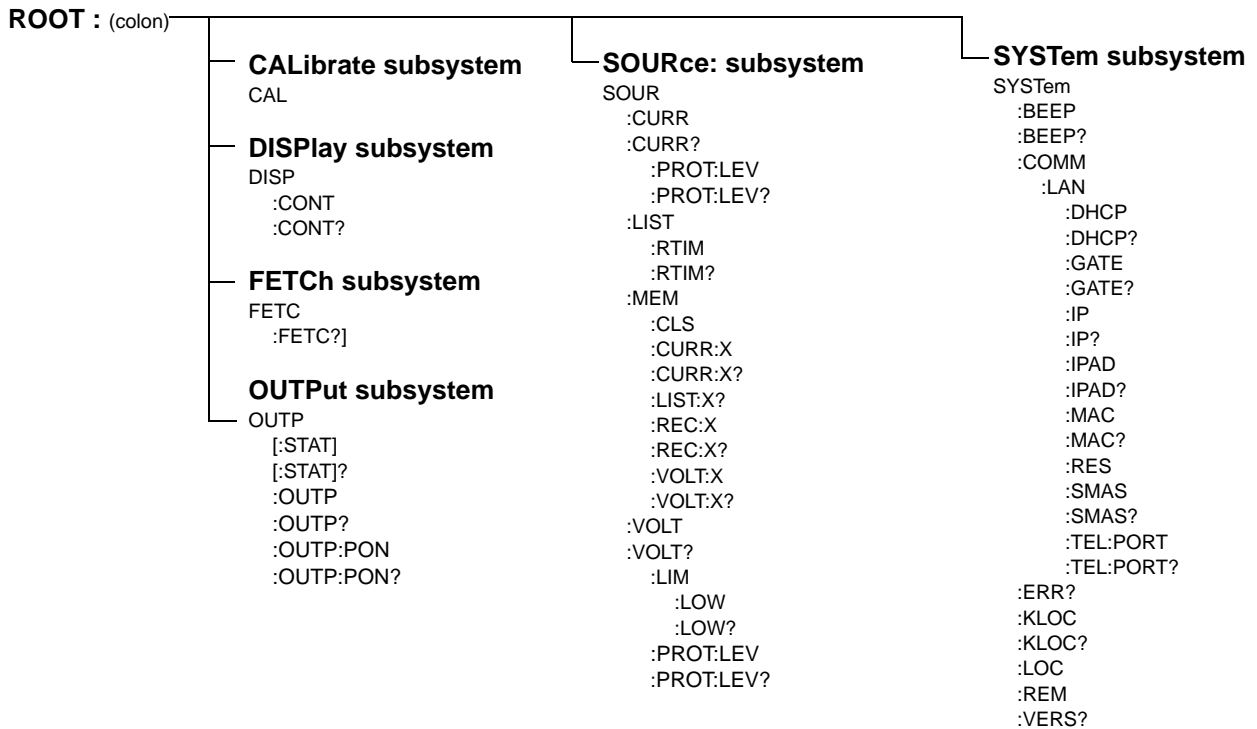

FIGURE 3-17. TREE DIAGRAM OF SCPI COMMANDS USED WITH KLN POWER SUPPLY





## SECTION 4 - CALIBRATION

### 4.1 GENERAL

This section contains the calibration instructions for the Power Supply. It is recommended that the user be familiar with Local Mode operation (PAR. 3.3) before calibrating the unit.

**CAUTION: IT IS RECOMMENDED THAT CALIBRATION BE PERFORMED ONLY BY AUTHORIZED PERSONNEL FAMILIAR WITH ELECTRONIC TEST AND CALIBRATION EQUIPMENT.**

A full calibration consist of a voltage calibration and a current calibration. Both voltage and current calibrations consist of a full scale calibration.

Calibration of the KLN is performed locally using the front panel controls

NOTE: Calibration of a master/slave configuration requires that both units be restored to standalone operation (see PAR. 3.4.2 or 3.4.4 for instructions) and calibrated individually.

### 4.2 EQUIPMENT REQUIRED

The following equipment is required to calibrate the KLN Power Supply.

- Digital Voltmeter (DVM) with 6 digits resolution and at least 0.002% accuracy for d-c measurements.

NOTE: Because the voltage measured will be used as a reference for calibration, the DVM used must be accurately calibrated prior to calibrating the power supply.

- Precision Shunt Resistor (with a tolerance of 0.01%, power rating of at least 10 times larger than the maximum stress, and a temperature coefficient equal to or better than 20 ppm per degree C).

NOTE: Proper cooling of the external precision shunt resistor ensures the accuracy of the calibration.

### 4.3 VOLTAGE CALIBRATION PROCEDURE

1. Turn off power supply and disconnect load from output terminals at the rear of unit.
2. Verify that power supply is configured for local error sensing (PAR. 2.5.7) and connect unit as shown in Figure 4-1.
3. Connect DVM to points "A" of sense terminal block at the rear of power supply as shown in Figure 4-1.

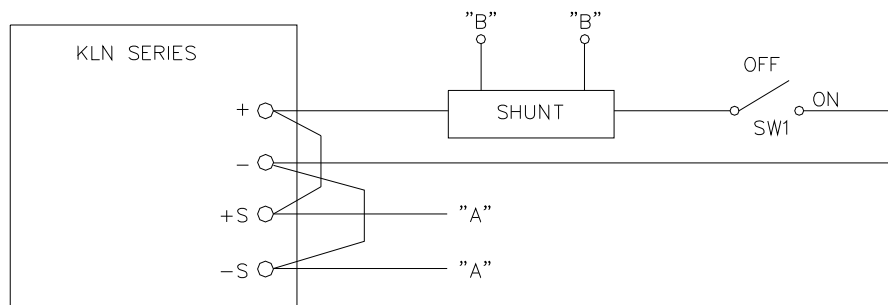

3043671

NOTE: CONNECT DVM TO POINTS "A" OR "B" AS DIRECTED BY PROCEDURE.

**FIGURE 4-1. CALIBRATION SETUP**

4. Turn on power to the KLN power supply.
5. At KLN front panel, press SHIFT, then press V/OVP key. Use encoder to set Overvoltage protection (see PAR. 3.3.2) to maximum (110% of rated voltage).
6. Press SHIFT, then press A/OCP key. Use encoder to set Overcurrent protection (see PAR. 3.3.3) to maximum (110% of rated current).
7. Press V/OVP key and use encoder to set voltage (see PAR. 3.3.2) to rated voltage of the unit as shown on front panel display.
8. Press A/OCP key and use encoder to set current (see PAR. 3.3.3) to rated current of the unit as shown on front panel display.
9. Refer to Figure 4-1 and set switch SW1 to OFF position.
10. Press OUT key to enable the output.
11. Record voltage shown on front panel display.
12. Record voltage at +S and -S sense terminals using the DVM connected to points "A" as shown in Figure 4-1.
13. Press OUT key to disable the output.
14. Use the menu to gain access to calibration (see PAR. 3.3.41) using password 5958.
15. The Voltage display shows VOL.r and the Current display shows the Voltage Deviation Ratio setting in effect:
 
$$\text{Voltage Deviation Ratio} = \text{DVM reading} / \text{Front panel reading}$$
16. Press ENTER key to access setting.
17. Calculate the new Voltage Deviation Ratio = (step 12 value)/(step 11 value).

18. Enter the new Voltage Deviation ratio by rotating encoder until Current display shows desired setting for blinking digit. Tap encoder to go to next digit and repeat for all digits, then press ENTER to confirm.

NOTE: If necessary to recalibrate, set Voltage Deviation Ratio to 1.000 and repeat Voltage Calibration procedure.

19. Press SHIFT and ENTER keys to exit.

20. Turn off power to the unit, disconnect DVM and proceed to Current Calibration (PAR. 4.4).

#### **4.4 CURRENT CALIBRATION PROCEDURE**

NOTE: This procedure continues from step 20 of Voltage Calibration procedure above.

1. Verify power is off. Connect DVM to points "B" across shunt resistor terminals as shown in Figure 4-1 and set switch SW1 to ON position.

2. Turn on power to the unit and press OUT key to enable the output.

3. Record current displayed on front panel.

4. Connect DVM to points "B" as shown in Figure 4-1, then measure voltage across shunt (DVM reading) and use this value to calculate output current using  $I \text{ (Amperes)} = E/R$  where E is the voltage across the shunt (Volts) and R is the value of the shunt resistor (ohms). Record calculated value.

5. Press OUT key to disable the output.

6. Use the menu to gain access to calibration (see PAR. 3.3.41) using password 5958.

7. Rotate encoder until the Voltage display shows Cur.r and the Current display shows the Current Deviation Ratio setting in effect:

Current Deviation Ratio = measured output current/front panel reading

8. Calculate the new Current Deviation Ratio = (step 4 value)/(step 3 value).

9. Press ENTER key to access setting.

10. Enter the new Current Deviation Ratio by rotating encoder until Current display shows desired setting for blinking digit. Tap encoder to go to next digit and repeat for all digits, then press ENTER to confirm.

NOTE: If necessary to recalibrate, set Current Deviation Ratio to 1.000 and repeat Current Calibration procedure.

11. Press SHIFT and ENTER keys to exit.

12. Turn off power to the unit, disconnect DVM and disconnect shunt.



## APPENDIX A - SCPI COMMON COMMAND/QUERY DEFINITIONS

### A.1 INTRODUCTION

This appendix defines the SCPI common commands and queries used with the KLN power supply. Common commands and queries are preceded by an asterisk (\*) and are defined and explained in paragraphs A.2 through A.5, arranged in alphabetical order. Table A-1 provides a quick reference of all SCPI common commands and queries used in the Interface Card.

**TABLE A-1. IEEE 488.2 COMMAND/QUERY INDEX**

COMMAND	PAR.	COMMAND	PAR.
*CLS	A.2	*RST	A.4
*IDN?	A.3	*TST?	A.5

### A.2 \*CLS — CLEAR STATUS COMMAND

**\*CLS**

Syntax: \*CLS

Description: **Clears status data.** Clears the following registers without affecting the corresponding Enable Registers: Standard Event Status Register (ESR), Operation Status Event Register, Questionable Status Event Register, and Status Byte Register (STB). Also clears the Error Queue.

### A.3 \*IDN? — IDENTIFICATION QUERY

**\*IDN?**

Syntax: \*IDN?  
Return value: Character string

Description: **Identifies the instrument.** This query requests identification. The power supply returns a string which contains the manufacturer name, the model, the serial number and the firmware level. The character string contains the following fields: <Manufacturer>, <Model>, <Serial Number>, <Firmware revision> where: <Manufacturer> = KEPCO, <Model> = KLN model number, <Serial Number> = SSSSSS <Firmware revision>=n.m, (e.g, 1.0).

### A.4 \*RST — RESET COMMAND

**\*RST**

Syntax: \*RST

Description: **Resets power supply to the power on default state.** The power supply output set to power-on default state.

After sending \*RST, output voltage is set to 0, output current is set to 0, OVP is set to rated voltage +10% and OCP is set to rated current +10%. It is recommended that this command is always the first command sent after remote digital control starts, to ensure that the output is set to zero and control of output on/off is properly enabled.

### A.5 \*TST? — SELF TEST QUERY

**\*TST?**

Syntax: \*TST?                      Returned value: 0 or 1

Description: **Power Supply test.** This query causes the power supply to do a self test and provide the controller with pass/fail results. A 0 is returned if the unit passes the test. A 1 is returned to indicate the unit failed self test.



## APPENDIX B - SCPI COMMAND/QUERY DEFINITIONS

### B.1 INTRODUCTION

This appendix defines the SCPI subsystem commands and queries used with the KLN power supply. Subsystem commands are defined in PAR. B.3 through B.62. Table B-1 provides a quick reference of all SCPI subsystem commands and queries used in the KLN 750W.

**TABLE B-1. SCPI SUBSYSTEM COMMAND/QUERY INDEX**

COMMAND	PAR.	COMMAND	PAR.
DISP:CONT, ?	B.3, B.4	SOUR:VOLT:LIM:LOW, ?	B.34, B.35
FETC?	B.5	SOUR:VOLT:PROT:LEV, ?	B.36, B.37
MEAS:ADDR?	B.6	SOUR:VOLT:PROT:TRIP?	B.38
MEAS:CURR?	B.7	SYST:BEEP, ?	B.39, B.40
MEAS:VOLT?	B.8	SYST:COMM:LAN:DHCP, ?	B.41, B.42
OUTP, ?	B.9, B.10	SYST:COMM:LAN:DNS, ?	B.43, B.44
OUTP:PON, ?	B.11, B.12	SYST:COMM:LAN:DNS:AUTO, ?	B.45, B.46
OUTP:PROT:CLE	B.13	SYST:COMM:LAN:GATE, ?	B.47, B.48
SOUR:CURR, ?	B.14, B.15	SYST:COMM:LAN:IP, ?	B.49, B.50
SOUR:CURR:PROT:LEV, ?	B.16, B.17	SYST:COMM:LAN:IPAD, ?	B.51, B.52
SOUR:CURR:PROT:STAT, ?	B.18, B.19	SYST:COMM:LAN:MAC?	B.53
SOUR:CURR:PROT:TRIP?	B.20	SYST:COMM:LAN:RES	B.54
SOUR:LIST:DTIM, ?	B.21, B.22	SYST:COMM:LAN:SMAS, ?	B.55, B.56
SOUR:LIST:RTIM, ?	B.23, B.24	SYST:COMM:LAN:TEL:PORT, ?	B.57, B.58
SOUR:MEM:CLS	B.25	SYST:ERR?	B.59
SOUR:MEM:CURR:X, ?	B.26, B.27	SYST:KLOC, ?	B.60, B.61
SOUR:MEM:LIST:X?	B.28	SYST:LOC	B.62
SOUR:MEM:REC:X	B.29	SYST:REM	B.63
SOUR:MEM:VOLT:X, ?	B.30, B.31	SYST:VERS?	B.64
SOUR:VOLT, ?	B.32, B.33		

NOTE: Commands listed above that are followed by ", ?" have a related query.

### B.2 NUMERICAL VALUES

<NR1> Refers to integer

<NRf> Refers to Floating (scientific notation: digits with decimal point and Exponent, e.g., 2.71E1 for 27.1.)

### B.3 DISP:CONTRast COMMAND

## DISP:CONT

Syntax:           Short Form: DISP:CONT <NR1>           Long Form: DISPlay:CONTRast <NR1>

Description:   **Sets the brightness of front panel Voltage and Current displays.**

Argument:       <NR1> is a value in the range from 0 to 5.

Example:         DISPlay:CONTRast 3 sets display contrast to level 3.

#### B.4 DISP:CONTRast? QUERY

### DISP:CONT?

Syntax: Short Form: DISP:CONT? Long Form: DISPlay:CONTRast  
Description: **Returns the brightness level set by DISP:CONT.**  
Return Format: <NR1>

#### B.5 FETCh? QUERY

### FETC?

Syntax: Short Form: FETC? Long Form: FETCh?  
Description: **Measures actual output voltage and current.** The query performs a measurement and returns the value of DC output current in amperes and DC output voltage in volts.  
Return Format: <NRf>  
Example: FETC? returns 1.41000E+01, 3.00100E-00 (current is 14.1A and voltage is 3.001V).

#### B.6 MEASure:ADDRess? QUERY

### MEAS:ADDR?

Syntax: Short Form: MEAS:ADDR? Long Form: MEASure:ADDRess?  
Description: **Returns the address of the KLN in a format compatible with active interface (either RS-485 or GPIB).** When output is OFF, output voltage and current are shown as:  
0.00000E+00,0.00000E+00 (0V, 0A).  
Return Format: <NR1>,<NRf+>,<NRf+>,<NRf+> equivalent to  
Address (preceded by "A" if RS 485), Output Voltage (volts), Output Current (amperes)  
Example: MEAS:ADDR? when using RS 485 with KLN 30-100 operating at rated output:  
returns A007,3.00000E+01,1.00000E+02,  
(address is 7, output voltage is 30V, output current is 100A  
MEAS:ADDR? when using GPIB with KLN 30-100 operating at rated output:  
returns 7,3.00000E+01,1.00000E+02  
(address is 7, output voltage is 30V, output current is 100A)

#### B.7 MEASure:CURRent? QUERY

### MEAS:CURR?

Syntax: Short Form: MEAS:CURR? Long Form: MEAS:CURRent?  
Description: **Returns 6 significant digits in floating format representing output current in amperes.** The number is two places more than shown on front panel Current display.  
Return Format: <NRf> (Current in amperes)  
Example: MEAS:CURR? returns 1.25024E+01 for output current of 12.5024A (front panel Current display shows 12.50).

#### B.8 MEASure:VOLTage? QUERY

### MEAS:VOLT?

Syntax: Short Form: MEAS:VOLT? Long Form: MEAS:VOLTage?  
Description: **Returns 6 significant digits in floating format representing output voltage in volts.** The number is two places more than shown on front panel Voltage display.  
Return Format: <NRf> (Voltage in volts)  
Example: MEAS:VOLT? returns 2.50057E+01 for output voltage of 25.0057V (front panel Voltage display shows 25.00).



## B.9 OUTPut COMMAND

## OUTP

- Syntax: Short Form: OUTP { ON | OFF| 1 | 0 } Long Form: OUTPut { ON | OFF| 1 | 0 }
- Description: **Enables or disables the power supply output.**  
To enable DC power supply output: <ON> or 1. To disable DC power supply output: <OFF> or 0.
- Argument: <ON> or 1 to enable power supply output  
<OFF> or 0 to disable power supply output
- Example: OUTP ON enables the DC output of the power supply.

## B.10 OUTPut? QUERY

## OUTP?

- Syntax: Short Form: OUTP? Long Form: OUTPut?
- Description: **Indicates whether power supply output is enabled or disabled.** Returns 0 if output disabled, returns 1 if output enabled.
- Return Format: { 1 | 0 }
- Example: OUTP? returns 1 (the DC output of the power supply is enabled).

## B.11 OUTPut:PON COMMAND

## OUTP:PON

- Syntax: Short Form: OUTP:PON { OFF| LAST } Long Form: OUTPut:PON { OFF| LAST }
- Description: **Determines power up status of output and operation of OUTP command after power up or recovery from mains loss.** When set to OFF (recommended), the power supply will power up with output off; output on/off can be controlled with OUTP command. When set to LAST (NOT recommended), the power supply will return to the output setting (on or off) in effect when power turned off or lost. If output was off, unit powers up with output off. If output was on, unit powers up with output on, however OUTP command can no longer turn the output off and \*RST is required to set output off.
- Argument: <OFF> Programs the unit to output off upon power up or recovery from mains loss.  
<LAST> Programs the unit to output on/off setting in effect just before the unit was turned off.
- Example: OUTP:PON OFF Programs the unit to output off state upon power up or recovery from mains loss and allows OUTP command to set output to on or off.

## B.12 OUTPut:PON? QUERY

## OUTP:PON?

- Syntax: Short Form: OUTP:PON? Long Form: OUTPut:PON?
- Description: **Indicates power up status of output and operation of OUTP command after power up or recovery from mains loss.** Returns OFF if unit set to power up with output disabled, returns LAST if unit set to power up with output set to setting in effect before unit was turned off
- Return Format: { OFF | LAST }
- Example: OUTP:PON? returns OFF (the unit will power up with output off).

## B.13 OUTPut:PROTection:CLEar COMMAND

## OUTP:PROT:CLE

- Syntax: Short Form: OUTP:PROT:CLE Long Form: OUTPut:PROTection:CLEar
- Description: **Clears the latched signals that have disabled the output.** Overvoltage and overcurrent conditions are always latched. if OUTPut:PON:STAtE is OFF, overtemperature and AC-fail conditions are latched; if OUTPut:PON:STAtE is LAST, overtemperature and AC-fail conditions are not latched. All conditions that generate the fault must be removed before the latch can be cleared. The output is then restored to the state it was in before the fault condition occurred.
- Argument: None.
- Example: OUTP:PROT:CLE clears the latched signals that have disabled the output.

#### B.14 SOURce:CURRent COMMAND

### SOUR:CURR

- Syntax: Short Form: SOUR:CURR <NRf> Long Form: SOURce:CURRent <NRf>
- Description: **Sets the output current value.** Maximum output current is rated current; minimum current is zero.
- Argument: <NRf> is a value in the range from 0 to rated current of unit. Rated voltage and current are defined by model (e.g., for KLN 6-100, rated voltage is 6V, rated current is 100A).
- Example: SOURce:CURRent 25 sets output current value to 25A.

#### B.15 SOURce:CURRent? QUERY

### SOUR:CURR?

- Syntax: Short Form: SOUR:CURR? Long Form: SOURce:CURRent?
- Description: **Indicates programmed output current (in amperes).**
- Return Format: <NRf>
- Example: SOURce:CURRent? returns 2.50000E+01 to indicate output current is programmed to 25A.

#### B.16 SOURce:CURRent:PROTection:LEVel COMMAND

### SOUR:CURR:PROT:LEV

- Syntax: Short Form: SOUR:VOLT:PROT:LEV <NRf>  
Long Form: SOURce:CURRent:PROTection:LEVel <NRf>
- Argument: <NRf> is a value in the range from 10% to 110% of rated current.  
MIN is the value programmed for output current (SOUR:CURR)  
MAX is 110% of rated current of unit
- Description: **Sets the overcurrent protection (OCP) value (in amperes).** OCP values set using this command are in effect once the unit is returned to local operation. Maximum value is 110% of rated voltage. MIN sets OCP to be the same as the value programmed for output current. \*RST sets SOUR:CURR:PROT:LEV to maximum value.
- Example: SOURce:CURRent:PROTection:LEVel 27.5 sets the overcurrent protection level to 27.5A. This is the maximum value if the unit is a 30V, 25A model. SOUR:CURR:PROT:LEV MIN sets the overcurrent protection level to be the same as the programmed value of output current (SOUR:CURR).

#### B.17 SOURce:CURRent:PROTection:LEVel? QUERY

### SOUR:CURR:PROT:LEV?

- Syntax: Short Form: SOUR:CURR:PROT:LEV? Long Form: SOURce:CURRent:PROTection:LEVel?
- Description: **Indicates programmed overcurrent protection (OCP) level for output current (in amperes).**
- Return Format: <NRf>
- Example: SOURce:CURRent:PROTection:LEVel? returns 2.75000E+01 to indicate overcurrent protection level is programmed to 27.5A.

#### B.18 SOURce:CURRent:PROTection:STATe COMMAND

### SOUR:CURR:PROT:STAT

- Syntax: Short Form: SOUR:VOLT:PROT:STAT <bool> {ON | OFF}  
Long Form: SOURce:CURRent:PROTection:STATe <bool> {ON | OFF}
- Argument: 1 or ON enables the foldback circuit for current protection  
0 or OFF disables the foldback circuit for current protection
- Description: **Controls whether the output Current Protection (OCP) foldback protection circuit is enabled.** The foldback protection circuit turns the output off if the power supply is operating in constant current mode and current exceeds the programmed value of SOUR:CURR:PROT:LEV for 0.5 Second.
- Example: SOUR:CURR:PROT:STAT 1 enables the foldback current protection

#### B.19 SOURce:CURRent:PROTection:STATe? QUERY

### SOUR:CURR:PROT:STAT?

- Syntax: Short Form: SOUR:CURR:PROT:STAT? Long Form: SOURce:CURRent:PROTection:STATe?
- Description: **Indicates state of overcurrent protection (OCP)**
- Return Format: <bool> 1 = enabled, 0 = disabled
- Example: SOUR:CURR:PROT:LEV? returns 0 to indicate OCP protection is disabled.

## **B.20 SOURce:CURRent:PROTection:TRIPped? QUERY SOUR:CURR:PROT:TRIP?**

Syntax: Short Form: SOUR:CURR:PROT:TRIP? Long Form: SOURce:CURRent:PROTection:TRIPped?  
Description: **Returns a 1 if the protection circuit is tripped and a 0 if it not tripped.**  
Return Format: <NRf>  
Example: SOURce:CURRent:PROTection:TRIPped? Returns 0 if OCP was not executed, 1 if OCP was executed.

## **B.21 SOURce:LIST:DTIME COMMAND SOUR:LIST:DTIM**

Syntax: Short Form: SOUR:LIST:DTIM <NRf> Long Form: SOURce:LIST:DTIME <NRf>  
Description: **Sets the output ramp-down time.**  
Argument: <NRf> is a value in the range from 0.0 to 9.9 seconds.  
Example: SOURce:LIST:DTIME 3.0 programs the output ramp-down time to 3.0 seconds.

## **B.22 SOURce:LIST:DTIME? QUERY SOUR:LIST:DTIM?**

Syntax: Short Form: SOUR:LIST:DTIM? Long Form: SOURce:LIST:DTIME?  
Description: **Indicates (in seconds) how long output voltage takes to reach zero from programmed value.**  
Return Format: <NRf>  
Example: SOURce:LIST:DTIME? returns 3.00000E+00 to indicate ramp-down time is 3.0 seconds.

## **B.23 SOURce:LIST:RTIME COMMAND SOUR:LIST:RTIM**

Syntax: Short Form: SOUR:LIST:RTIM <NRf> Long Form: SOURce:LIST:RTIME <NRf>  
Description: **Sets the output ramp-up time.**  
Argument: <NRf> is a value in the range from 0.0 to 9.9 seconds.  
Example: SOURce:LIST:RTIME 3.0 programs the output ramp-up time to 3.0 seconds.

## **B.24 SOURce:LIST:RTIME? QUERY SOUR:LIST:RTIM?**

Syntax: Short Form: SOUR:LIST:RTIM? Long Form: SOURce:LIST:RTIME?  
Description: **Indicates (in seconds) how long output voltage takes to reach programmed value.**  
Return Format: <NRf>  
Example: SOURce:LIST:RTIME? returns 3.00000E+00 to indicate ramp-up time is 3.0 seconds.

## **B.25 SOURce:MEMory:CLS COMMAND SOUR:MEM:CLS**

Syntax: Short Form: SOUR:MEM:CLS Long Form: SOURce:MEMory:CLS  
Description: **Clears all memory locations used for storing and recalling power supply settings.**  
Argument: None  
Example: SOURce:MEMory:CLS clears all memory locations.

## **B.26 SOURce:MEMory:CURRent:X COMMAND SOUR:MEM:CURR:X**

Syntax: Short Form: SOUR:MEM:CURR:X <NRf> Long Form: SOURce:MEMory:CURRent:X <NRf>  
Description: **Sets the memory location defined by X to the current value <NRf>.**  
Argument: <NRf> is a value in the range from 0 to rated current of unit.  
Example: SOURce:MEMory:CURRent:5 11.6 sets memory location 5 to 11.6A.

**B.27 SOURce:MEMory:CURRent:X? QUERY****SOUR:MEM:CURR:X?**

Syntax: Short Form: SOUR:MEM:CURR:X? Long Form: SOURce:MEMory:CURRent:X?

Description: **Returns current value stored in memory location X (in amperes).**

Return Format: <NRf>

Example: SOURce:MEMory:CURRent:5? returns 1.16000E+01 (Current stored in memory location 3 is 11.6A).

**B.28 SOURce:MEMory:LIST:X? QUERY****SOUR:MEM:LIST:X?**

Syntax: Short Form: SOUR:MEM:LIST:X? Long Form: SOURce:MEMory:LIST:X?

Description: **For the memory location defined by X, returns voltage (volts) and current (amperes) in scientific notation.**

Return Format: <NRf>

Example: SOURce:MEMory:LIST:3? returns 5.00000E+02, 2.50000E-00 (Voltage/Current stored in memory location 3 is 50V, 2.5A).

**B.29 SOURce:MEMory:RECall:X COMMAND****SOUR:MEM:REC:X**

Syntax: Short Form: SOUR:MEM:REC:X Long Form: SOURce:MEMory:RECall:X

Description: **Restores power supply settings to the voltage and current values stored in memory location defined by X.** If the output is off, the recalled voltage and current set values are shown on the front panel Voltage and Current displays. If the output is on, the output changes to the recalled voltage and current values which are also shown on the front panel Voltage and Current displays.

Argument: X is a number from 0 to 15 representing one of 16 memory locations

Example: SOURce:MEMory:RECall:3 sets power supply setpoints to 50V and 2.5A (values previously stored via either front panel or SOURce:MEMory:VOLTage:X and SOURce:MEMory:CURRent:X commands). If output is on, output is changed to 50V, 2.5A. If output is off, set values of 50V and 2.5A are displayed on the front panel.

**B.30 SOURce:MEMory:VOLTage:X COMMAND****SOUR:MEM:VOLT:X**

Syntax: Short Form: SOUR:MEM:VOLT:X <NRf> Long Form: SOURce:MEMory:VOLTage:X <NRf>

Description: **Sets the memory location defined by X to the voltage value <NRf>.**

Argument: <NRf> is a value in the range from 0 to rated voltage of unit.

Example: SOURce:MEMory:VOLTage:5 62.4 sets memory location 5 to 62.4V.

**B.31 SOURce:MEMory:VOLTage:X? QUERY****SOUR:MEM:VOLT:X?**

Syntax: Short Form: SOUR:MEM:VOLT:X? Long Form: SOURce:MEMory:VOLTage:X?

Description: **Returns voltage value stored in memory location X (in volts).**

Return Format: <NRf>

Example: SOURce:MEMory:VOLTage:5? returns 6.24000E+01 (Voltage stored in memory location 5 is 62.4V).

**B.32 SOURce:VOLTage COMMAND****SOUR:VOLT**

Syntax: Short Form: SOUR:VOLT <NRf> Long Form: SOURce:VOLTage <NRf>

Description: **Sets the output voltage value.** Maximum output voltage is 105% of rated voltage; minimum voltage is zero.

Argument: <NRf> is a value in the range from 0 to 105% of rated voltage of unit. Rated voltage and current are defined by model (e.g., for KLN 6-100, rated voltage is 6V, rated current is 100A).

Example: SOURce:VOLTage 30 sets output voltage value to 30V.

**B.33 SOURce:VOLTage? QUERY****SOUR:VOLT?**

Syntax: Short Form: SOUR:VOLT? Long Form: SOURce:VOLTage?  
 Description: **Indicates programmed output voltage (in volts).**  
 Return Format: <NRf>  
 Example: SOURce:VOLTage? returns 3.00000E+01 to indicate output voltage is programmed to 30V.

**B.34 SOURce:VOLTage:LIMit:LOW COMMAND****SOUR:VOLT:LIM:LOW**

Syntax: Short Form: SOUR:VOLT:LIM:LOW <NRf> { MIN | MAX }  
 Long Form: SOURce:VOLTage:LIMit:LOW <NRf> { MIN | MAX }  
 Argument: <NRf> is a value in the range from 0 to 95% of rated voltage of unit.  
 MIN is the minimum value for lower limit  
 MAX is the maximum value for lower limit  
 Description: **Sets the lower limit of output voltage (in volts).** The lower limit can be set to a maximum of 95% of rated voltage. Minimum value for lower limit is 0. \*RST sets this value to 0.  
 Example: SOURce:VOLTage:LIMit:LOW 10 sets lower limit for output voltage to 10V. For a 40V model this means that output voltage could not be programmed lower than 10V. SOURce:VOLTage:LIMit:LOW can program the lower limit for a 40V model only up to 38V (95% of 40V).

**B.35 SOURce:VOLTage:LIMit:LOW? QUERY****SOUR:VOLT:LIM:LOW?**

Syntax: Short Form: SOUR:VOLT:LIM:LOW? Long Form: SOURce:VOLTage:LIMit:LOW?  
 Description: **Indicates programmed lower limit for output voltage (in volts).**  
 Return Format: <NRf>  
 Example: SOURce:VOLTage:LIMit:LOW? returns 1.00000E+01 to indicate lower limit for output voltage is programmed to 10V.

**B.36 SOURce:VOLTage:PROTection:LEVel COMMAND****SOUR:VOLT:PROT:LEV**

Syntax: Short Form: SOUR:VOLT:PROT:LEV <NRf> { MIN | MAX }  
 Long Form: SOURce:VOLTage:PROTection:LEVel <NRf> { MIN | MAX }  
 Argument: <NRf> is a value in the range from 0% to 110% of rated voltage.  
 MIN is the value programmed for output voltage (SOUR:VOLT)  
 MAX is 110% of rated voltage of unit  
 Description: **Sets the overvoltage protection (OVP) value (in volts).** OVP values set using this command are in effect once the unit is returned to local operation. SOUR:VOLT:PROT:LEV MAX sets OVP to maximum value: 110% of rated voltage. SOUR:VOLT:PROT:LEV MIN sets OVP to the same value as programmed voltage (SOUR:VOLT). \*RST sets SOUR:VOLT:PROT:LEV to maximum value.  
 Example: SOURce:VOLTage:PROTection:LEVel 36 sets the overvoltage protection level to 36V. This is the maximum overvoltage protection value if the unit is a 30V model. SOUR:VOLT:PROT:LEV MIN sets OVP to the same value programmed for output voltage (SOUR:VOLT).

**B.37 SOURce:VOLTage:PROTection:LEVel? QUERY****SOUR:VOLT:PROT:LEV?**

Syntax: Short Form: SOUR:VOLT:PROT:LEV? Long Form: SOURce:VOLTage:PROTection:LEVel?  
 Description: **Indicates programmed lower limit for output voltage (in volts).**  
 Return Format: <NRf>  
 Example: SOURce:VOLTage:PROTection:LEVel? returns 4.40000E+01 to indicate overvoltage protection level is programmed to 44V.

### B.38 SOURce:VOLTage:PROTection:TRIPped? QUERY **SOUR:VOLT:PROT:TRIP?**

Syntax: Short Form: SOUR:VOLT:PROT:TRIP? Long Form: SOURce:VOLTage:PROTection:TRIPped?  
Description: **Returns a 1 if the protection circuit is tripped and a 0 if not tripped.**  
Return Format: <NRf>  
Example: SOURce:VOLTage:PROTection:TRIPped? Returns 0 if OVP was not executed, 1 if OVP was executed.

### B.39 SYSTem:BEEP COMMAND

### **SYST:BEEP**

Syntax: Short Form: SYST:BEEP { ON | OFF | 1 | 0 }  
Long Form: SYSTem:BEEP { ON | OFF | 1 | 0 }  
Description: **Sets the audible beep each time a front panel key is pressed to on or off.**  
Argument: <ON> or 1 enables audible beep  
<OFF> or 0 disables audible beep  
Example: SYSTem:BEEP 1 turns on the audible beep.

### B.40 SYSTem:BEEP? QUERY

### **SYST:BEEP?**

Syntax: Short Form: SYST:BEEP? Long Form: SYSTem:BEEP?  
Description: **Indicates whether audible beep is on or off.** Returns 1 to indicate the beep is on, 0 to indicate beep is off.  
Return Format: { 1 | 0 }  
Example: SYSTem:BEEP? returns 1 (audible beep is enabled).

### B.41 SYSTem:COMMunicate:LAN:DHCP COMMAND

### **SYST:COMM:LAN:DHCP**

Syntax: Short Form: SYST:COMM:LAN:DHCP { ON | OFF | 1 | 0 }  
Long Form: SYSTem:COMMunicate:LAN:DHCP { ON | OFF | 1 | 0 }  
Description: **Allows the IP address to either be assigned from the DHCP server (on) or assigned manually (static IP Address) by the user (off).** For E Suffix (LAN option) models only.  
Argument: <ON> or 1 enables DHCP  
<OFF> or 0 disables DHCP  
Example: SYST:COMM:LAN:DHCP ON assigns the DHCP server to assign the IP address.

### B.42 SYSTem:COMMunicate:LAN:DHCP? QUERY

### **SYST:COMM:LAN:DHCP?**

Syntax: Short Form: SYST:COMM:LAN:DHCP? Long Form: SYSTem:COMMunicate:LAN:DHCP?  
Description: **Indicates whether DHCP is on (enabled) or off (disabled).** Returns 1 to indicate the DHCP is on, 0 to indicate DHCP is off. For E Suffix (LAN option) models only.  
Return Format: { 1 | 0 }  
Example: SYST:COMM:LAN:DHCP? returns 1 (DHCP is enabled).

### B.43 SYSTem:COMMunicate:LAN:DNS COMMAND

### **SYST:COMM:LAN:DNS**

Syntax: Short Form: SYST:COMM:LAN:DNS "<address>"  
Long Form: SYSTem:COMMunicate:LAN:DNS "<address>"  
Description: **Used to set a static DNS address. This command is invalid when DHCP set to ON.** For E Suffix (LAN option) models only.  
Argument: "<address>" is text format in xxx.xxx.xxx.xxx  
Example: SYST:COMM:LAN:DNS "8.8.8.8" sets a DNS address to 8.8.8.8.

#### **B.44 SYSTem:COMMunicate:LAN:DNS? QUERY                    SYST:COMM:LAN:DNS?**

Syntax:            Short Form: SYST:COMM:LAN:DNS?    Long Form: SYSTem:COMMunicate:LAN:DNS?  
Description:       **Returns the DNS Address.** For E Suffix (LAN option) models only.  
Return Format:     "<address>" is text format in xxx.xxx.xxx.xxx  
Example:           SYST:COMM:LAN:DNS? returns DNS address "8.8.8.8".

#### **B.45 SYSTem:COMMunicate:LAN:DNS:AUTO COMMAND    SYST:COMM:LAN:DNS:AUTO**

Syntax:            Short Form: SYST:COMM:LAN:DNS:AUTO <bool> { ON | OFF | 1 | 0 }  
                     Long Form: SYSTem:COMMunicate:LAN:DNS:AUTO <bool> { ON | OFF | 1 | 0 }  
Description:       Used to enable the power supply to automatically obtain the DNS addresses from the DHCP server. **This command is invalid when DHCP set to ON.** For E Suffix (LAN option) models only.  
Argument:          <ON> or 1 enables automatic DNS addresses from DHCP  
                     <OFF> or 0 disables automatic DNS addresses from DHCP  
Example:           SYST:COMM:LAN:DNS:AUTO 1 enables DNS addresses to be obtained automatically from DHCP.

#### **B.46 SYSTem:COMMunicate:LAN:DNS:AUTO? QUERY    SYST:COMM:LAN:DNS:AUTO?**

Syntax:            Short Form: SYST:COMM:LAN:DNS:AUTO?  
                     Long Form: SYSTem:COMMunicate:LAN:DNS:AUTO?  
Description:       **Indicates whether automatic DNS addresses from DHCP is on (enabled) or off (disabled).** Returns 1 to indicate the automatic DNS addresses from DHCP is on, 0 to indicate automatic DNS addresses from DHCP is off. For E Suffix (LAN option) models only.  
Return Format:     { 1 | 0 }  
Example:           SYST:COMM:LAN:DNS? returns DNS address "8.8.8.8".

#### **B.47 SYSTem:COMMunicate:LAN:GATEway COMMAND    SYST:COMM:LAN:GATE**

Syntax:            Short Form: SYST:COMM:LAN:GATE <address>  
                     Long Form: SYSTem:COMMunicate:LAN:GATEway <address>  
Description:       **Sets a static default gateway address to be used during communication via the LAN interface.** This command is invalid if DHCP is enabled (on). For E Suffix (LAN option) models only.  
Argument:          <address> is text format xxx.xxx.xxx.xxx  
Example:           SYST:COMM:LAN:GATE 192.168.0.1 assigns the static default gateway address to be 192.168.0.1.

#### **B.48 SYSTem:COMMunicate:LAN:GATEway? QUERY    SYST:COMM:LAN:GATE?**

Syntax:            Short Form: SYST:COMM:LAN:GATE?    Long Form: SYSTem:COMMunicate:LAN:GATEway?  
Description:       **Indicates static default gateway address to be used during communication via the LAN interface.** For E Suffix (LAN option) models only.  
Return Format:     <address> is text format xxx.xxx.xxx.xxx  
Example:           SYST:COMM:LAN:GATE? returns 192.168.0.1 (static default gateway address).

#### **B.49 SYSTem:COMMunicate:LAN:IP COMMAND                    SYST:COMM:LAN:IP**

Syntax:            Short Form: SYST:COMM:LAN:IP <address>  
                     Long Form: SYSTem:COMMunicate:LAN:IP <address>  
Description:       **Sets the IP address for communication via the LAN interface.** Changing this address requires that power to the KLN be cycled off, then on. For E Suffix (LAN option) models only.  
Argument:          <address> is text in the format xxx.xxx.xxx.xxx  
Example:           SYST:COMM:LAN:IP 192.168.0.100 sets the IP address to 192.168.0.100.

**B.50 SYSTem:COMMunicate:LAN:IP? QUERY****SYST:COMM:LAN:IP?**

Syntax: Short Form: SYST:COMM:LAN:IP? Long Form: SYSTem:COMMunicate:LAN:IP?  
 Description: **Indicates IP address assigned for communication vi the LAN interface.** For E Suffix (LAN option) models only.  
 Return Format: <address> is text in the format xxx.xxx.xxx.xxx  
 Example: SYST:COMM:LAN:IP? returns 192.168.0.100 to indicate the IP address is set to 192.168.0.100.

**B.51 SYSTem:COMMunicate:LAN:IPADdress COMMAND****SYST:COMM:LAN:IPAD**

Syntax: Short Form: SYST:COMM:LAN:IPAD <address>  
 Long Form: SYSTem:COMMunicate:LAN:IPADdress <address>  
 Description: **Sets the static IP address for communication via the LAN interface.** Changing this address requires that power to the KLN be cycled off, then on. For E Suffix (LAN option) models only.  
 Argument: <address> is text in the format xxx.xxx.xxx.xxx  
 Example: SYST:COMM:LAN:IPAD 192.168.0.100 sets the static IP address to 192.168.0.100.

**B.52 SYSTem:COMMunicate:LAN:IPADdress? QUERY****SYST:COMM:LAN:IPAD?**

Syntax: Short Form: SYST:COMM:LAN:IPAD? Long Form: SYSTem:COMMunicate:LAN:IPADdress?  
 Description: **Indicates IP static address assigned for communication via the LAN interface.** For E Suffix (LAN option) models only.  
 Return Format: <address> is text in the format xxx.xxx.xxx.xxx  
 Example: SYST:COMM:LAN:IPAD? returns 192.168.0.100 to indicate the static IP address is set to 192.168.0.100.

**B.53 SYSTem:COMMunicate:LAN:MAC? QUERY****SYST:COMM:LAN:MAC?**

Syntax: Short Form: SYST:COMM:LAN:MAC? Long Form: SYSTem:COMMunicate:LAN:MAC?  
 Description: **Indicates MAC address assigned for communication via the LAN interface.** For E Suffix (LAN option) models only.  
 Return Format: <string> is text in the format xx-xx-xx-xx-xx-xx.  
 Example: SYST:COMM:LAN:MAC? returns 70-62-42-00-00-00 to indicate the MAC address is set to 70-62-42-00-00-00.

**B.54 SYSTem:COMMunicate:LAN:RESet COMMAND****SYST:COMM:LAN:RES**

Syntax: Short Form: SYST:COMM:LAN:RES  
 Long Form: SYSTem:COMMunicate:LAN:RESet  
 Description: **Resets the LAN settings used for communication via the LAN interface to the factory defaults.** This includes the IP address and hostname, so LAN communications could be lost. Factory default LAN settings are: DHCP set to On and IP address set to 192.168.0.100. For E Suffix (LAN option) models only.  
 Argument: none  
 Example: SYST:COMM:LAN:RES resets LAN settings to factor defaults described above.

**B.55 SYSTem:COMMunicate:LAN:SMAS COMMAND****SYST:COMM:LAN:SMAS**

Syntax: Short Form: SYST:COMM:LAN:SMAS <address>  
 Long Form: SYSTem:COMMunicate:LAN:SMAS <address>  
 Description: **Sets the Subnet Mask address for communication via the LAN interface.** Changing this address requires that power to the KLN be cycled off, then on. For E Suffix (LAN option) models only.  
 Argument: <address> is text in the format xxx.xxx.xxx.xxx  
 Example: SYST:COMM:LAN:SMAS 255.255.0.0 sets the Subnet Mask address to 255.255.0.0.



**B.56 SYSTem:COMMunicate:LAN:SMAS? QUERY                    SYST:COMM:LAN:SMAS?**

Syntax:                Short Form: SYST:COMM:LAN:SMAS? Long Form: SYSTem:COMMunicate:LAN:SMAS?  
 Description:        **Indicates Subnet Mask address assigned for communication via the LAN interface.** For E Suffix (LAN option) models only.  
 Return Format:      <address> is text in the format xxx.xxx.xxx.xxx  
 Example:            SYST:COMM:LAN:IP? returns 255.255.0.0 to indicate the Subnet Mask address is set to 255.255.0.0.

**B.57 SYSTem:COMMunicate:LAN:TELnet:PORT COMMAND       SYST:COMM:LAN:TEL:PORT**

Syntax:                Short Form: SYST:COMM:LAN:TEL:PORT <NR1>  
                           Long Form: SYSTem:COMMunicate:LAN:TELnet:PORT <NR1>  
 Description:        **Assigns port to be used for Telnet communication via the LAN interface.** KLN units use port 5025 for Telnet sessions. Changing this address requires that power to the KLN be cycled off, then on. For E Suffix (LAN option) models only.  
 Argument:           <NR1> in text format, a number from 0 to 65535  
 Example:            SYST:COMM:LAN:TEL:PORT 5025 assigns port 5025 to be used during Telnet sessions. A Telnet session can typically be started from a host computer shell by sending the IP address followed by the port number, e.g., telnet 192.168.0.100 5025.

**B.58 SYSTem:COMMunicate:LAN:TELnet:PORT? QUERY       SYST:COMM:LAN:TEL:PORT?**

Syntax:                Short Form: SYST:COMM:LAN:TEL:PORT?  
                           Long Form: SYSTem:COMMunicate:LAN:TELnet:PORT?  
 Description:        **Indicates port assigned for Telnet communication via the LAN interface.** For E Suffix (LAN option) models only.  
 Return Format:      <NR1> in text format, a number from 0 to 65535  
 Example:            SYST:COMM:LAN:TEL:PORT? returns 5025 to indicate port 5025 is assigned to be used during Telnet sessions.

**B.59 SYSTem:ERRor? QUERY    SYST:ERR?**

Syntax:                Short Form: SYST:ERR?    Long Form: SYSTem:ERRor?  
 Description:        **Returns error codes and messages.**  
 Return Format:      <string> is text format in -XXX XXXXXXXXXXXXXXX  
 Example:            Input command SOURce:VOLTage 2w will cause error. SYSTem:ERR? returns error code “-138,” and sending SYSTem:ERR? again returns no error code “+0,”. Refer to Table for a complete list of error codes.

**TABLE B-2. ERROR CODES**

Error Code	Explanation
0, “No error”	No error
72, “OVP”	Overvoltage protection error: a. The output voltage exceeds the OVP value. b. The Analog Programming input for output voltage setting is too high (higher than OVP value).
73, “OCP”	Output current exceeds 110% of rated current, this OCP value is restricted by hardware and not adjustable.
74, “REMOTE SENSE OVER”	The max. compensation voltage is 5V d-c (the sum of two wires, i.e. 2.5V d-c for each).
75, “D2D Module 1 fault”	DC to DC converter module number 1 failed (only one module in 750W models).
76, “D2D Module 2 fault”	DC to DC converter module number 2 failed (two modules in 1500W models).

**TABLE B-2. ERROR CODES (CONTINUED)**

77, “Analog shut-off shutdown”	a. The slave unit(s) failed when operating in parallel/series. b. Pins 23 and Pin 24 of Analog Programming Port are shorted to shut-off the output.
78, “Software OCP”	Software overcurrent protection error: The output current exceeds the set OCP value (adjustable manually or remotely) for more than 1 second.
79, “AC Fault”	Ac line input abnormal
83, “FAN failed”	One or more fan failed.
84, “D2D Module 3 fault”	DC to DC converter module number 3 failed (four modules in 3000W models).
85, “D2D Module 4 fault”	DC to DC converter module number 4 failed (four modules in 3000W models).
-102, “Syntax error”	An unrecognized command or data type was encountered; for example, a string was received when the device does not accept strings.
-104, “Data type error”	The parser recognized a data element different than one allowed; for example, numeric or string data was expected but block data was encountered.
-109, “Missing parameter”	Fewer parameters were received than required for the header; for example, the SYST:BEEP command requires one parameter, so SYST:BEEP is not allowed, while SYST:BEEP ON is allowed.
-221, “Settings conflict”	Indicates that a legal program data element was parsed but could not be executed due to the current device state
-222, “Data out of range”	Indicates that a legal program data element was parsed but could not be executed because the interpreted value was outside the legal range as defined by the device.
-223, “Too much data”	Indicates that a legal program data element of block, expression, or string type was received that contained more data than the device could handle due to memory or related device-specific requirements.
-224, “Illegal parameter valid”	Used where exact value was expected. from a list of possible values.
-241, “Hardware missing”	Indicates that a legal program command or query could not be executed because of missing device hardware; for example, an option was not installed.
-313, “Calibration memory lost”	Indicates that nonvolatile calibration data used by the *CAL? command has been lost.
-430, “Query Deadlocked”	Indicates that a condition causing an Deadlocked Query error occurred for example, both input buffer and output buffer are full and the device cannot continue.
-440, “Query Unterminated after indefinite response”	Indicates that a query was received in the same program message after a query requesting an indefinite response was executed
-500 OVP Setting too low	The OVP setting value is lower than output setting value. Error code generated but power unit remains in present condition.
-599, “IP conflict”	The desired IP address already exists on the network.

**B.60 SYSTem:KLOCk COMMAND**

**SYST:KLOC**

Syntax: Short Form: SYST:KLOC { ON | OFF | 1 | 0 } Long Form: SYSTem:KLOCk { ON | OFF | 1 | 0 }

Description: **Disables front panel keys and encoder.** Pressing SHIFT/LOC key on the front panel restores functionality to front panel keys and encoder

Argument: <ON> or 1 keys are locked.  
<OFF> or 0 key are unlocked.

Example: SYSTem:KLOCk 1 disables the front panel keys and encoder.

**B.61 SYSTem:KLOCk? QUERY**

**SYST:KLOC?**

Syntax: Short Form: SYST:KLOC? Long Form: SYSTem:KLOCk?

Description: **Indicates whether front panel keys and encoder are enabled or disabled.** Returns 1 to indicate keys are enabled, 0 to indicated keys are disabled.

Return Format: { 1 | 0 }

Example: SYSTem:KLOCK? returns 1 (front panel keys and encoder are unlocked).

**B.62 SYSTem:LOCAL COMMAND**

**SYST:LOC**

Syntax: Short Form: SYST:LOC Long Form: SYSTem:LOCAL

Description: **Sets the power supply to be in local mode.** The front panel [REMOTE] indicator goes off and the front panel keys and encoder are enabled.

Argument: None

Example: SYSTem:LOCAL puts the power supply in local mode.

**B.63 SYSTem:REMOTE COMMAND**

**SYST:REM**

Syntax: Short Form: SYST:REM Long Form: SYSTem:REMOTE

Description: **Sets the power supply to be in remote mode.** The front panel [REMOTE] indicator lights and the front panel keys and encoder are disabled. Pressing SHIFT/LOC key on the front panel restores the unit to local mode.

Argument: None

Example: SYSTem:REMOTE puts the power supply in remote mode.

**B.64 SYSTem:VERSION? QUERY**

**SYST:VERS?**

Syntax: Short Form: SYST:VERS? Long Form: SYSTem:VERSION?

Description: **Indicates the SCPI version to which unit complies.**

Return Format: <string> where <string> is text in XXXX.X format corresponding to SCPI year and revision.

Example: SYSTem:VERSION? returns 1990.0 (unit complies with SCPI version 1990.0.)

