

QUICK START GUIDE

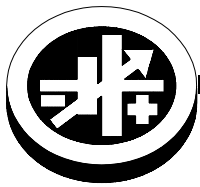

KEPCO An ISO 9001 Company.

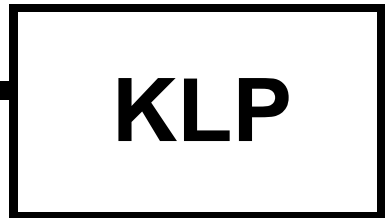

KLP POWER SUPPLY

This guide gives a brief introduction to the KLP Power supply, shows simple load connections, and allows you to verify the power supply is working. The guide also shows you how to use the front panel controls to perform the most commonly used functions.

Refer to the KLP User Manual for full specifications, installation considerations and operating instructions. An Installation/Operation Summary includes hyperlinked references to detailed procedure, but which can be printed as a handy reference.

Refer to the KLP Developer's Guide for a full description of the digital interfaces, their associated drivers, and the SCPI command language.

The User Manual, Developer's Guide, and drivers are found on the enclosed CD or can be downloaded from the Kepco web site at www.kepcopower.com/support/.

CONTENTS

DESCRIPTION.	2
UNPACKING.	2
EQUIPMENT SUPPLIED.	2
ACCESSORIES.	3
SAFETY.	3
PRELIMINARY OPERATIONAL CHECK.	4
INSTALLATION.	5
Input Connections.	5
Load Connections.	5
Local Sensing (Factory Default).	6
Remote Sensing Select.	6
Analog I/O Connections.	7
GPIB Connections.	7
RS 232 Connections (-1200 Models).	7
LAN Connections (-1.2K Models).	7
OPERATION.	7
Turning the Power Supply On.	7
Enabling/disabling Output Power.	8
Checking or changing Voltage/Current Setpoints.	8
Virtual Model Setting.	8
Setting voltage or current.	9
Last Setting Recall.	10
Viewing/Changing Overvoltage or Overcurrent Protection Values.	10
KLP OUTLINE DIMENSIONS	11

DESCRIPTION. The KLP Power Supply Series are universal input, automatic crossover, 1200-watt constant power, voltage/current stabilizers with a full rectangular output characteristic. There are six KLP -1200 Models and six KLP -1.2K Models (see Table 1). The KLP -1200 Models are GPIB and RS 232 compatible; the -1.2K Models are GPIB and LAN compatible; all models allow remote analog programming. For each model a multitude of virtual models can be configured. The “rated voltage, maximum current at rated voltage” and “rated current and maximum voltage at rated current” parameters define the virtual models available within the limit of 1200 Watts of output power.

TABLE 1. MODEL PARAMETERS

Model number	Rated Voltage Range ⁽¹⁾	Maximum current for rated voltage	Minimum programmable current	Rated Current Range ⁽¹⁾	Maximum voltage for rated current	Ripple and noise p-p ⁽²⁾	Efficiency @115 Va-c
KLP 10-150- ⁽³⁾	0-10V	120A@10V	3.2A	0-150A	8V@150A	75 mV	80%
KLP 20-120- ⁽³⁾	0-20V	60A@20V	1.6A	0-120A	10V@120A	75 mV	82%
KLP 36-60- ⁽³⁾	0-36V	33.3A@36V	0.8A	0-60A	20V@60A	125 mV	83%
KLP 75-33- ⁽³⁾	0-75V	16A@75V	0.4A	0-33.3A	36V@33.3A	125 mV	84%
KLP 150-16- ⁽³⁾	0-150V	8A@150V	0.2A	0-16A	75V@16A	125 mV	86%
KLP 300-8- ⁽³⁾	0-300V	4A@300V	0.1A	0-8A	150V@8A	300 mV	87%
KLP 600-4- ⁽³⁾	0-600V	2A@600V	0.05A	0-4A	300V@4A	400 mV	88%

(1) The maximum current and voltage are constrained by the 1200 watt power limitation.
(2) Bandwidth: 20MHz; low frequency ripple may be higher at loads less than 30 Watts.
(3) Specifications listed apply to both -1200 and -1.2K Models.

UNPACKING. This instrument has been thoroughly inspected and tested prior to packing and is ready for operation. After careful unpacking, inspect for shipping damage before attempting to operate. Perform the PRELIMINARY OPERATIONAL CHECK. If any indication of damage is found, file an immediate claim with the responsible transport service.

EQUIPMENT SUPPLIED. See Table 2.

TABLE 2. EQUIPMENT SUPPLIED

ITEM	PART NUMBER	QUANTITY
Source power connector	142-0381	1
Jumper (28 AWG or larger bus wire) for local sensing connections	172-0298	2
Analog I/O port mating connector	142-0528	1
Documentation CD (includes Documentation and Drivers)	254-0034	1

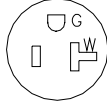
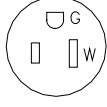
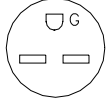

ACCESSORIES. See Table 3.

TABLE 3. ACCESSORIES

ITEM	FUNCTION		KEPCO PART NUMBER
Line Cord Set (125V/20A)	2.5m long cord set, provides for source power connection. Mates with NEMA 5-20R receptacle (see adjacent figure). Supports rated load power over mains voltage range of 90-136V a-c.	NEMA 5-20R 	118-0776
Line Cord Set (125V/15A)	2.5m long cord set, provides for source power connection. Mates with NEMA 5-15R receptacle (see adjacent figure). Supports restricted load power over mains voltage range of 90-136V a-c (contact Kepco Sales Engineering for details).	NEMA 5-15R 	118-1136
Line Cord Set (250V/15A)	2.5m long cord set, provides for source power connection. Mates with NEMA 6-15R receptacle (see adjacent figure). Supports rated load power over mains voltage range of 180-265V a-c.	NEMA 6-15R 	118-1137
IEEE 488 (GPIB) Cable, 1m long	Connect KLP Power Supply to GPIB bus.		SNC 488-1
IEEE 488 (GPIB) Cable, 2m long	Connect KLP Power Supply to GPIB bus.		SNC 488-2
IEEE 488 (GPIB) Cable, 4m long	Connect KLP Power Supply to GPIB bus.		SNC 488-4
Chassis Slide	Allows rack-mounted units to slide in and out. Two (2) slides required per power supply.		108-0239 (Jonathan 375-QD Series)
Analog Connector Backshell	Locks analog port mating connector to KLP via jackscrews.		108-0204
Loop Back Test Connector	Used for verification of RS 232 operation.		195-0112
Null Modem Cable	Connect RS 232 port with controlling computer, DB9F to DB9F, 10 ft long		118-1176
LAN Patch cable	Connects KLP LAN port to LAN, 10 ft long.		118-1115
Support bracket, rear	Provides extra support to rear of rack-mounted unit if needed. Two brackets required per unit. Each bracket requires 2 screws and 2 washers. See Figure 4, sheet 1, Detail "A" for requirements.		128-2306

SAFETY. See Table 4

TABLE 4. SAFETY SYMBOLS

SYMBOL	MEANING
	CAUTION: RISK OF ELECTRIC SHOCK.
	CAUTION: REFER TO REFERENCED PROCEDURE.
WARNING	INDICATES THE POSSIBILITY OF BODILY INJURY OR DEATH.
CAUTION	INDICATES THE POSSIBILITY OF EQUIPMENT DAMAGE.

PRELIMINARY OPERATIONAL CHECK. A simple operational check after unpacking and before equipment installation is advisable to ascertain whether the power supply has suffered damage resulting from shipping.

NOTE: This test must be performed with all I/O ports disconnected, and ANALOG I/O SETTINGS switch positions 3, 4 and 5 set to OFF (up).

- 1 With POWER circuit breaker set to OFF position, connect the power supply to source power (see See "Input Connections." on page 5.).
- 2 With no load connected, set POWER circuit breaker to the ON position. Each time the unit is turned on an internal self-test is performed (see "Turning The Power Supply On." on page 7). After the test has been successfully completed, the status display reads SET (setpoint mode), the DC VOLTS display reads 0 Volts and the DC AMPERES display reads minimum Amperes (see Note 1, below).

NOTES: 1. A minimum programmed current (actual value depends on model) is required to ensure proper operation of the power supply under all load conditions. Programmed current is automatically set to be at least the minimum current.

2. If an error indication is blinking in the Status display, refer to User Manual for an explanation of error codes.

- 3 Rotate VOLTAGE adjust knob clockwise. Verify that DC VOLTS display increases in large (X 100) increments.
- 4 Press and rotate VOLTAGE adjust knob clockwise. Verify the DC VOLTS display increases in finer increments than step 3, then release knob.
- 5 Adjust VOLTAGE adjust knob clockwise until Status display reads >MAX. Tap either VOLTAGE or CURRENT adjust knob once to enter values. Verify Status display is blank
- 6 Connect a digital voltmeter (DVM) to the (M+) and (M-) terminals on the rear panel.
- 7 Press and release DC OUTPUT switch to enable the output. Verify DC OUTPUT indicator lights.
- 8 Compare the programmed output voltage value (step 5) with the voltage reading of the DVM; the difference between the two should not exceed 0.05% of the maximum voltage of the unit.
- 9 Compare the voltage reading of the DC VOLTS display with that of the DVM; the difference between the two should not exceed 0.1% of the maximum voltage of the unit.
- 10 Enter different value for output voltage, then repeat steps 4 and 5 using different values for programmed voltage.
- 11 Disable the output by pressing and releasing DC OUTPUT switch; verify front panel DC VOLTS and DC AMPERES displays read 0.0V and minimal current and the DC OUTPUT indicator is off.
- 12 Set POWER ON/OFF circuit breaker to OFF and disconnect from source power, load and test equipment.

INSTALLATION. Install units in a 19 inch-wide rack. Optional slides may be used. Leave the front and rear panels clear of obstructions to ensure adequate cooling. For parallel, series and master-slave configurations, refer to the User Manual.

INPUT CONNECTIONS. Wire the mating source power connector provided (142-0381) for your input mains (see Table 5 for mains voltage range). The user must provide a properly sized and rated mains lead (line cord) and service with a current rating compatible with the anticipated input current. Line cords available as accessories are listed in Table 3. Plug the source power connector into the source power inlet connector at the rear panel.

TABLE 5. INPUT CURRENT SERVICE RATING AND CONDUCTOR SIZES

MAINS VOLTAGE RANGE	CURRENT SERVICE RATING	CONDUCTOR SIZE
100 - 132V a-c, 50/60Hz	20 Amp	#12AWG [2,0 mm ²]
180 - 265V a-c, 50/60Hz	15 Amp	#14AWG [3,0 mm ²]

LOAD CONNECTIONS. Connect the load to the (+) and (–) DC OUTPUT terminals on the rear panel (Figure 2). (+M) and (–M) outputs are for connection of external monitoring equipment such as a DVM, oscilloscope, etc.

Configuration of local sensing is facilitated by pre-installed jumpers which configure the unit for local sensing, as shown in Figure 2.

NOTE: Output Sense lines must be connected for proper operation, either locally, or at the load (remote).

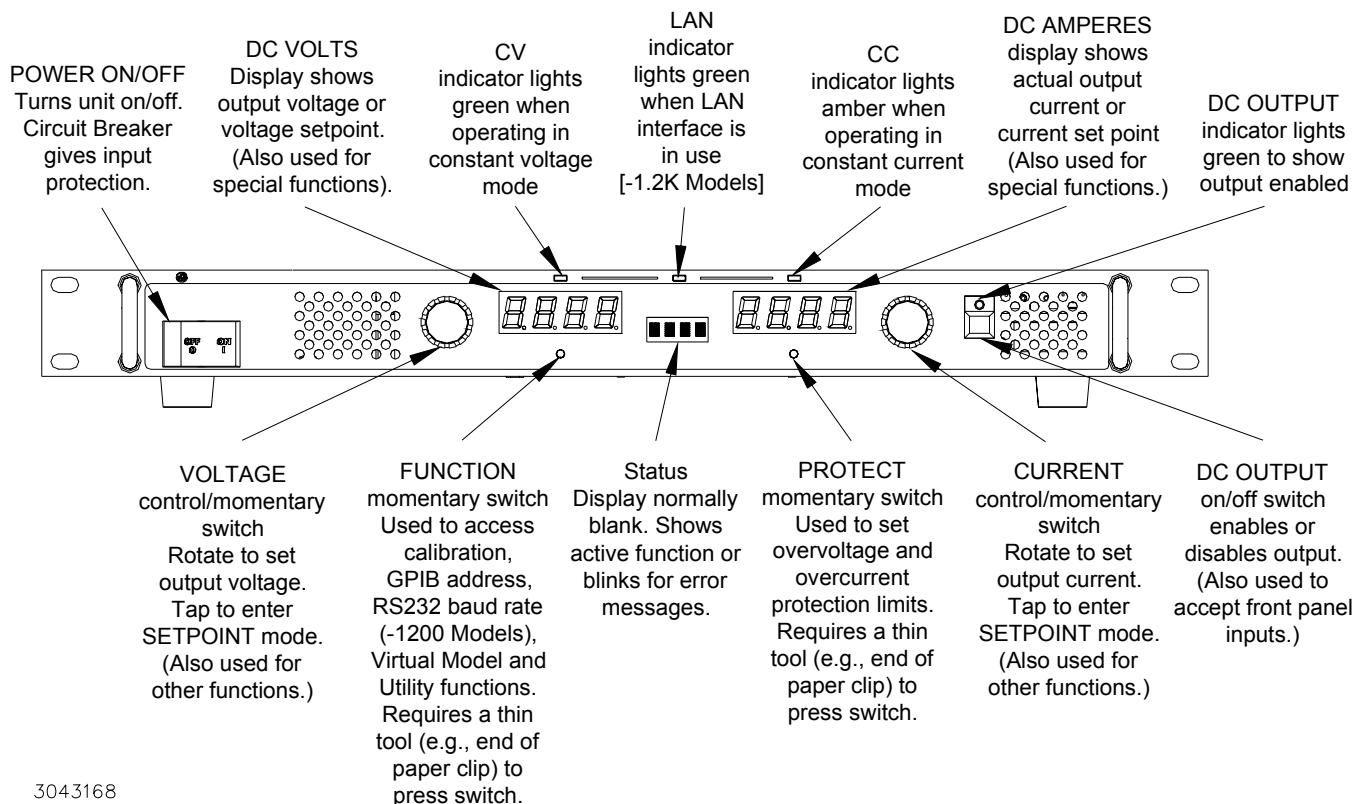

FIGURE 1. KLP SERIES, FRONT PANEL CONTROLS AND INDICATORS

LOCAL SENSING (FACTORY DEFAULT). Unit is shipped with local sensing jumpers installed: +S connected to +M and -M connected to -S (see Figure 2).

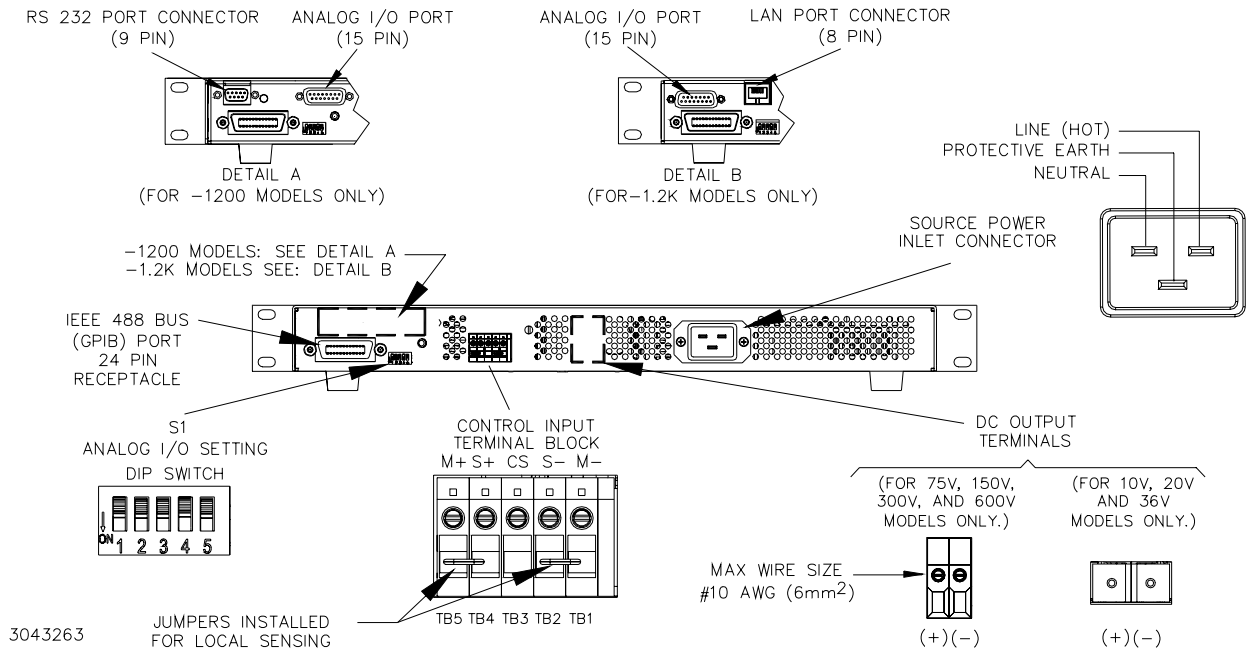

FIGURE 2. KLP SERIES, REAR PANEL VIEW, JUMPERS INSTALLED FOR LOCAL SENSING

REMOTE SENSING SELECT. First remove the factory-installed local sensing jumpers between +S and +M and between -M and -S. Then connect the +S and -S lines at the load, observing proper polarity (see Figure 3). A high frequency bypass network consisting of two capacitors connected across the error sensing point as shown in Figure 3 is recommended to reduce noise in the sense loop.

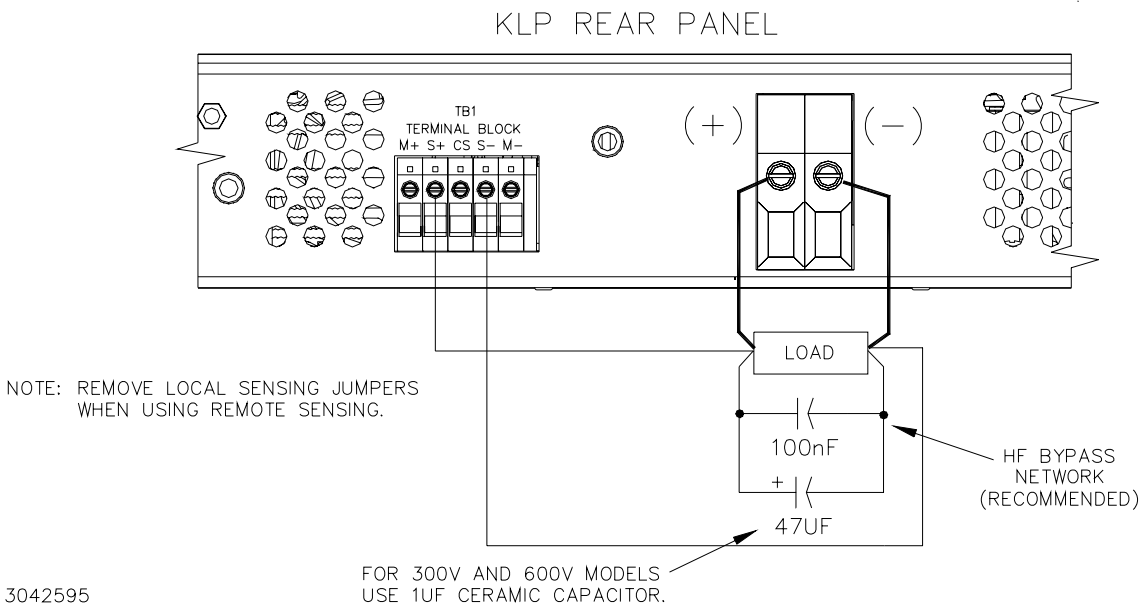

FIGURE 3. REMOTE SENSING

ANALOG I/O CONNECTIONS. The Analog I/O Port connector, located on the rear panel of the KLP power supply (see Figure 2), provides access to analog programming inputs, status signal outputs and an external trigger input available for use with SCPI *TRG and TRIG commands.

GPIB CONNECTIONS. Your computer must have a GPIB interface card installed. Connect the power supply to the computer's GPIB interface card. Use a standard GPIB interface cable at the GPIB port on the rear panel (see Figure 2). The default GPIB address is 6. Refer to the User manual to change it from the front panel, or to the Developer's Guide to change it using SCPI commands.

RS 232 CONNECTIONS (-1200 MODELS). Connect the KLP to a modem using a Null Modem patch cable at the RS 232 port located on the rear panel (See Figure 2). A Null Modem cable is not required for older MAC computers with D-sub serial port in which the RXD and TXD line transposition is accomplished via external hardware. The default baud rate is 38400. Refer to the User manual to change it from the front panel, or to the Developer's Guide to change it using SCPI commands.

LAN CONNECTIONS (-1.2K MODELS). The LAN interface allows the KLP to communicate via a built-in web port (using web pages from a standard browser), as well as through other built-in LAN ports. Connect the KLP to the LAN via the RJ 45 LAN port located at the rear panel (See Figure 2). Refer to the User manual to configure the LAN interface from the front panel or through the web interface. Refer to the Developer's Guide for the associated SCPI commands

OPERATION. Additional features covered in the User Manual are: Quick Boot (eliminating the power-up displays), use of the internal relay, and operation via the LAN interface or analog signals. An Installation/Operation Summary is also included in the User manual. The Developer's Guide covers the GPIB and RS 232 and LAN interfaces, including the use of the drivers supplied on the CD.

TURNING THE POWER SUPPLY ON. To turn the power supply on, set POWER ON/OFF circuit breaker (Figure 1) to ON. If an error occurs, an error code is displayed in the status display (see User Manual.)

- 1 When the power supply is turned on, it performs a self-test and displays the following information:
 - Status display flashes MODL for 2 seconds while DC VOLTS and DC AMPERES displays show the maximum voltage and current capability of the unit.
 - Status display flashes VIRT for 2 seconds while DC VOLTS and DC AMPERES displays show the maximum voltage and current allowed for a previously programmed virtual model.
 - Status display flashes PROT for 2 seconds while DC VOLTS and DC AMPERES displays show previously stored OVP and OCP trigger levels.
 - For -1.2K Models, the LAN indicator blinks rapidly during initialization while looking for an IP address. The LAN indicator stays on if an IP address is found and stays off if not found.
- 2 After a successful self test, the default conditions upon power up are as follows:
 - Status display shows SET,
 - Output is disabled (green DC OUTPUT indicator is off).
 - DC VOLTS and DC AMPERES displays show programmed output conditions: 0 Volts, minimum Amperes (if DIP switch position 3 was ON when the unit was turned off, previously saved setpoint values are displayed).

NOTE: A minimum programmed current is required to ensure proper operation of the power supply under all load conditions. Programmed current is automatically set to be at least the minimum current (actual value depends on model, see Table 1).

- Since the output is off, Constant Voltage (CV) mode indicator (green LED) and Constant Current (CC) indicator (amber LED) are off.

ENABLING/DISABLING OUTPUT POWER. When the power supply is turned on, the output is automatically disabled (DC OUTPUT LED is off), the DC VOLTS and DC AMPERES displays show the programmed output voltage and current set points and “SET” appears in the status display.

- 1 To enable the output, first exit SET mode by tapping either the VOLTAGE or CURRENT control, then press and release the DC OUTPUT switch. The associated green LED lights to indicate output power is applied to the load. Each time you exit SET mode, the setpoint values are stored for possible recall if the power supply is turned off or the output is disabled.
- 2 To disable the output, press and release the DC OUTPUT switch again. The DC OUTPUT indicator goes off.

NOTE: While in the setpoint mode (Status display reads SET) the output cannot be turned on (pressing DC OUTPUT has no effect). If output was on while setpoint mode was entered, pressing DC OUTPUT will disable the output.

CHECKING OR CHANGING VOLTAGE/CURRENT SETPOINTS.

CAUTION: When the output is disabled, the DC VOLTS and DC AMPERES displays show the actual output voltage and current. Before enabling the output ALWAYS check the setpoints to avoid possible damage to the load.

- 1 Tap either the VOLTAGE or CURRENT control. The status display reads SET, and the DC VOLTS and DC AMPERES displays show the stored setpoints.
- 2 To accept the displayed value, tap the associated adjustment control again. To change the value, rotate the control (press the control in while rotating for fine adjustment), then tap the adjustment control again to accept the new setting.

NOTE: Before changing the setpoint, note the displayed setpoint. If you decide not to change the value after rotating the control, you must rotate the control to the value noted, then tap the adjustment control to accept.

VIRTUAL MODEL SETTING. The virtual model establishes a maximum programmable voltage and current for the unit within the 1200W power limitation and the maximum voltage and current ratings listed in Table 1. The unit will not accept programmed values beyond these values.

- 1 Using a thin tool (e.g., a paper clip), press the FUNCTION switch once so that the status display reads VIRT. The DC VOLTS and DC AMPERES displays show the programmed maximum voltage and current of the virtual model.
- 2 To exit, rotate either VOLTAGE or CURRENT control until Status display reads EXIT, then tap DC OUTPUT switch. To change the virtual model limits refer to the User Manual.

SETTING VOLTAGE OR CURRENT. The VOLTAGE and CURRENT controls adjust output voltage and current limit, respectively, when the unit is in constant voltage (CV) mode and adjust voltage limit and output current, respectively, when the unit is in constant current (CC) mode. The mode (CV or CC) is determined by the load together with the programmed settings. As long as the voltage across the load produces a current that is less than the programmed Current setpoint, the unit operates in CV mode (voltage programmed to voltage setpoint, current limited by current setpoint). If the load changes to the point that current through the load reaches the current setpoint, the unit automatically enters CC mode (current programmed to current setpoint, voltage limited by voltage setpoint).

Output voltage or current can be set at the front panel in two ways: Real-time adjustment or Setpoint adjustment.

Real-time Voltage/Current Adjustment. Rotating the associated control will change the output voltage or current in real-time only if the output is enabled. If the unit is in constant voltage mode (CV indicator lit) the DC VOLTS display shows the actual output voltage as the VOLTAGE control is rotated. Similarly, if the unit is in constant current mode (CC indicator lit) the DC AMPERES display shows the actual output current as the CURRENT control is rotated.

- If the unit is in CV mode, rotating the CURRENT control will affect the current limit even though the DC AMPERES display does not change since it is showing actual output current. Similarly, rotating the VOLTAGE control while in CC mode affects the voltage limit. To change the limits to a precise value, refer to SETPOINT ADJUSTMENT.
- Voltage and current settings are not allowed to exceed either a) the virtual model setting or b) 80% of the protection value. Attempts to set voltage or current beyond these limits will not be accepted. The status display shows either >MAX for virtual model, >OVP for voltage protection, or >OCP for current protection to indicate which limit is being exceeded.

Setpoint Voltage/Current Adjustment.

- 1 Tap either the VOLTAGE or CURRENT control to initiate setpoint adjustment (status display reads SET). The previous setpoint is visible on the corresponding DC VOLTS or DC AMPERES display.
- 2 Rotate the corresponding control to change the setpoint as viewed on the corresponding LED display. Tap the adjustment control again to accept the new setting.
 - In the setpoint mode, both coarse (rotate the control) and fine (rotate while pressing control in) adjustment is available. The coarse adjustment is approximately 100X the fine adjustment resolution.
 - Setpoint adjust can be done with output either on or off, however the output can not be enabled while setpoint is active.
 - Voltage and current settings are not allowed to exceed either a) the virtual model setting or b) 80% of the protection value. Attempts to set voltage or current beyond these limits will not be accepted. The status display shows either >MAX for virtual model, >OVP for voltage protection, or >OCP for current protection to indicate which limit is being exceeded.
 - If you decide not to change the value after rotating the control, the previous setpoint value will be restored after about 20 seconds of inactivity. Then tap either adjustment control to accept.

LAST SETTING RECALL. KLP is capable of saving the last setpoint values for voltage and current prior to unit shutdown, and recalling them when the unit is next turned on. Enable this function prior to power-up by setting Analog I/O Switch 3 to the ON (down) position (see Figure 2). Upon next power-up, each setpoint entry for voltage and current is stored in non-volatile memory, with latest settings displacing prior ones. When the power supply is turned off, the last settings are saved and automatically retrieved at next power-up as the starting setpoints.

- Recall is for SETPOINT ADJUSTMENTS only; output changes entered as REALTIME ADJUSTMENTS are not saved.
- To disable this function, turn the unit off and set Analog I/O Switch 3 to the OFF (up) position. At next power-up, the stored value buffer is cleared and setpoints will default to zero volts and minimum current.
- If the virtual model for the power supply is altered, the last settings are reset to zero volts and minimum current.

VIEWING/CHANGING OVERVOLTAGE OR OVERCURRENT PROTECTION VALUES.

Overvoltage and Overcurrent protection values can be individually programmed. The range for overvoltage and overcurrent values are 0.2 to $1.2 \times E_{Omax}$ and 0.72 to $1.2 \times I_{Omax}$.

If the output voltage/current exceeds the overvoltage/overcurrent protection value, the protection circuit latches the output off, flashes an overvoltage (OVP) or overcurrent (OCP) protection error message on the status display and sets a status bit that can be retrieved through the RS 232, GPIB or LAN port. The unit must be cycled on and off to restore the output.

- The maximum values are $1.2 \times E_{Omax}$ for overvoltage protection, and $1.2 \times I_{Omax}$ for overcurrent protection.
 - A built-in feature prevents the unit from being programmed within 20% of OVP or 20% of OVC (or the minimum OVC which is 72% of I_{Omax}). For example, if OVP and OVC are set to 12V and 72A, respectively, programming of the output is automatically limited to 10V and 60A.
 - When a virtual model is defined, OVP and OVC are automatically set 20% and 20%, respectively, above the maximum programmable values established by the virtual model. If OVP or OVC are lowered by the user, valid settings will actually be lower than the virtual model limits because values within 20% of OVP or 20% of OVC are prohibited.
 - If either adjustment exceeds maximum programmable volts or amps, or if the adjustment is within 20% of OVP or 20% of OCP, the status display will show >MAX.
- 1 Using a thin tool (e.g., end of paper clip), press and hold the PROTECT switch. The output is switched off, setting voltage to zero Volts, and current to a minimal value, and the status display shows PROT. The DC VOLTS and DC AMPERES displays show the corresponding overvoltage and overcurrent protection setpoints while the PROTECT switch is held in.
 - 2 To change the values, operate the corresponding adjustment control while holding the PROTECT switch in. When the PROTECT switch is released, the protection values showing in the DC VOLTS and DC AMPERES displays are entered as the new protection values.

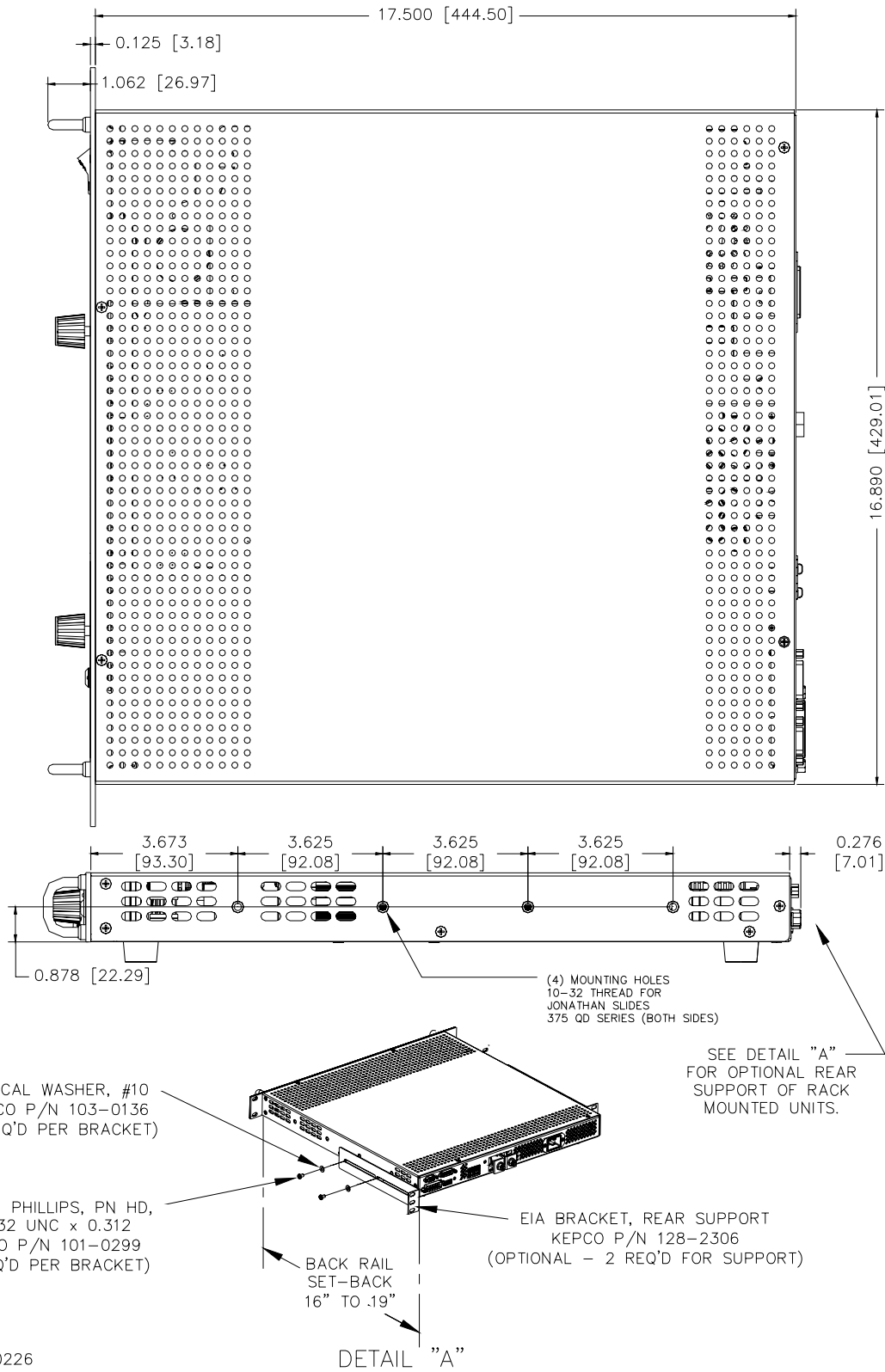
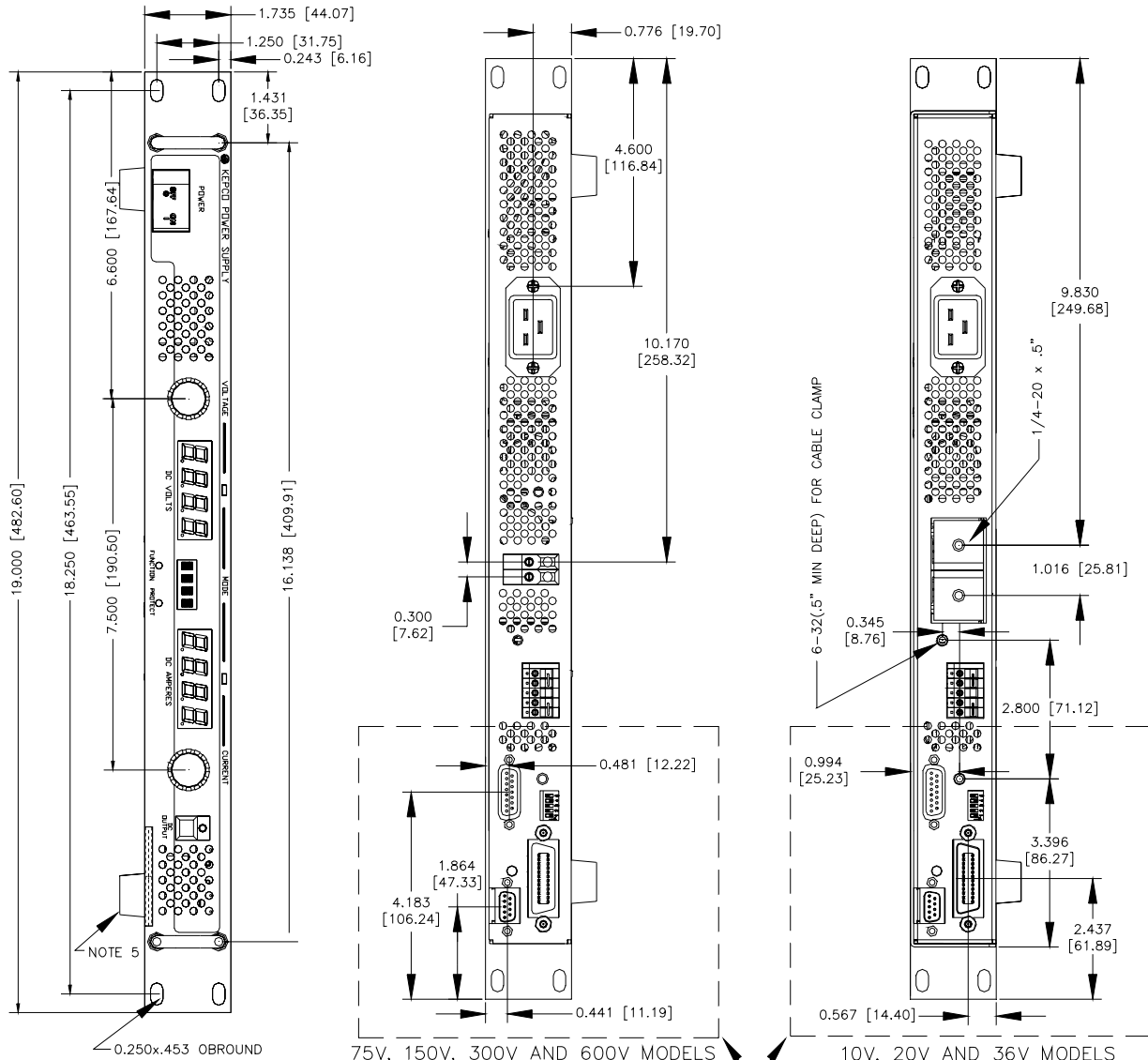
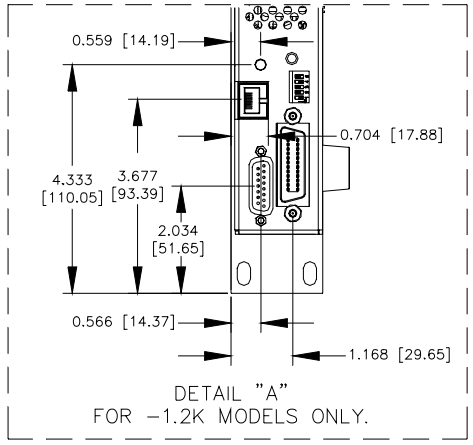

FIGURE 4. KLP OUTLINE DIMENSIONS (SHEET 1 OF 2)



- NOTES:
- MATERIAL:
 - CHASSIS: 0.064 THK. ALUM. 5052-H32
 - COVER: 0.064 THK. ALUM. 5052-H32
 - FRONT PANEL: 0.125 THK. ALUM. 6061-T6
 - FINISH:
 - CHASSIS, COVER AND BACKPLATE: YELLOW IRIDITE
 - FRONT PANEL: KEPKO GREY,
 - DIMENSIONS IN PARENTHESES ARE IN MILLIMETERS.
 - TOLERANCES:
 - BETWEEN MOUNTING HOLES: $\pm 1/64$ (± 0.4).
 - ALL OTHER DIMENSIONS: $\pm 1/32$ (± 0.8) EXCEPT AS NOTED.
 - REMOVE 4 PLASTIC FEET BEFORE RACK INSTALLATION
 CAUTION: IF REINSTALLATION OF FEET IS NECESSARY, FAILURE TO REINSTALL FEET USING ALL HARDWARE SPECIFIED OR LONGER SCREW CAN RESULT IN DAMAGE TO THE UNIT.
 SCREW: 6-32 X 0.50 IN. (MAX), BHPH (P/N 101-0019)
 LOCKWASHER, #6, 0.018 IN. THK (P/N 103-0015)
 FLAT WASHER, #6, 0.028 IN. THK (P/N 103-0100)



3010226

FIGURE 4. KLP OUTLINE DIMENSIONS (SHEET 2 OF 2)

You must register your product to comply with the terms of the warranty. Either fill out the form below and mail or fax to Kepco, or for rapid on-line registration go to:

<http://www.kepcopower.com/warranty.htm>

PRODUCT PURCHASED:

Model Number) _____

Serial Number _____

PURCHASE INFORMATION:

Date Purchased: _____

Date Received: _____

REQUEST ADDITIONAL INFORMATION

Send complete Catalog

Have Sales Engineer Call

Contact via: E-Mail Telephone Fax S-mail

REGISTER TO:

Registered by: _____

Company Name: _____

Street: _____

City: _____

State: _____

Country: _____

Zip: _____

E-mail: _____

FAX: _____

Phone: _____

WHAT INFLUENCED YOUR CHOICE OF THIS POWER SUPPLY?

Previous Experience (which Kepco Models do you have?) _____

Magazines (which ones?) _____

Trade Shows (which ones?) _____

Directory? _____

Kepco Catalog or Brochure? _____

Sales Representative?

Web Site

Other (please explain): _____

What products would you like to see Kepco make?

CUT HERE

Kepco 5 Year Warranty

This is to certify that we, KEPCO, INC., (hereinafter called "Company"), Flushing, NY 11355 USA, warrants for a period of FIVE YEARS, this instrument known as:

MODEL: _____

SERIAL NO. _____

The Company's products are warranted for a period of five years from date of delivery to be free from defects in materials and workmanship and to conform to the specifications furnished or approved by the Company. Liability under this warranty shall be limited to the repair or replacement of any defective product at Company's option.

If any defect within this warranty appears within the warranty period, the Purchaser shall promptly notify the Company in writing. No material will be accepted for repair or replacement without written authorization of the Company.

Upon such authorization, and in accordance with instructions of the Company, parts or materials for which replacement is requested shall be returned to the Company for examination, with shipping charges prepaid by the Purchaser. Final determination as to whether a product is actually defective rests with the Company.

This warranty does not extend to any product which has been subjected to misuse, neglect, accident, improper installation, or use in violation of instructions furnished by the Company. The warranty does not extend to, or apply to, any unit which has been repaired or altered outside of the Company's factory by persons not expressly approved by the Company.

THE WARRANTY HEREIN CONTAINED IS IN LIEU OF AND EXCLUDES ALL OTHER WARRANTIES, EXPRESS, IMPLIED OR STATUTORY, INCLUDING WITHOUT LIMITATION THE WARRANTY OF MERCHANTABILITY.

THIS KEPCO PRODUCT IS WARRANTED FOR FIVE YEARS!

KEPCO, INC. • 131-38 SANFORD AVENUE, FLUSHING, NY 11355 USA • Tel. 718-461-7000 • Fax. 718-767-1102
E-mail: hq@kepcopower.com • URL: <http://www.kepcopower.com>



FOLD HERE

Please
place
stamp
here

KEPCO, INC.

131-38 SANFORD AVE.
FLUSHING, NY 11355 USA

CUT HERE