



Features :

- Universal AC input active PFC
- Protections: Short circuit / Over load / Over voltage / Over Temp.
- All using 105°C long life electrolytic capacitors
- High operation temperature up to 60°C
- Active AC surge current limiting
- Power OK signal
- U-bracket low profile: 38mm
- Free air convection for 400W and 500W with 23.5CFM forced air
- A DC fan supply is provided
- High power density 6.4w/in³
- Remoter Voltage sense
- 2 modes Remoter ON/OFF Ctrl. Setup by user
- Withstand 2G vibration test
- High efficiency, long life and high reliability
- 3 years warranty



MODEL		UP-500-12	UP-500-15	UP-500-24	UP-500-48
Output	DC Voltage Range	12V	15V	24V	48V
	Rated Current	42A	33.5A	21A	10.5A
	Current Range (convection)	0 ~ 33.3A	0 ~ 26.7A	0 ~ 16.7A	0 ~ 8.4A
	Rated Power (23.5CFM FAN)	0 ~ 42A	0 ~ 33.5A	0 ~ 21A	0 ~ 10.5A
	Rated Power (convection)	399.6W	400.5W	400.8W	403.2W
	Rated Power (23.5CFM FAN)	504W	502.5W	504W	504W
	Ripple & Noise (max.) <small>Note.2</small>	150 mVp-p	150 mVp-p	150 mVp-p	150 mVp-p
	Voltage Adj. Range	10.8 ~ 13.2V	13.5 ~ 16.5V	21.6 ~ 26.4V	43.2 ~ 52.8V
	Voltage Tolerance <small>Note.3</small>	±2%	±2%	±2%	±2%
	Line Regulation	±1%	±1%	±1%	±1%
	Load Regulation	±2%	±2%	±2%	±2%
Setup, Rise Time	600ms, 30ms at full load				
Hold Up Time (Typ.)	16ms / 230VAC at full load				
Input	Voltage Range <small>Note.4</small>	90 ~ 264VAC	127 ~ 370VDC		
	Frequency Range	47 ~ 63Hz			
	Efficiency (Typ.)	90%	90%	90%	91%
	AC Current (Typ.)	6 A / 115VAC	3A / 230VAC		
	Inrush Current (Typ.)	30A / 115VAC 50A / 230VAC			
Leakage Current	< 2mA / 230VAC				
Protection	Over Load	> 105% rated output power Protection type : constant current limiting, output voltage less than 50% rating DC voltage range after 500ms the unit will shutdown			
	Over Voltage	115% ~ 150% rated output voltage Protection type : latch-off mode, re-power on to recover			
	Over Temperature	95°C With N2 sense by T1 core ±5°C, 95°C With TH1 sense near D26 heat sink ±5°C			
Environment	Working Temp.	-20°C ~ +60°C (Refer to output load de-rating curve)			
	Working Humidity	20 ~ 90% RH non-condensing			
	Storage Temp., Humidity	-40 ~ +85°C, 10 ~ 95% R.H			
	Temp. Coefficient	±0.03%/°C (0 ~ 50°C)			
Safety & EMC <small>Note.5</small>	Vibration	10 ~ 500Hz, 2G 10min./1 cycle, period for 60 min. Each along X,Y,Z axes			
	Safety Standards	UL 60950-1, 2 nd Edition, TUV EN60950-1 : 2006+A11 Approved			
	Withstand Voltage	I/P - O/P : 4242 DC I/P - FG : 2121 DC 1 minute			
	Isolation Resistance	I/P - O/P, I/P - FG, O/P - FG: 100M Ω / 500VDC			
	EMI Conduction & Radiation	EN55022: 2006 Class B			
	Harmonic Current	EN61000-3-2: 2006 Class A, EN61000-3-3: 1995+A1: 2001+A2: 2005			
EMS Immunity	EN61204-3: 2000, EN55024: 1998+A1: 2001+A2: 2003 light industry level, criteria A				
Others	Connection	I/P 3P / 9.5mm terminal block with cover, O/P : 8P/9.5mm terminal block with cover			
	Power OK signal	Open Darin. Max 30Vdc / 0.1A			
	Cooling	Free Air convection for 400W, With 23.5CFM Fan for 500W			
	MTBF (MIL-HDBK-217F)	88.188 Khours			
	ON/OFF Remoter Control	Two modes setup remoter ON/OFF see Function Description of J2			
	Remoter Voltage sense	Compensates for wire voltage drop			
	Dimension (W*H*D)(mm)	254x127x38			
Packing	1.7kg : 12Pcs / 20.4KG				
Note	<p>1. All parameters NOT specially mentioned are measured at 230VAC input, rated load and 25°C of ambient temperature.</p> <p>2. Ripple & noise are measured at 20MHz of bandwidth by using a 12" twisted pair-wire terminated with a 0.1uf & 47 uf parallel capacitor.</p> <p>3. Tolerance: includes set up tolerance, line regulation and load regulation.</p> <p>4. De-rating may be needed under low input voltages. Please check the de-rating curve for more details.</p> <p>5. The power supply is considered a component which will be installed into a final equipment. The final equipment must be re-confirmed that it still meets EMC directives.</p>				

Mechanical Specification

Unit : mm

AC Input Terminal(CN1)Pitch:9.5mm:

Pin. No.	Assignment	
1	Live	AC/L
2	Neutral	AC/N
3	Ground/Earth	FG

Connector pin number assignment(CN2):
 JST B8B-PHDSS or equivalent

Pin. No.	Assignment	Mating Housing	Terminal
1	VS+	JST PHD-08VS or equivalent	JST SPHD-002T-P05 or equivalent
2	S GND		
3	INH-		
4	NC		
5	VS-		
6	POK		
7	INH+		
8	VS-		

External FAN Power Connector(CN3):

Pin. No.	Assignment	Mating Housing	Terminal
1	SGND	JST XHP-2 or equivalent	JST SXH-001T-0.6 or equivalent
2	12V+		

DC Output Terminal (CN4) pitch:9.5mm:

Pin. No.	Assignment	
1	VO(-)	Return
2	VO(-)	Return
3	VO(-)	Return
4	VO(-)	Return
5	VO(+)	+Main Output
6	VO(+)	+Main Output
7	VO(+)	+Main Output
8	VO(+)	+Main Output

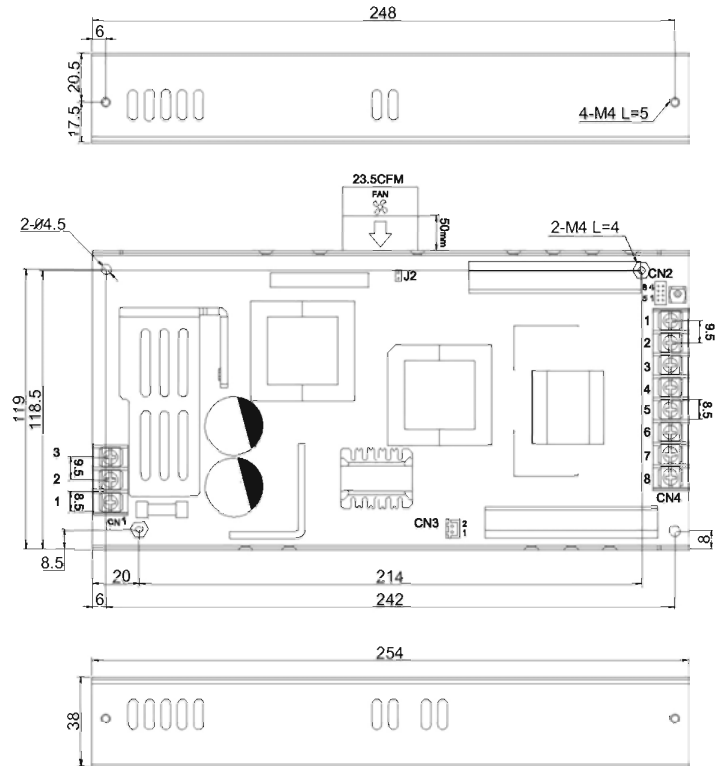

Block Diagram

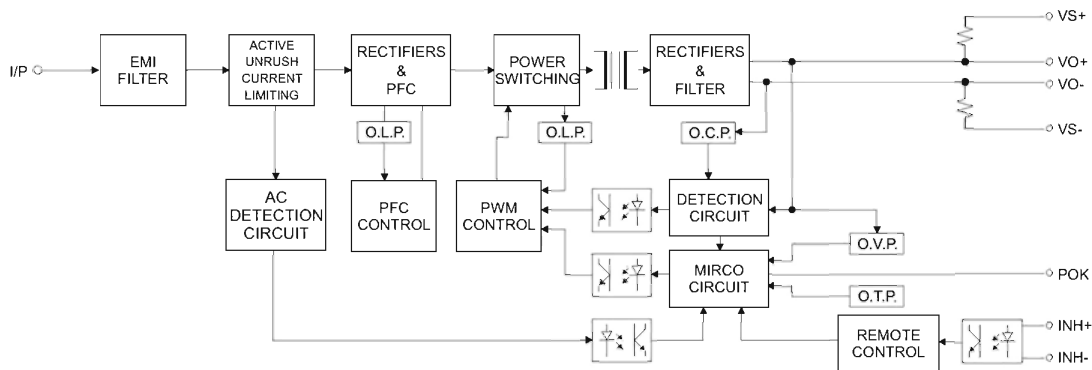

De-rating Curve

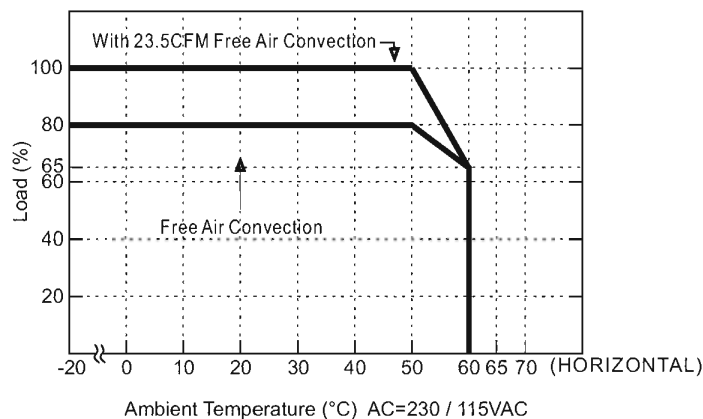

Static Characteristics

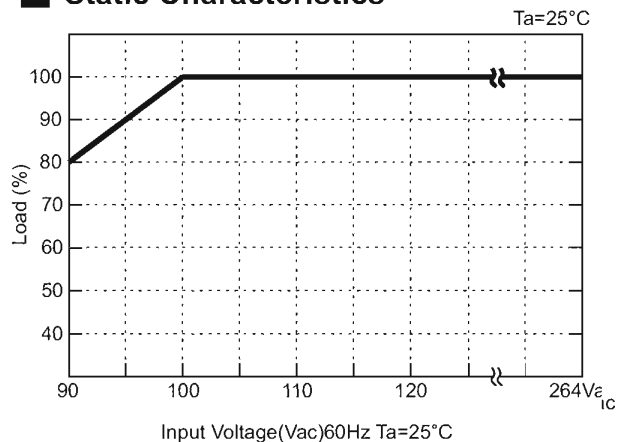

Function Description of CN2, CN3

CN2 PIN CONNECTIONS		
1	VS+	Remote Sense VO (+)
2	S GND	Signal Common
3	INH-	Remote ON/OFF Signal (-)
4	N.C	N.C
5	VS-	Remote Sense VO (-)
6	POK	Power OK signal control
7	INH+	Remote ON/OFF Signal (+)
8	VS-	Remote Sense VO (-)

CN3 PIN CONNECTIONS		
1	SGND	Return
2	12V+	FAN Voltage MAX:0.8A

Function Description of J2

1. Remote Control

The PSU can be turned ON/OFF by using the "Remote Control" function.

J2 PIN & CN2 CONNECTIONS		
J2	INH+(7 PIN)/INH-(3 PIN)	Output Status
Open	SW ON (>2.5V)	ENABLE
Open	SW OFF (<0.8V)	DISABLE
Close	SW ON (>2.5V)	DISABLE
Close	SW OFF (<0.8V)	ENABLE

(Default Setting)

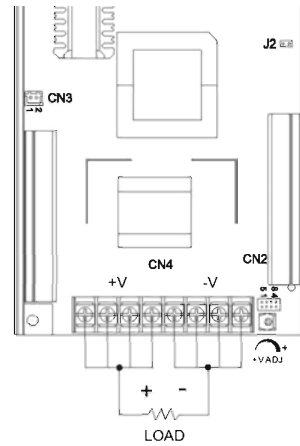
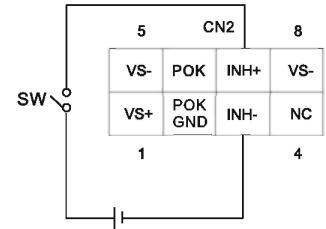

Fig 1.1



External Power Source I=6~20mA

Function Description of CN2

2.P-OK CONTROL

POK Signal use open drain MOSFET control
 MAX:30Vds,0.1A

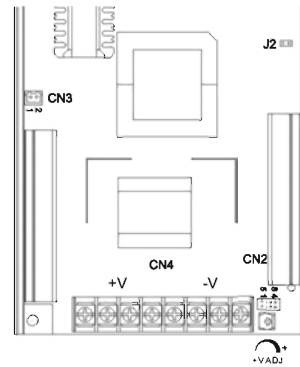
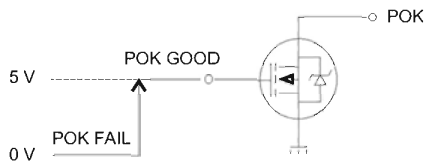
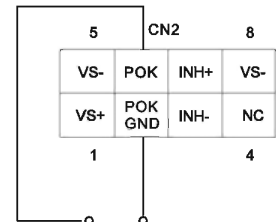

Fig 2.1



3. Remote Sense

The remote sensing compensates voltage drop on the load wiring up to 0.5V.

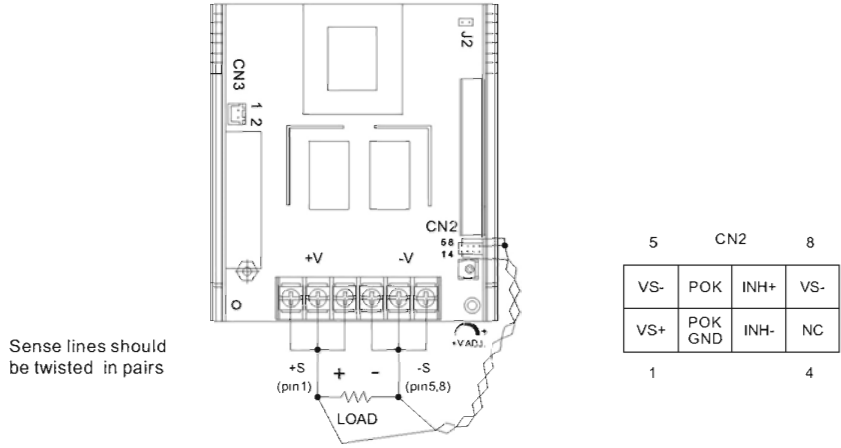

Fig 3.1